

MS2602A
Spectrum Analyzer
Operation Manual Vol.2
(Detailed Operating Instructions)

Eleventh Edition

Read this manual before using the equipment.
Keep this manual with the equipment.

Measuring Instruments Division
Measurement Group

ANRITSU CORPORATION

JUN.
1999

Document No.: M-W0653AE-11.0

Safety Symbols

To prevent the risk of personal injury or loss related to equipment malfunction, Anritsu Corporation uses the following safety symbols to indicate safety-related information. Insure that you clearly understand the meanings of the symbols **BEFORE** using the equipment.

Symbols used in manual

- DANGER** This indicates a very dangerous procedure that could result in serious injury or death if not performed properly.
- WARNING** This indicates a hazardous procedure that could result in serious injury or death if not performed properly.
- CAUTION** This indicates a hazardous procedure or danger that could result in light-to-severe injury, or loss related to equipment malfunction, if proper precautions are not taken.

Safety Symbols Used on Equipment and in Manual

(Some or all of the following five symbols may not be used on all Anritsu equipment. In addition, there may be other labels attached to products which are not shown in the diagrams in this manual.) The following safety symbols are used inside or on the equipment near operation locations to provide information about safety items and operation precautions. Insure that you clearly understand the meanings of the symbols and take the necessary precautions **BEFORE** using the equipment.



This indicates a prohibited operation. The prohibited operation is indicated symbolically in or near the barred circle.



This indicates an obligatory safety precaution. The obligatory operation is indicated symbolically in or near the circle.



This indicates warning or caution. The contents are indicated symbolically in or near the triangle.



This indicates a note. The contents are described in the box.

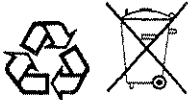

These indicate that the marked part should be recycled.

MS2602A Spectrum Analyzer
Operation Manual Vol.2 (Detailed Operating Instructions)

December 1992 (First Edition)
April 1999 (Eleventh Edition)

Copyright © 1992 – 1999 by Anritsu Corporation

All rights reserved. No part of this manual may be reproduced without the prior written permission of Anritsu Corporation.

The contents of this manual may be changed without prior notice.

Printed in Japan

For Safety



DANGER

NEVER touch parts where the label shown on the left is attached. Such parts have high voltages of at least 1 kV and there is a risk of receiving a fatal electric shock.



Repair

WARNING 

Falling Over

Battery Fluid

WARNING

1. Always refer to the operation manual when working near locations at which the alert mark shown on the left is attached. If the operation, etc., is performed without heeding the advice in the operation manual, there is a risk of personal injury. In addition, the equipment performance may be reduced.

Moreover, this alert mark is sometimes used with other marks and descriptions indicating other dangers.

2. This equipment cannot be repaired by the user. DO NOT attempt to open the cabinet or to disassemble internal parts. Only Anritsu-trained service personnel or staff from your sales representative with a knowledge of electrical fire and shock hazards should service this equipment. There are high-voltage parts in this equipment presenting a risk of severe injury or fatal electric shock to untrained personnel. In addition, there is a risk of damage to precision parts.
3. This equipment should be used in the correct position. If the cabinet is turned on its side, etc., it will be unstable and may be damaged if it falls over as a result of receiving a slight mechanical shock.
4. DO NOT short the battery terminals and never attempt to disassemble it or dispose of it in a fire. If the battery is damaged by any of these actions, the battery fluid may leak.

This fluid is poisonous.

DO NOT touch it, ingest it, or get in your eyes. If it is accidentally ingested, spit it out immediately, rinse your mouth with water and seek medical help. If it enters your eyes accidentally, do not rub your eyes, irrigate them with clean running water and seek medical help. If the liquid gets on your skin or clothes, wash it off carefully and thoroughly.

For Safety

CAUTION

Cleaning



Check Terminal



1. Keep the power supply and cooling fan free of dust.
 - Clean the power inlet regularly. If dust accumulates around the power pins, there is a risk of fire.
 - Keep the cooling fan clean so that the ventilation holes are not obstructed. If the ventilation is obstructed, the cabinet may overheat and catch fire.
2. Use two or more people to lift and move this equipment, or use a trolley. There is a risk of back injury, if this equipment is lifted by one person.
3. Never input a signal of more than DC 0 V between the measured terminal and ground. Input of an excessive signal may damage the equipment.

Refer to the Section 2 in Basic operating instructions of Operation manual, except the above descriptions.

Equipment Certificate

Anritsu Corporation certifies that this equipment was tested before shipment using calibrated measuring instruments with direct traceability to public testing organizations recognized by national research laboratories including the Electrotechnical Laboratory, the National Research Laboratory of Metrology and the Communications Research Laboratory, and was found to meet the published specifications.

Anritsu Warranty

Anritsu Corporation will repair this equipment free-of-charge if a malfunction occurs within 1 year after shipment due to a manufacturing fault, provided that this warranty is rendered void under any or all of the following conditions.

- The fault is outside the scope of the warranty conditions described in the operation manual.
- The fault is due to mishandling, misuse, or unauthorized modification or repair of the equipment by the customer.
- The fault is due to severe usage clearly exceeding normal usage.
- The fault is due to improper or insufficient maintenance by the customer.
- The fault is due to natural disaster including fire, flooding, earthquake, etc.
- The fault is due to use of non-specified peripheral equipment, peripheral parts, consumables, etc.
- The fault is due to use of a non-specified power supply or in a non-specified installation location.

In addition, this warranty is valid only for the original equipment purchaser. It is not transferable if the equipment is resold.

Anritsu Corporation will not accept liability for equipment faults due to unforeseen and unusual circumstances, nor for faults due to mishandling by the customer.

Anritsu Corporation Contact

If this equipment develops a fault, contact Anritsu Corporation or its representatives at the address in this manual.

'IBM' is a registered trademark of the IBM Corporation.
'HP' is a registered trademark of the Hewlett-Packard Company.
'MS-DOS' is a registered trademark of the Microsoft Corporation.
'NEC' is a registered trademark of the NEC Corporation.

ABOUT DETECTION MODE

This instrument is a spectrum analyzer which uses a digital storage system. The spectrum analyzer makes level measurements in frequency steps obtained by dividing the frequency span by the number of measurement data points (501 or 1002). This method of measurement cannot detect the signal peak level if the spectrum of a received signal is narrower than these frequency steps.

To resolve this problem, this instrument usually operates in positive peak detection mode. In this mode, the highest level within the frequency range between the sample points can be held and traced.

Positive peak detection mode should be used for almost all measurements including normal signal level measurement, pulsed noise analysis, and others. It is impossible to measure the signal level accurately in sample detection mode or in negative peak detection mode.

Use of sample detection mode is restricted to random noise measurement, occupied frequency bandwidth measurement for analog communication systems, and adjacent-channel leakage power measurement, etc.

Measurement item	Detection mode
● Normal signal level	POS PEAK
● Random noise	SAMPLE
● Pulsed noise	POS PEAK
● Occupied frequency bandwidth, adjacent-channel leakage power (for analog communication systems)	SAMPLE
● Occupied frequency bandwidth, adjacent-channel leakage power (for digital communication systems)	POS PEAK or SAMPLE

When a detection mode is specified as one of the measurement methods, make the measurement in the specified detection mode.

MEMORY BACK-UP BATTERY REPLACEMENT

The power for memory back-up is supplied by a Poly-carbomonofluoride Lithium Battery. This battery should only be replaced by a battery of the same type; since replacement can only be made by Anritsu, contact the nearest Anritsu representative when replacement is required.

STORAGE MEDIUM

This equipment stores data and programs using Plug-in Memory cards (PMC) and backed-up memories. Data and programs may be lost due to improper use or failure. ANRITSU therefore recommends that you back-up the memory.

ANRITSU CANNOT COMPENSATE FOR ANY MEMORY LOSS.

Please pay careful attention to the following points. Do not remove the IC card and backed-up memory from equipment being accessed.

(PMC)

- Isolate the card from static electricity.
- The back-up battery in the SRAM card has a limited life; replace the battery periodically.

(Backed-up memory)

- Isolate the memory from static electricity.

Note: The battery life is about 7 years. Early battery replacement is recommended.

Compatible Video Printers

Up until the present, this instrument recommended that you use the UA455A (Nippon Aleph corp.) as a video printer for measurement screen hard copies. However, a hardware upgrade for this instrument has made it possible to also use the following video printer:

Manufacturer: Seikosha Corp.

Model Name: VP-1500 II Video Printer

Release Date for Compatible Model: end of February 1996

Model Numbers: starting from MT81153

CE Marking

Anritsu affix the CE Conformity Marking on the following product (s) in accordance with the Council Directive 93/68/EEC to indicate that they conform with the EMC directive of the European Union (EU).

CE Conformity Marking



1. Product Name/Model Name

Product Name: Spectrum Analyzer

Model Name: MS2602A

2. Applied Directive

EMC: Council Directive 89/336/EEC

Safety: Council Directive 73/23/EEC

3. Applied Standards

EMC:

Electromagnetic radiation:

EN55011 (ISM, Group 1, Class A equipment)

Immunity:

EN50082-1

Performance criteria*

IEC801-2 (ESD) 4 kVCD, 8 kVAD

B

IEC801-3 (Rad.) 3 V/m

A

IEC801-4 (EFT) 1 kV

B

*: Performance criteria

A: No performance degradation or function loss

B: Self-recovered temporary degradation of performance or temporary loss of function

Harmonic current emissions:

EN61000-3-2 (Class A equipment)

Safety: EN61010-1 (Installation Category II, Pollution Degree 2)

ABOUT THIS MANUAL

(1) Composition of MS2602A Operation Manuals

The MS2602A Spectrum Analyzer operation manuals of the standard type are composed of the following three documents. Use them properly according to the usage purpose.

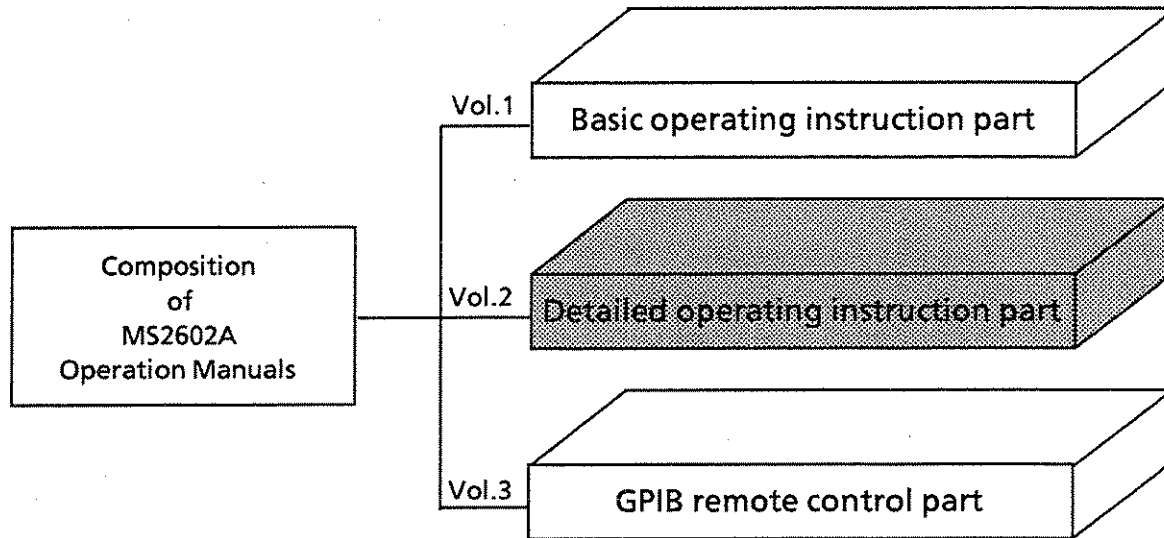

Basic operating instruction part:

Basic Operating Instructions: Provides information on the MS2602A outline, preparation before use, panel description, basic operation, performance tests, calibration, storage / transportation, and quick reference for functions other than PTA.

Detailed operating instruction part:

Detailed Operating Instructions: Provides information on the detailed operating instructions that expand on the panel description and basic operation in the Basic Operating Instruction Part of the separate Operation Manual. An index is available for the function menu to facilitate quick reference.

GPIB remote control part:

Provides information on the MS2602A remote control which conforms with IEEE488.2 standards. To assist creating GPIB programs, this manual gives examples of N88 Basic language programs that run on the Nippon Electric Co.(NEC) PC9800 series of personal computers.

(2) GPIB Basic Guide (sold separately)

The GPIB Basic Guide is sold separately in addition to the above GPIB operation manual. It is composed of two parts: GPIB Basic Knowledge, and GPIB Control statements in the ANRITSU PACKET V BASIC.

TABLE OF CONTENTS

For Safety	iii
SECTION 1	BASIC OPERATING INSTRUCTIONS	1-1
1.1	Initial Power - On	1-3
1.2	CRT Screen	1-6
1.2.1	CRT Screen at Preset	1-6
1.2.2	CRT Screen at General Measurements	1-9
1.3	Pre-measurement Calibration	CALIBRATION 1-10
1.4	Measurement Example	1-11
1.4.1	Checking the receiving frequency band	ZONE MARKER 1-11
1.4.2	Moving measurement signal to center PEAK → CF, AUTO TUNE, CENTER, MKR → CF	1-13
1.4.3	Expanding and compressing measurement signal waveform	SPAN 1-17
1.4.4	Measuring signal level	CAL, PEAK → CF / REF 1-18
1.5	Hard Copying Measurements Screen with Video Plotter	1-19
SECTION 2	FREQUENCY / AMPLITUDE DATA ENTRY	2-1
2.1	Setting Observation Frequency	2-3
2.1.1	CENTER-SPAN mode	2-4
2.1.2	START-STOP mode	2-5
2.1.3	START-SPAN mode	2-6
2.1.4	Setting step size with step keys	2-7
2.1.5	Moving observation frequency with scroll keys	2-8
2.1.6	Selecting the fixed frequency band	2-10
2.1.7	Setting full span	2-11
2.1.8	Setting zero span	2-11
2.1.9	Setting the FINE ADJ	2-12
2.2	Setting Level Range	2-13
2.2.1	Setting log / linear scale	2-14
2.2.2	Selecting reference level units	2-15
2.2.3	Setting reference level	2-16
2.2.4	Setting reference level step size	2-17
2.3	Offsetting Reference Level	2-18

SECTION 3	MARKER FUNCTION	3-1
3.1	Changing Zone Marker Position and Width	3-3
3.1.1	Changing zone marker width	3-4
3.1.2	Changing zone marker position	3-6
3.2	Marker Mode	3-7
3.2.1	Current marker	3-7
3.2.2	Delta marker	3-8
3.2.3	Multimarker	3-9
3.2.4	Marker OFF	3-12
3.3	Marker Search	3-13
3.3.1	PEAK search	3-13
3.3.2	NEXT PEAK search	3-14
3.3.3	MIN DIP search	3-15
3.3.4	NEXT DIP search	3-16
3.3.5	NEXT RIGHT PEAK search / NEXT LEFT PEAK search	3-17
3.4	Setting Parameters Using Marker Values	3-18
3.4.1	MKR → CF / MKR → REF	3-19
3.4.2	MKR → CF STEP SIZE	3-20
3.4.3	△MKR → SPAN	3-21
3.4.4	ZONE → SPAN	3-22
3.5	Display Line	3-23
3.5.1	Setting the display line	3-23
3.5.2	Displaying the marker level from the reference position of the display line	3-24
SECTION 4	SIGNAL SEARCH FUNCTION	4-1
4.1	Detecting Peaks	4-3
4.1.1	Detecting the maximum peak signal by automatic tuning	4-3
4.2	Moving the Measurement Point	4-4
4.2.1	PEAK → CF and PEAK → REF	4-5
SECTION 5	SELECTING THE DISPLAY METHOD	5-1
5.1	DISPLAY Mode	5-3
5.1.1	Trace A	5-5
5.1.2	Trace B	5-6
5.1.3	Trace Time	5-7
5.1.4	Trace A / Trace B	5-8
5.1.5	Trace A / Trace BG	5-9
5.1.6	Trace A / Trace Time	5-10

5.2	Storage Mode	5-11
5.2.1	Selecting storage mode	5-13
5.2.2	Setting storage mode during simultaneous display mode	5-14
5.2.3	Digital video averaging	5-15
5.3	Detection Mode	5-18
5.3.1	Selecting detection mode	5-19
5.3.2	Selecting the measured level by detection mode	5-20
5.4	Time Domain	5-21
5.4.1	Setting time domain	5-21
5.4.2	Setting TIME SPAN	5-22
5.4.3	EXPAND functions	5-23
5.4.4	Monitoring FM demodulation waveforms	5-25
5.4.5	Monitoring external trigger signal	5-27
SECTION 6	SELECTING SWEEP METHOD	6-1
6.1	Sweep Mode	6-3
6.1.1	Continuous sweep mode	6-3
6.1.2	Single sweep mode	6-4
6.1.3	Stopping the sweep	6-4
6.2	Trigger Mode	6-5
6.2.1	FREE RUN	6-5
6.2.2	TRIGGERED	6-6
6.2.3	Delay time	6-10
6.3	Zone Sweep and Signal Tracking	6-12
6.3.1	Zone sweep	6-12
6.3.2	Signal tracking	6-13
6.4	Analyzing Spectrum by Time Gate Analysis	6-14
6.4.1	Creating a gate control signal	6-17
SECTION 7	COUPLED FUNCTION	7-1
7.1	Individual Coupled Functions	7-4
7.1.1	Resolution bandwidth / sweep time	RBW / Swp Time 7-5
7.1.2	Video Bandwidth	VBW 7-8
7.1.3	Input attenuator	Atten 7-9
7.2	Coupled Mode	7-10

SECTION 8	AUTOMATIC CALIBRATION AND PRESELECTOR TUNING	8-1
8.1	Automatic Calibration Function	CAL 8-3
8.1.1	Calibration items	8-5
8.2	Preselector Tuning	8-6
8.3	Measurement System Correction	8-8
SECTION 9	SETTING MEASUREMENT SYSTEM	9-1
9.1	Measurement System Settings	9-3
9.1.1	Sweep time setting conditions in Auto mode	AUTO SWT 9-3
9.1.2	Number of data points	DATA POINTS 9-4
9.1.3	Common / independent settings for coupled function between frequency domain and time domain	COUPLE MODE 9-6
9.2	Setting the date and time	9-8
9.2.1	Setting the date	9-8
9.2.2	Setting the time	9-8
9.2.3	Setting the display format of the date	9-8
SECTION 10	SAVE / RECALL FUNCTION	10-1
10.1	SAVE / RECALL to Internal Memory	10-5
10.1.1	SAVE	10-5
10.1.2	RECALL	10-6
10.2	Saving / Recalling and Managing the PMC File	10-7
10.2.1	Selecting media	10-7
10.2.2	Formatting the PMC file	10-8
10.2.3	SAVE	10-8
10.2.4	RECALL	10-9
10.2.5	Displaying the directory	10-10
10.2.6	Write protection	10-11
10.2.7	Deleting a file	10-11
10.2.8	PMC error messages	10-12
SECTION 11	COPY / SOUND MONITOR	11-1
11.1	Direct Plotting	11-3
11.1.1	Connecting to a printer / plotter	11-3
11.1.2	Selecting a printer	11-4
11.1.3	Selecting and setting a plotter	11-5
11.1.4	Hard-copying	11-10
11.2	Displaying the Title	11-11
11.3	List of Measurement Parameters and System Settings	11-13

11.4	SOUND Monitor	11-14
11.4.1	Sound monitor from AM wave	11-15
11.4.2	Sound monitor from FM wave	11-15
SECTION 12	INTERFACE / PMC	12-1
12.1	Interface with External Devices	12-3
12.1.1	Using GP-IB1 and GP-IB2	12-3
12.1.2	Setting GPIB address	12-4
12.2	PMC	12-5
12.2.1	Selecting media	12-5
12.2.2	Formatting media	12-6
12.2.3	Managing media	12-7
SECTION 13	MEASUREMENT	13-1
13.1	General Precautions on Measurement	13-3
13.1.1	Input signal level range	13-3
13.1.2	Dynamic range	13-4
13.2	General Measurement Procedure	13-6
13.2.1	Auto Tune function	13-6
13.2.2	A / BG, Peak → CF, Peak → Ref	13-7
13.3	Measuring Spurious Harmonics	13-8
13.3.1	Measuring fundamental waves and harmonics on the same screen	13-8
13.3.2	Measuring low-level harmonics	13-9
13.4	Measuring Modulated Waves	13-13
13.4.1	Measuring AM modulation factor	13-13
13.4.2	FM peak deviation	13-17
13.4.3	Pulse modulated wave	13-21
13.5	Measuring Intermodulation Distortion	13-23
13.6	Measuring Frequency	13-25
13.7	Measuring Noise Level	13-27
13.7.1	Absolute value measurement of noise power	13-27
13.7.2	Carrier signal vs. noise power measurement	13-28
13.7.3	C / N measurement	13-29
13.8	Occupied Frequency Bandwidth Measurement	13-31
13.8.1	Occupied frequency bandwidth measurement by the X dB DOWN method	13-32
13.8.2	Occupied frequency bandwidth measurement by the N% of POWER method	13-34

13.9	Adjacent-channel Leakage Power Measurement	13-36
13.9.1	Adjacent channel leakage power measurement in which a channel is specified	13-39
13.9.2	Adjacent leakage power measurement in which a graph is displayed	13-42
13.10	Burst Signal Measurement (Go / No-Go Decision by Template Data) ...	13-45
13.10.1	Outline of template decision	13-45
13.10.2	Template data selection and go / no-go decision	13-46
13.10.3	Creating template data	13-48
13.10.4	Changing template data	13-54
13.10.5	Moving the template	13-56
13.11	Burst Signal Measurement (Average Power Measurement)	13-57
13.12	Setting the Measure Window Display Position	13-59
SECTION 14	SOFT KEY MENU INDEX	14-1
APPENDIX A	MS2602A BLOCK DIAGRAM	A-1
APPENDIX B	LIST OF ABBREVIATIONS ON PANEL AND DISPLAY	B-1
APPENDIX C	CONNECTION TO UA-455A VIDEO PLOTTER	C-1
APPENDIX D	CONNECTING VP-1500II VIDEO PRINTER	D-1
APPENDIX E	HOW TO USE AN EXTERNAL DISPLAY	E-1
APPENDIX F	PANEL DESCRIPTION	F-1

SECTION 1

BASIC OPERATING INSTRUCTIONS

This section explains the basic MS2602A operations to start using the MS2602A. The range of basic operations is confined to the minimum necessary items that allow quick and simple confirmation of the basic operation and basic functions of the MS2602A.

TABLE OF CONTENTS

1.1	Initial Power - On		1-3
1.2	CRT Screen		1-6
	1.2.1 CRT Screen at Preset		1-6
	1.2.2 CRT Screen at General Measurements		1-9
1.3	Pre-measurement Calibration	CALIBRATION	1-10
1.4	Measurement Example		1-11
	1.4.1 Checking the receiving frequency band	ZONE MARKER	1-11
	1.4.2 Moving measurement signal to center PEAK → CF, AUTO TUNE, CENTER, MKR → CF		1-13
	1.4.3 Expanding and compressing measurement signal waveform	SPAN	1-17
	1.4.4 Measuring signal level	CAL, PEAK → CF / REF	1-18
1.5	Hard Copying Measurements Screen with Video Plotter		1-19

SECTION 1

BASIC OPERATING INSTRUCTIONS

1.1 Initial Power-On

The MS2602A has two power switches: a front-panel [Power On / Stby] switch and a rear-panel [LINE On / Off] switch.

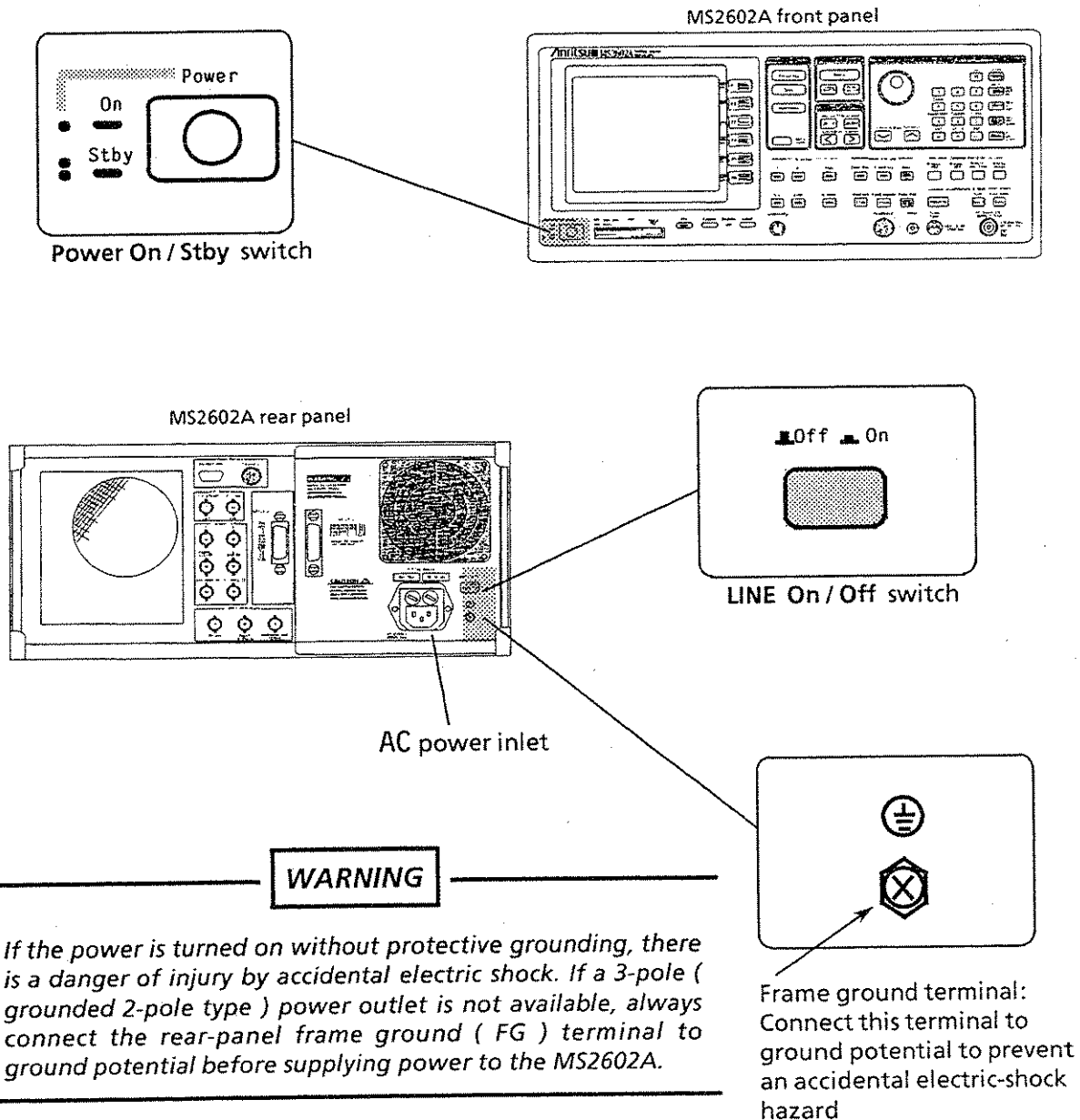

CAUTION

*If the AC line voltage is unsuitable, the MS2602A may be damaged by an abnormal voltage. Before turning on the power, confirm that the AC line voltage is the rated value *** Vac.*

In normal use, to warm-up the internal reference oscillator, leave the [LINE On / Off] switch in the ON position with the supplied power cord connected to the MS2602A AC power inlet and line power outlet, and turn on the power with the front-panel [Power On / Stby] switch only.

The procedure described below is for the initial power-up to normal use through warming-up of the internal reference oscillator.

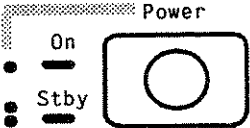
Step	Action	Verification
1	Ground the rear-panel frame ground terminal.	<ul style="list-style-type: none"> • This grounding is not necessary when a 3-pole power cord is used with a grounded outlet.
2	Check that the AC line voltage from the AC line outlet is correct.	<ul style="list-style-type: none"> • The allowable AC line voltage ranges from 100 to 120 Vac for 100 Vac system, and from 200 to 230 Vac for 200 Vac system.
3	 <p>Set the rear-panel [LINE On / Off] switch to Off.</p>	<ul style="list-style-type: none"> • When this button is depressed, the AC line is set to On. To turn the line Off, press the button again so that it pops out.
4	 <p>Set the front-panel [Power On / Stby] switch to Stby.</p>	<ul style="list-style-type: none"> • When this button is depressed, the power is set to On. To turn the power Off, press the button again so that it pops out.
5	Insert the power cord into the rear-panel power inlet.	<ul style="list-style-type: none"> • Insert the male end of the plug firmly so that a gap of about 1 to 2 mm is left as shown in the figure below.
6	Insert the power cord plug into the AC line outlet.	
7	Check that the rear-panel 10 MHz reference Output connector connected to Input connector with the U-link.	

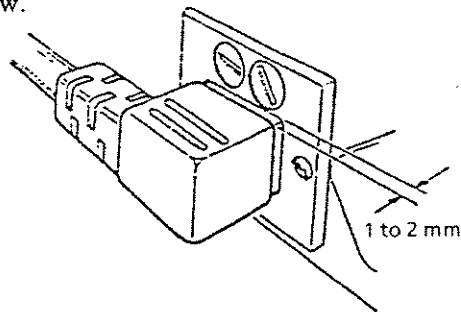

Step	Action	Verification
------	--------	--------------

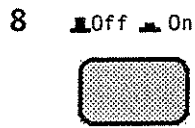

Set the rear-panel [LINE On / Off] switch to ON.

- The front-panel [Power] switch Stby lamp lights.
- Warming-up of the internal reference crystal oscillator starts. The reference crystal oscillator stability is shown in the table below.

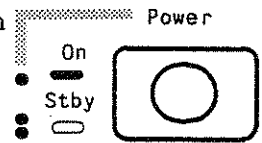

Reference crystal oscillator stability

Item		Standard	Option 01
Starting characteristics	After 10-minute operation	5×10^{-8} /day max.	—————
	After 30-minute operation	—————	2×10^{-8} /day max.
Aging rate (after 24-hour operation)		2×10^{-8} /day max.	5×10^{-9} /day max.
Stability against crystal oscillator ambient temperature change ($25^\circ\text{C} \pm 25^\circ\text{C}$)		$\pm 5 \times 10^{-8}$ max.	$\pm 3 \times 10^{-8}$ max.

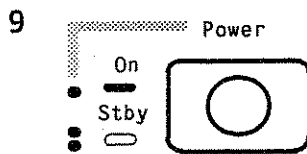

Set the front-panel [Power On / Stby] switch to On.

- The front-panel [Power] switch On lamp lights and the Stby lamp goes off.
- Power is supplied to all the MS2602A circuits and the MS2602A enters the ready state.

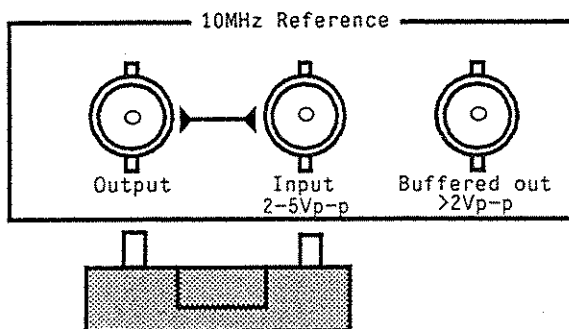
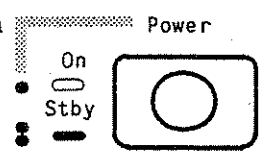

Note: When using the external reference crystal oscillator, disconnect the U-link connected between the rear-panel 10 MHz Reference Input connector and the Output connector shown on the left side and apply an external reference-crystal-oscillator output signal to the Input connector. In this case, warm-up the external oscillator separately because it is unrelated to the Stby lamp.

1.2 CRT Screen

When the power is turned on, the MS2602A fetches the panel function parameter settings when the power was lastly turned off.

These settings are displayed on the screen. The following two examples are described here.

- Displaying CRT screen at preset Initial state at factory setting
- Displaying CRT screen at general setting ... Setting state when used previously at the last time

1.2.1 CRT Screen at Preset

When the power is turned on for the first time after the MS2602A has been delivered, the initial parameters at factory settings are displayed.

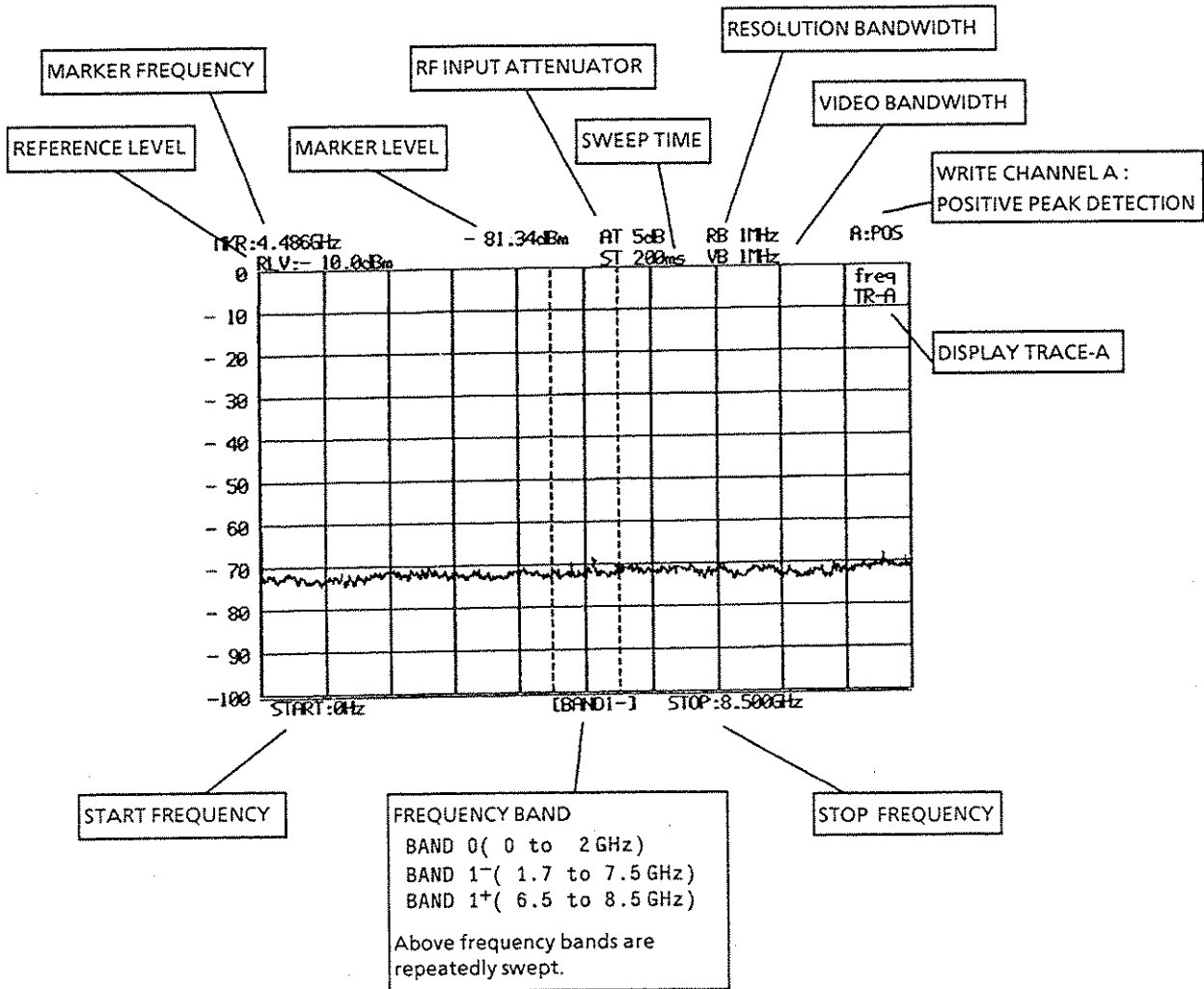

CRT Screen at Preset

When the [Preset] key shown in the circle below is pressed, the MS2602A is initialized to the same panel setting parameters as the preset screen display. However, initialization by the [Preset] has no effect on the following parameters which are backed-up.

- Internal calibration data
- Interface settings such as GPIB address
- Information on multimarkers positions
- SAVE/RECALL data
- SYSTEM menu
- LOG SCALE UNIT
- TITLE
- Printer mode
- Measure function setup
- Template data

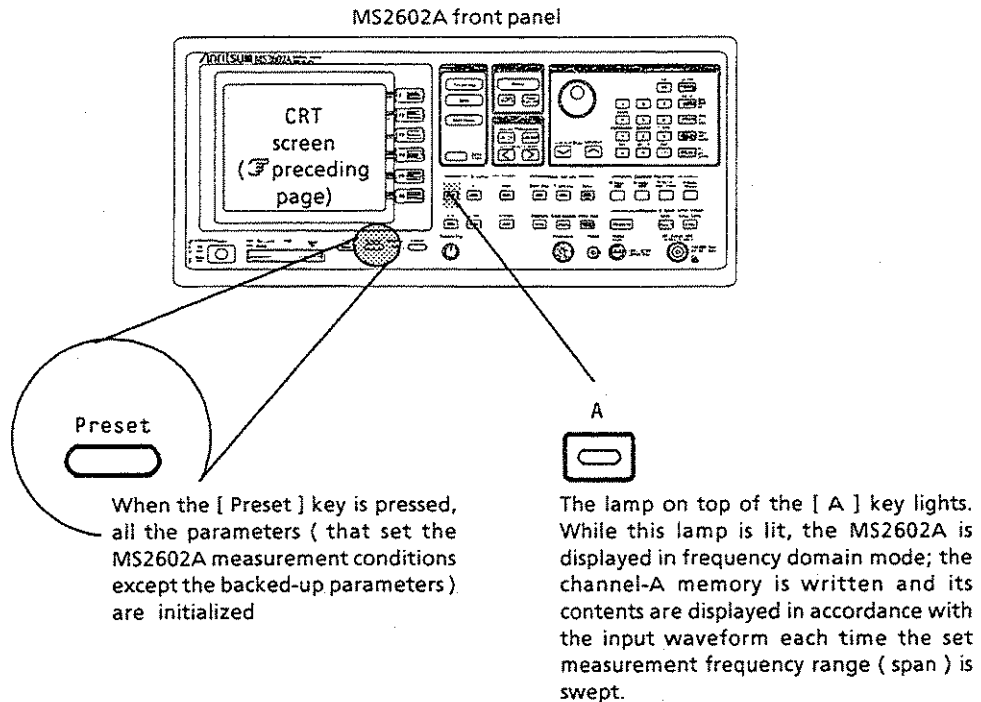

Initial Settings

To set all the MS2602A parameters to the factory settings even if they are not initialized by the above [Preset] key, set the Power switch to the On position while pressing the [Preset] key. Continue to press the [Preset] key until all lamps on the panel are lit.

For detailed parameters when all the measurement settings of the MS2602A are initialized, refer to Appendix A in the GPIB Remote Control part of the separate Operation Manual. The measurement parameters directly concerning the CRT screen are repeated on the following page.

Table of MS2602A Device-Dependent Initial Settings

Group	Brief function	Function item	Initial setting data		
			TRACE-A,B	TRACE-TIME	TRACE-BG
Frequency	Selects the mode for setting the frequency band	FREQUENCY MODE	START-STOP		
	Sets the start frequency	START FREQUENCY	0 Hz	-----	0 Hz
	Sets the center frequency	CENTER FREQUENCY	4.25 GHz		4.25 GHz
	Sets the stop frequency	STOP FREQUENCY	8.50 GHz	-----	8.50 GHz
	Sets the frequency span	FREQUENCY SPAN	8.50 GHz	*0 Hz	8.50 GHz
	Sets the center-frequency step size	CENTER FREQ STEP SIZE	1 GHz		
Level	Sets the reference level	REFERENCE LEVEL	-10 dBm		
	Sets the reference-level step size	REF LEVEL STEP SIZE	AUTO / 1 div		
	Selects the mode for setting the Y axis	SCALE MODE	LOG	LOG	LOG
	Set the LOG scale	LOG SCALE	10 dB / div	10 dB / div	*10 dB / div
	Sets the reference level offset	REF LEVEL OFFSET	OFF		
Coupled function	Selects the mode for setting the resolution bandwidth	RESOLUTION BANDWIDTH	AUTO	AUTO	*AUTO
	Selects the mode for setting the video bandwidth	VIDEO BANDWIDTH	AUTO	AUTO	*AUTO
	Selects the mode for setting the sweep time	SWEEP TIME	AUTO	AUTO	*AUTO
	Selects the mode for setting the RF attenuator	RF ATTENUATOR	AUTO		
Display mode	Selects the display format	DISPLAY MODE	TRACE-A		
Marker function	Selects the marker mode	MARKER MODE	NORMAL		
	Specifies the zone-marker center	ZONE MARKER CENTER	250 point	250 point	250 point
	Specifies the zone-marker width	ZONE MARKER WIDTH	501 point	*1 point	501 point
	Sets the multi marker mode	MULTI MARKER MODE	OFF		
	Sets the display line	DISPLAY LINE	OFF		
	Sets the display line level	LINE LEVEL	-50.00 dBm		
	Sets the marker level	MARKER LEVEL	ABS	ABS	ABS

Note: An initial value marked with "" represents the fixed value.*

1.2.2 CRT Screen at General Measurements

When the previous-used panel settings are not the factory settings or the initial settings by pressing [Preset] key, information not provided on the initial CRT screen is added as shown below. At normal panel setting, the following items are displayed on the screen.

- When a panel key is pressed, the menu is displayed at the right side of the screen. An example below shows the Frequency menu when the [Frequency] key is pressed.
- When an entry key is pressed, a communication field is displayed at the bottom of the screen. An example below also shows the center-frequency entry response at the communication field when the center frequency is set by pressing the [Frequency] key.
- The frequency setting parameters are displayed below the screen. The center frequency or the start frequency is displayed at the left side in the order of CENTER, value, units, or START, value, units. The frequency span or the stop frequency is displayed at the right side in the order of SPAN, value, units, or STOP, value, units.

In addition to those described above, there are two types of display modes in the frequency domain display waveform format: TRACE-A and TRACE-B. The CRT screen diagram below shows an example of a simultaneous display comparison of waveforms between TRACE-A and TRACE-B. In this figure, the TRACE-A frequency span is set to 100 kHz after the TRACE-B sweep waveform is set to the VIEW mode with the frequency span set to 20 kHz.

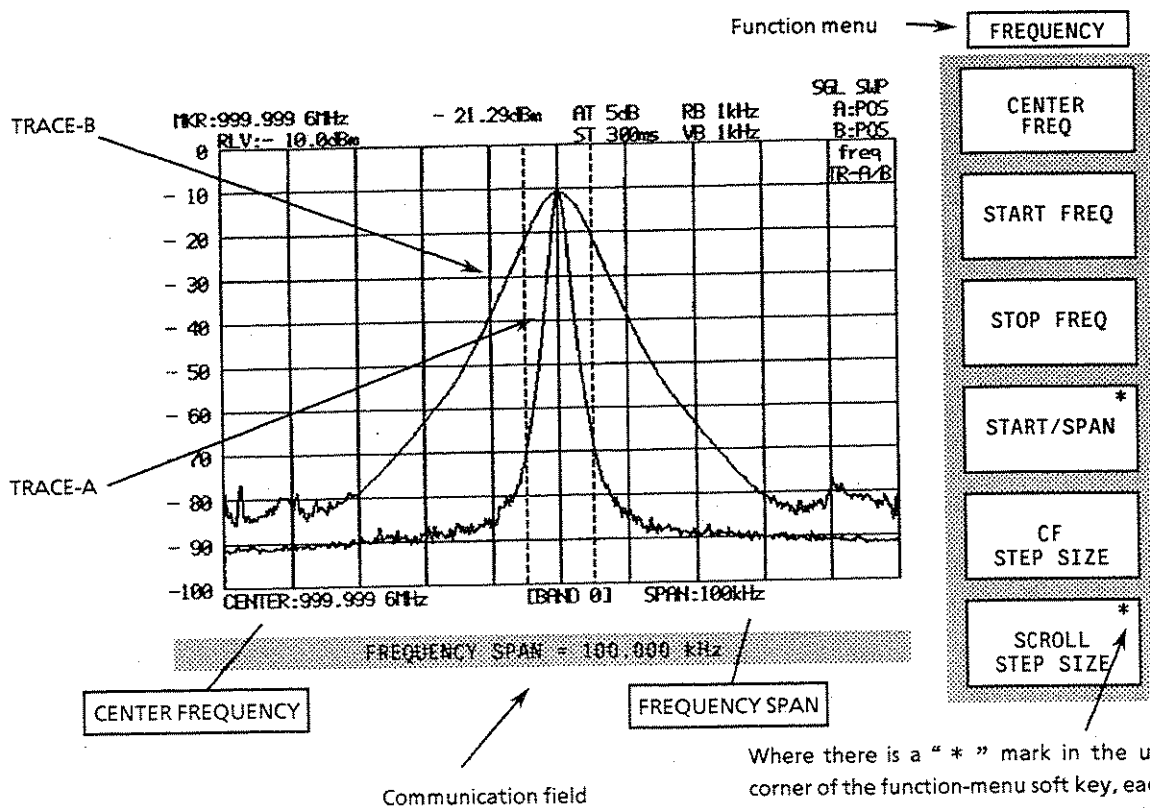

Where there is a "*" mark in the upper-right corner of the function-menu soft key, each time the soft key with this asterisk is pressed, the child function menus are displayed for more detailed menus (For how to read the function menu, see Appendix F)

CRT Screen at General Measurements

1.3 Pre-measurement Calibration CALIBRATION

Calibration is performed to minimize amplitude / frequency errors and to maintain measurement accuracy by executing an error correction routine in the MS2602A.

Calibration is not always necessary before each measurement but execute ALL CALIBRATION in the following cases as shown below before beginning measurement.

- ① After a 30-minutes warm-up after the power is turned on.
- ② When making measurements over a long period, when the measured data does not meet the specifications or when the frequency and amplitude errors caused by the switching of RBW, input ATT and SCALE, etc. cannot be ignored.

CAUTION

If calibration is performed with an external signal applied to the RF Input connector, the correct calibration value will not be obtained. Perform calibration with no signal applied to the RF Input connector.

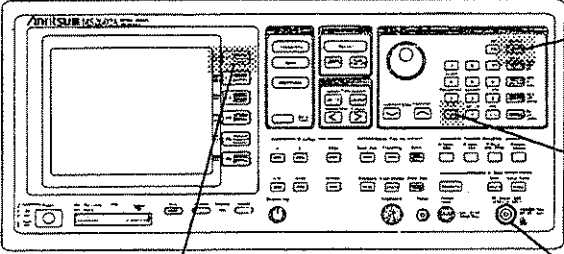

MS2602A front panel

RF Input



1 Press the  key.

- The [Shift] key lamp lights.

2 Press the  key.

- The calibration menu is displayed

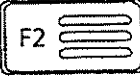
CALIBRATION

ALL	
LEVEL	
FREQ	

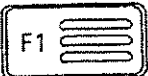
3 Press the  key.

- When the clockwise-rotating radius reaches the 12 o'clock position, calibration is completed. ALL CAL is completed in about 90 seconds.

CALIBRATING

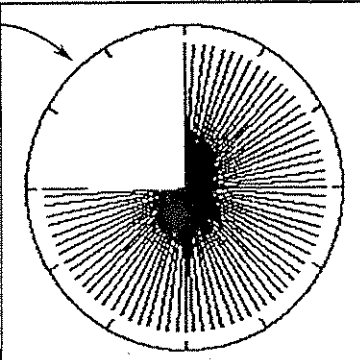

The blank space up to 12 o'clock shows the remaining calibration time.

Note: *The CAL data is backed-up by a battery not to be cleared even when the power is turned off and on. Measurement errors can be minimized by performing calibration at every opportunity.*

1.4 Measurement Example

The MS2602A 500 MHz check signal can be taken from the rear-panel 500MHz Output (-18dBm) connector. Using this check signal this paragraph describes the basic operations and the information required for it. The 500 MHz check signal is used to measure its fundamental frequency and level as a measurement example from start to finish.

The usage of this check signal is explained here to describe the basic measurement operation. Steps ① and ② below have already been explained.

- ① Power-on (initialization by [Preset])
- ② Calibration (ALL CALIBRATION)

The steps after step ② are explained below.

1.4.1 Checking the receiving frequency band ZONE MARKER

The screen display below indicates that the entire band between 0 and 8.5 GHz is being swept.

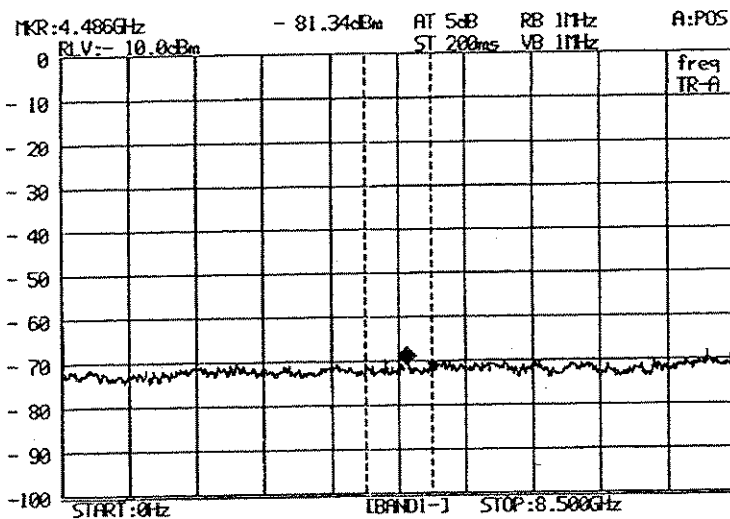

The frame enclosed with dotted lines appears at the center of the screen. This frame is called a zone marker. There is a current marker indicated with \blacklozenge in the zone marker. The current marker always shows the maximum value of the trace within the zone marker. The frequency and level at the current marker are digitally displayed on the top of the screen. The digital display of the marker shows a frequency of 4.486 GHz and a level of -81.34 dBm.

ZONE-MARKER center position = Point 250

Current marker position

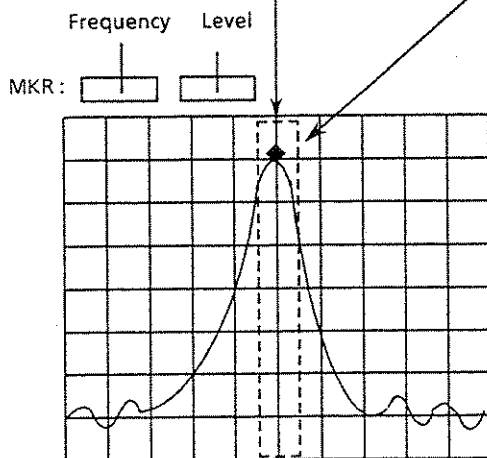

- ① The dotted-line frame itself is a zone marker that is treated as one marker, and is moved by the rotary knob (explained on the next page).
- ② The current marker always moves the maximum level within the frequency range indicated by the zone marker.
- ③ The frequency and level at the current marker are digitally displayed at the top of the screen.
- ④ The zone marker width can be changed (explained on the next page). When the marker width is set to SPOT, the width of the zone marker is equivalent to one Y-axis line where the position of the marker itself can be set by the rotary knob.

Verify the description on the previous page as shown below.

Marker mode / moving ZONE

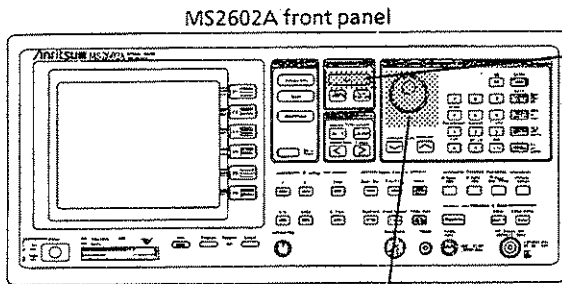

1 Press the **Marker** key.

- The MARKER menu is displayed.
- The double-frame label of NORMAL shows that the current marker mode is the NORMAL mode.

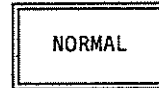

Rotary knob

- The entry response shown below is displayed at the communication field.







ZONE CENTER=4.250 000 000 GHz

- This shows that the center of the zone marker is 4.25 GHz.
- The zone marker can be moved from the left X axis side to the right X axis side with the rotary knob. (Setting is also possible with the numeric keypad.)
- The current marker is always at the peak level in the zone marker.

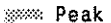
1.4.2 Moving measurement signal to center PEAK → CF, AUTO TUNE, CENTER, MKR → CF

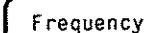
The MS2602A provides four typical methods for setting the desired spectrum in the center of the screen.

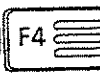
- PEAK → CF:** If the displayed zero-beat signal is the peak level, when Peak [→ CF] is pressed, it moves to the center of the screen with the zone marker. Therefore, do not include the zero-beat signal in the measurement range.
- AUTO TUNE:** Even if the objective peak is off the display, when it is in the specified band, it is detected and set to the REF LEVEL line automatically. The span is set to 100 MHz automatically if span is > 100 MHz. If the span is ≤ 100 MHz, it does not change.
- CENTER:** The center frequency is set with the numeric keypad or rotary knob.
- MKR → CF:** When the [F1] soft key corresponding to the [MKR → CF] label in the MKR → menu is pressed, the point indicated by the current marker is moved to the center of the screen together with the zone marker.

Item \ Function	PEAK→CF	AUTO TUNE	CENTER	MKR → CF
Object signal	Peak level	Peak level	Specified by frequency	Current marker
Search range	In displayed screen	In specified screen	In the entire band	In displayed screen
Zero-beat signal †	Measurable	Not measurable	Measurable	Measurable
Automatic REF level setting	No	Yes	No	No
Operation keys	 Peak 	 Auto Tune	 Frequency	 Marker  

† This is a signal unnecessary for measurement.

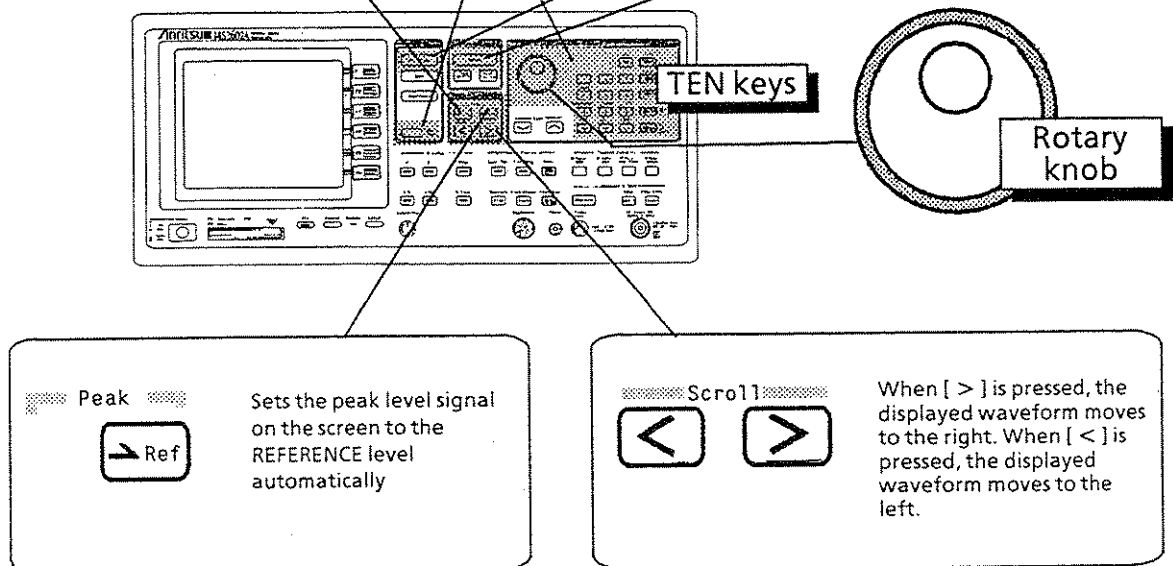

Try executing the functions described on the preceding page in the PEAK → CF, CENTER, MKR → CF, AUTO TUNE order. In addition, perform the start/stop and center / span operations.

Inputting 500 MHz check signal

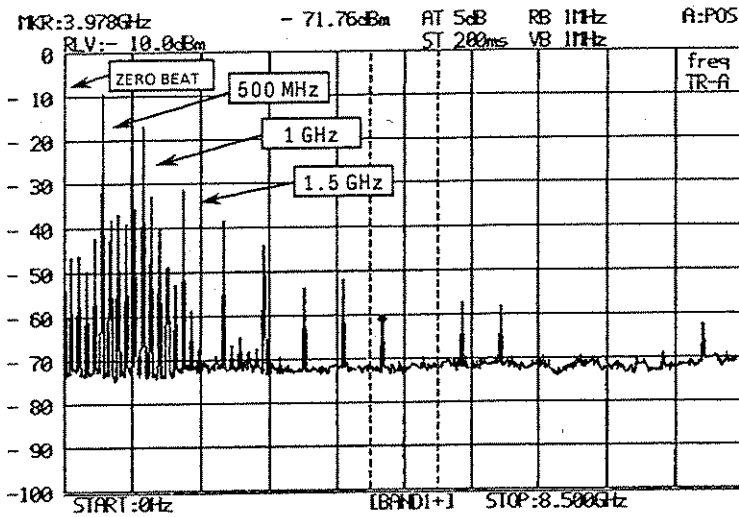

1 Connect the RF Input connector to the 500 MHz Output connector with the accessory cable.

- The spectrums are lined-up in the order of the zero-beat signal, 500 MHz fundamental wave, 1 GHz second harmonic, and 1.5 GHz third harmonic from the left side of the X-axis (START 0 Hz).

PEAK → CF / CENTER

If the PEAK → CF function is executed on the above screen, then the zero-beat signal moves to the center of the screen. To place the zero-beat signal outside the measurement range, change the scroll value or the center frequency so that the zero-beat signal cannot be seen on the screen. Then execute the PEAK → CF or MKR → CF function or set 500 MHz as the center frequency. The following procedure explains how to set 500 MHz as the center frequency.

1 Press the **Preset** key.

- START FREQ = 0 Hz, STOP FREQ = 8.5 GHz are set as shown above.

2 Press the **Frequency** key, **5** **0** **0** **MHz/sec** key.

- Since the center frequency is set to 500 MHz, the 500 MHz spectrum signal is positioned to the center of the screen.

MKR → CF

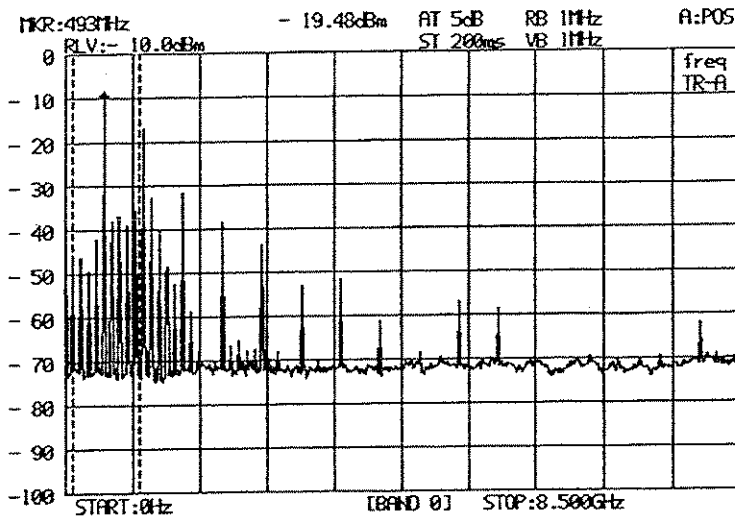

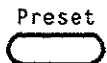
1 Press the  key.

- START FREQ = 0 Hz, STOP FREQ = 8.5 GHz are set. The screen display becomes the same as the preceding page.

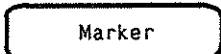
2 Press the  key.

- The zone marker can be moved with the rotary knob.

3 Turn the Rotary knob so that 500 MHz is in the zone marker.

- The current marker  position is the peak level of the 500 MHz fundamental wave in the zone marker. (See the figure above.)

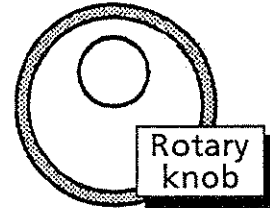

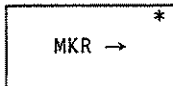
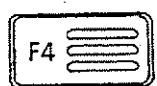
4 Press the   key.

- The PEAK MARKER menu is displayed.

MKR →CF

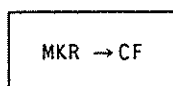
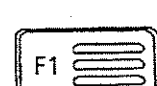
5 Press the   key.

- The frequency of 500 MHz at the current marker is set to the center frequency. The 500 MHz fundamental wave of step 2 is moved to the center of the screen
- The zone and current markers are moved to the center of the screen together with the spectrum.

Setting AUTO TUNE / REF LEVEL 0 dBm

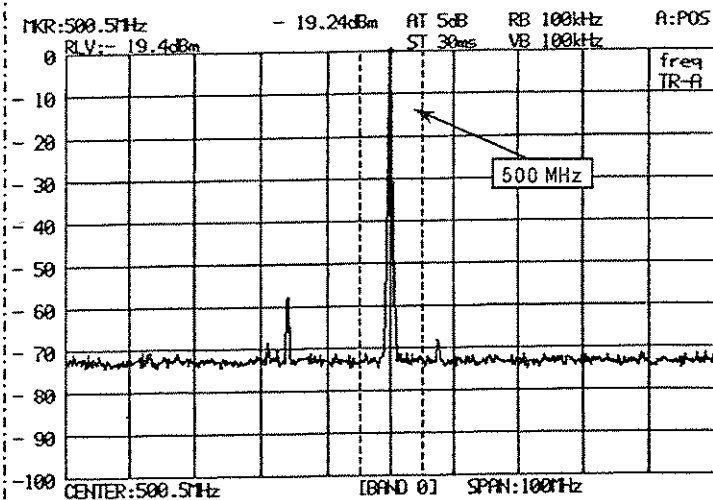

1 Press the **Preset** key.

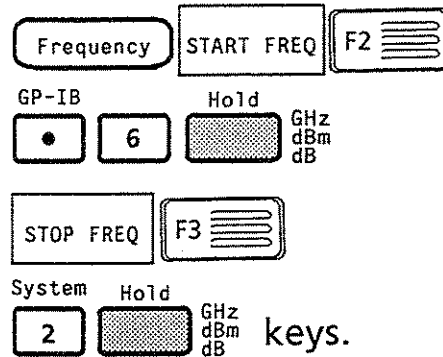

- The frequency range is set to START: 600 MHz, STOP: 2 GHz.
- The 500 MHz spectrum is off the screen.

2 Press the **Auto Tune** key.

- The frequency setting mode is set to CENTER: 500 MHz, SPAN: 100 MHz.
- CENTER is the screen center, which is determined from the peak-level spectrum frequency of the current Trace BG (0 to 8.5 GHz) with the zero-beat signal removed. Therefore, the 500 MHz spectrum is set to the center of the screen even if it is outside the displayed screen.
- At the same time, the peak-level point is set to the REF LEVEL line.

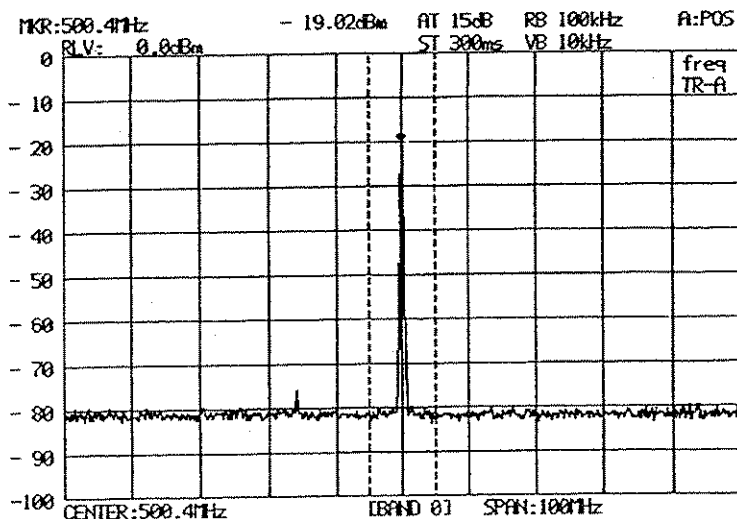

3 Press the **Amplitude** key.

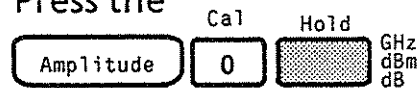

- REFERENCE LEVEL = 0.0 dBm is display at the communication field as the data entry response.
- Setting of RLV: 0 dBm and ATT .10 dBm lowers the entire sweep trace by approximately 20 dB.

1.4.3 Expanding and compressing measurement signal waveform SPAN

The object measurement signal can be set to the center frequency as described previously. The first process in the next step is to expand or compress the waveform to an easy-to-view size. To expand the waveform, the frequency span is made narrower and to compress the waveform, it is made wider.

[Span] key is used to set the frequency span by data entry, and STEP keys are used to raise / lower the frequency span in a 1-2-5 / 5-2-1 sequence.

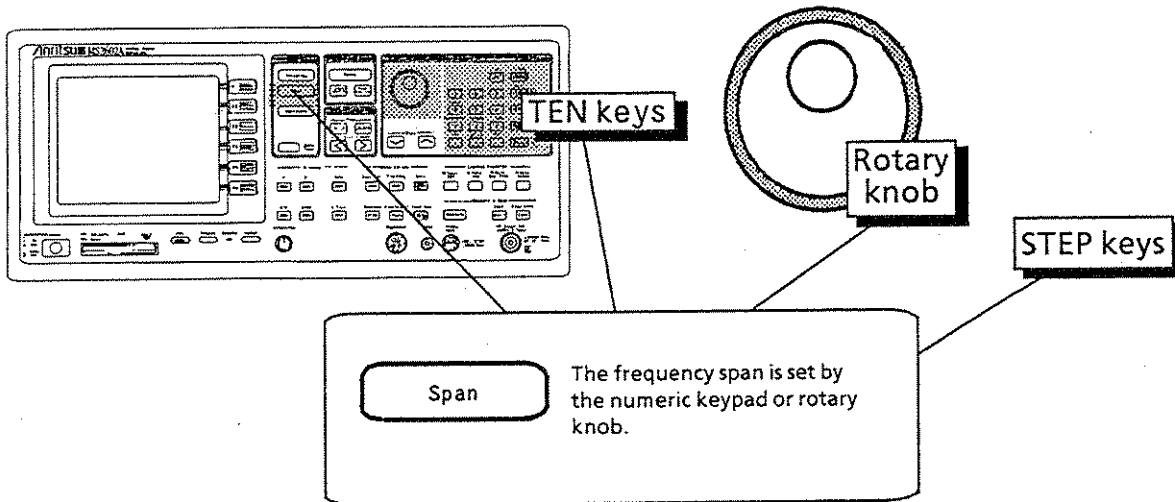

The waveform (in state of step 3 on previous page) is expanded → compressed → expanded by setting SPAN = 100 MHz → 2 kHz → 100 MHz → 2 kHz as shown below.

- 1 Press the Span key.
- 2 Press the ▼ key until SPAN 2 kHz is obtained.
- 3 Press the ▲ key until SPAN 100 MHz is obtained.
- 4 Press the 2 System kHz key.
 - The frequency span is set to 2 kHz.



1.4.4 Measuring signal level CAL, PEAK → CF / REF

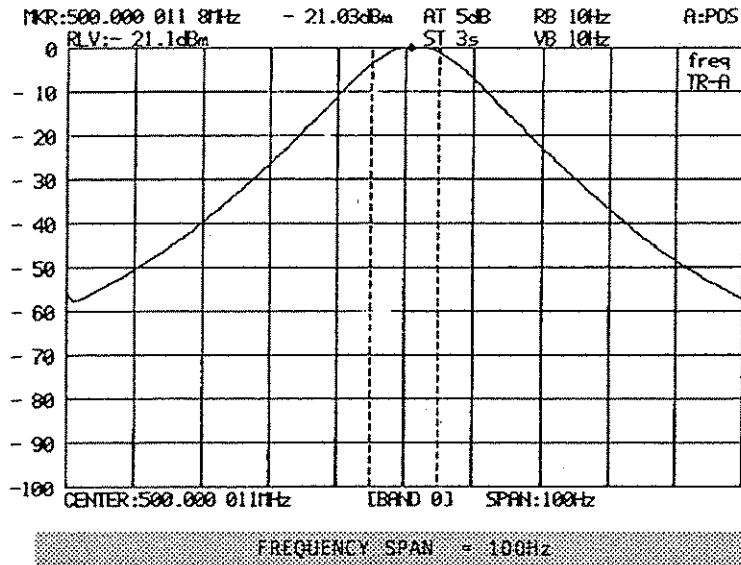

The measurement waveform so far has included amplitude error caused by RBW switching and by span switching, and LOG linearity error (step error) because the level observation point is not at the REF LEVEL line. To minimize these errors, the level is measured after all calibration has been performed.



The example below measures the peak level of the measurement signal after setting the span to the 100 Hz minimum value.

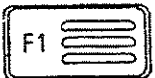

1 Press the  key until SPAN 100 Hz is obtained.

2 Press the     keys to execute all calibration on page 1-10.

3 Press the   key to set the peak level in zone marker to the center.

4 Press the   key to set the peak level at the reference level.

- The peak level at the minimum span is measured as -21.03 dBm from reading the RLV and MKR levels of the figure above.

1.5 Hard Copying Measurement Screen with Video Plotter

The measurement data and waveform data on the screen can be hard-copied to record the measured result. The MS2602A outputs the screen video signal from the rear-panel Digital RGB and Separate connectors.

To obtain a hard copy with a video plotter, connect the the rear-panel Separate output to the video plotter. (For details, refer to the Appendix C or the separate UA455A Video Plotter manual.)

Note that in addition to the UA455A, you may also use the VP-1500 II Video Printer (Seikosha Corp.). Refer to Appendix D regarding detailed information.

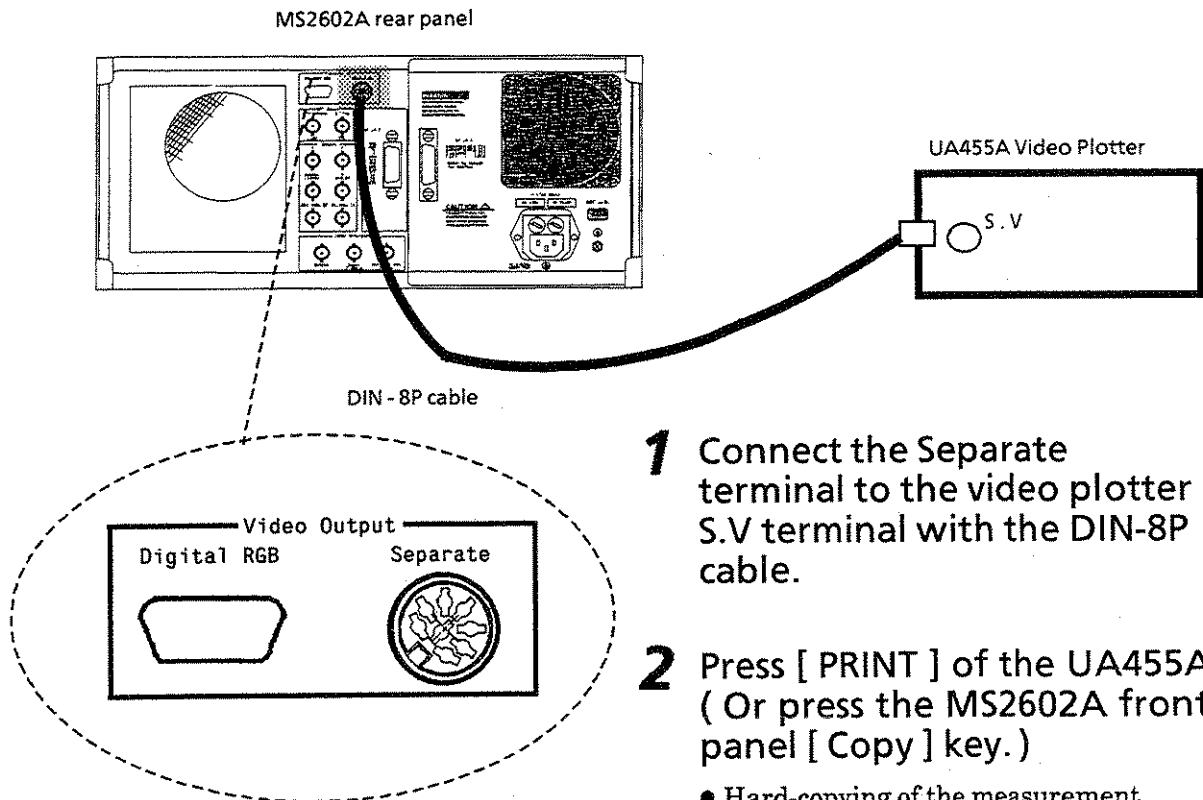

SECTION 2

FREQUENCY / AMPLITUDE DATA ENTRY

This section describes the data entry function relating to frequency and amplitude in the Freq / Ampl section on the front panel. This section also describes how to use the panel keys in other sections which are related to the Freq / Ampl section.

TABLE OF CONTENTS

2.1	Setting Observation Frequency	2-3
2.1.1	CENTER-SPAN mode	2-4
2.1.2	START-STOP mode	2-5
2.1.3	START-SPAN mode	2-6
2.1.4	Setting step size with step keys	2-7
2.1.5	Moving observation frequency with scroll keys	2-8
2.1.6	Selecting the fixed frequency band	2-10
2.1.7	Setting full span	2-11
2.1.8	Setting zero span	2-11
2.1.9	Setting the FINE ADJ	2-12
2.2	Setting Level Range	2-13
2.2.1	Setting log / linear scale	2-14
2.2.2	Selecting reference level units	2-15
2.2.3	Setting reference level	2-16
2.2.4	Setting reference level step size	2-17
2.3	Offsetting Reference Level	2-18

SECTION 2

FREQUENCY / AMPLITUDE DATA ENTRY

2.1 Setting Observation Frequency

The observation frequency of the MS2602A is set in three modes as follows:

- CENTER-SPAN
- START-STOP
- START-SPAN

The upper and lower limits of the frequency are -100 MHz and 8.5 GHz, respectively, whichever mode has been set.

The [Frequency] key is used as the header key for setting the frequency, and the [Span] key is used as the header key for setting the frequency span.

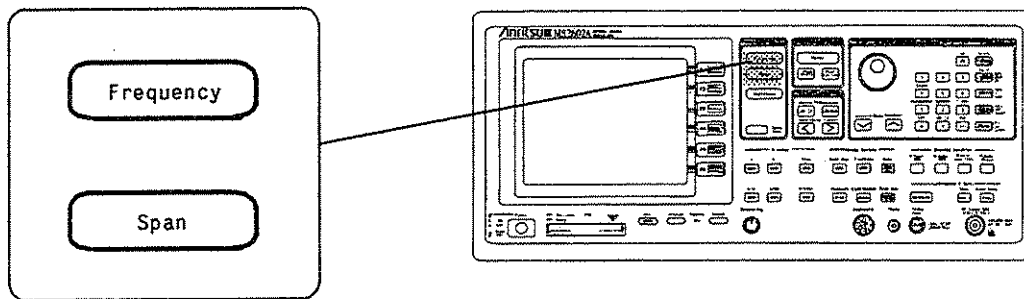

2.1.1 CENTER-SPAN mode

(1) Setting center frequency

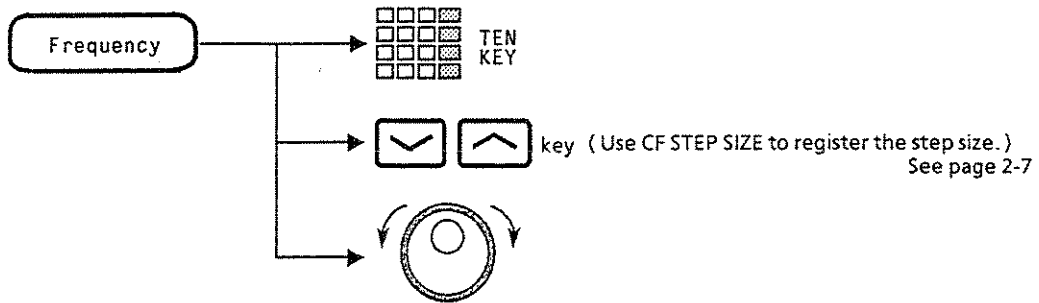

(2) Setting frequency span

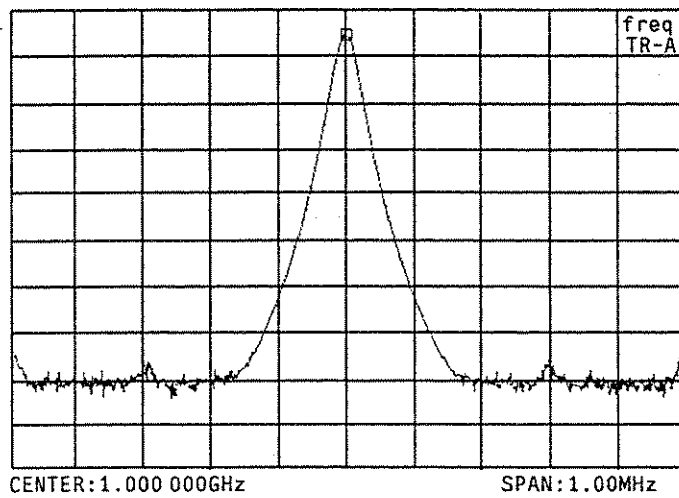
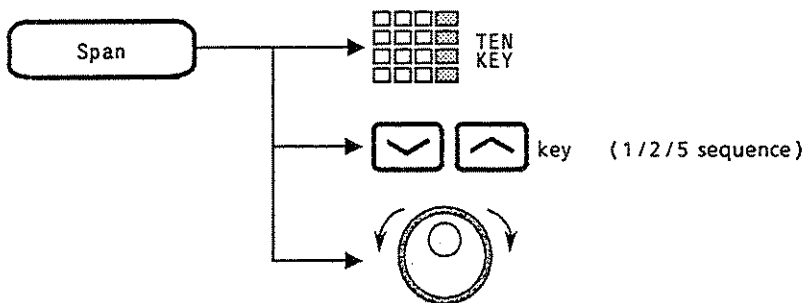

2.1.2 START-STOP mode

(1) Start frequency

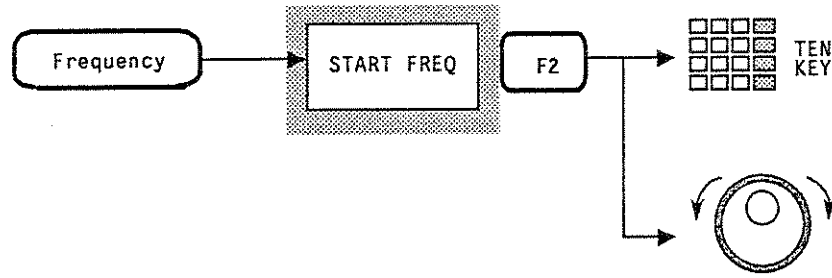

(2) Stop frequency

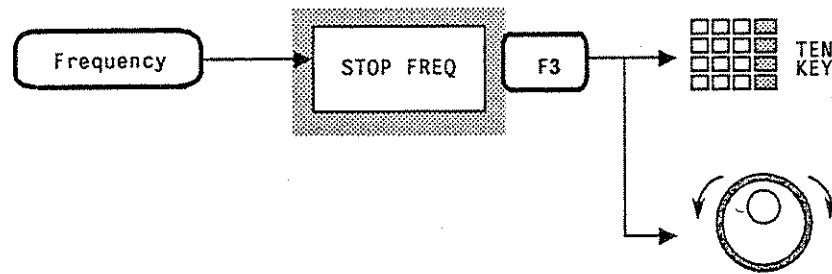

- Notes:**
- Since the [V] [^] keys are used to increase or decrease the center frequency by the step size, the start and stop frequencies are also changed.
 - The stop frequency may also vary depending on the values of the frequency span setting resolution and start frequency.

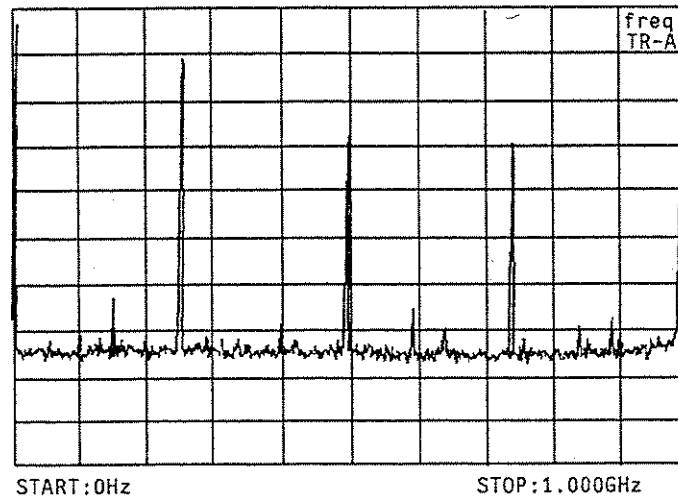

2.1.3 START-SPAN mode

(1) Start frequency

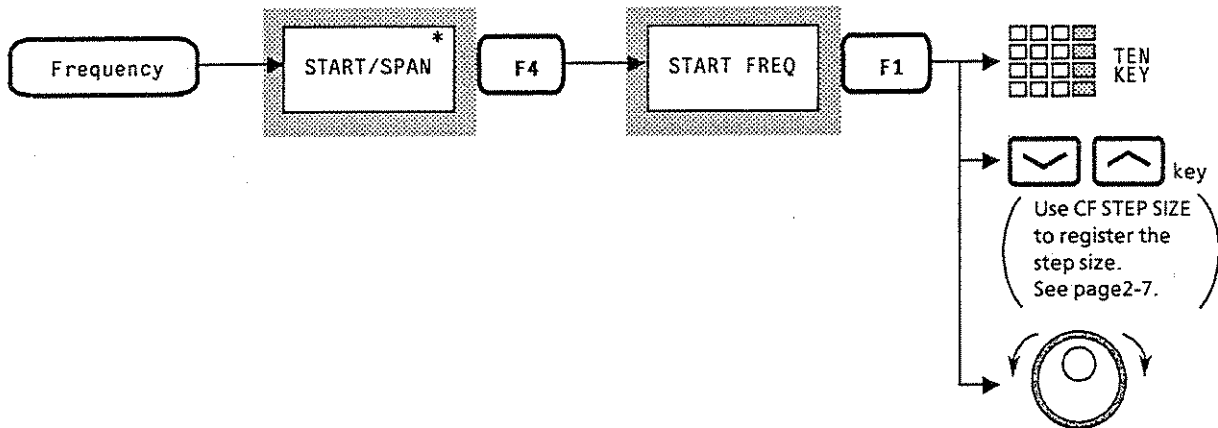

(2) Frequency span

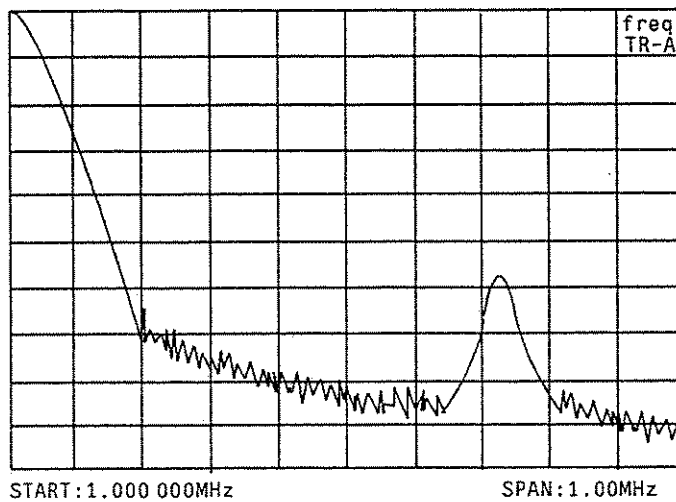
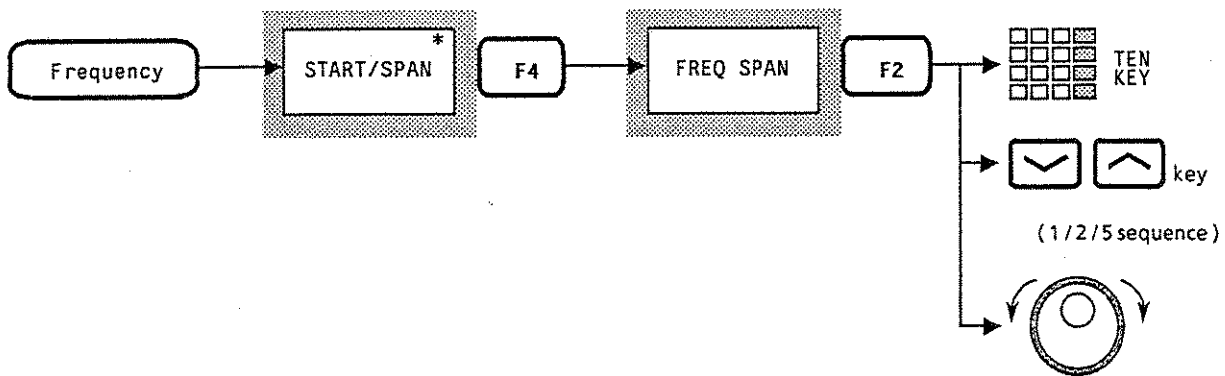

2.1.4 Setting step size with step keys

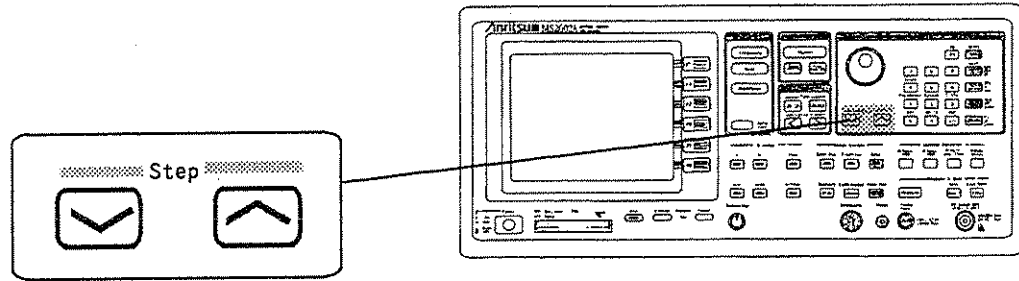

To use the [∇] [\wedge] keys to change the step size of the center frequency, use CF STEP SIZE for registration as follows, then set the specified step size with the [∇] [\wedge] keys.

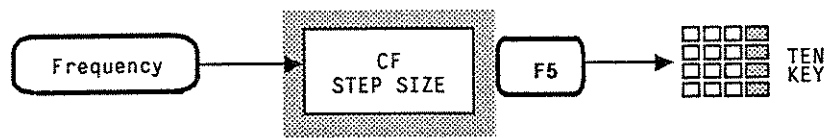

2.1.5 Moving observation frequency with scroll keys

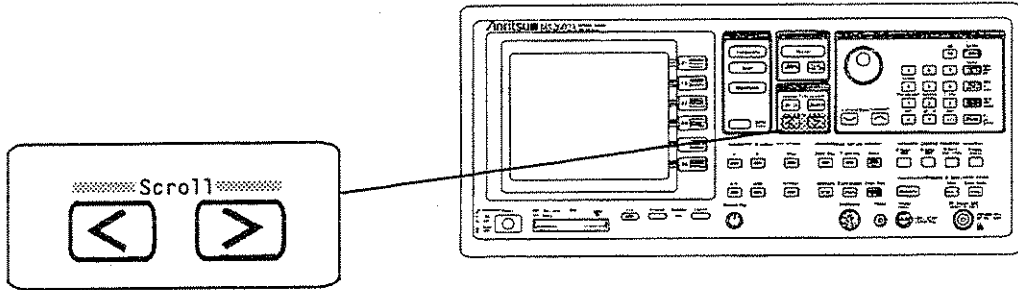

Use the [<] [>] Scroll keys on the Signal Search section to scroll an observation frequency.

The scroll step size can be registered as follows.

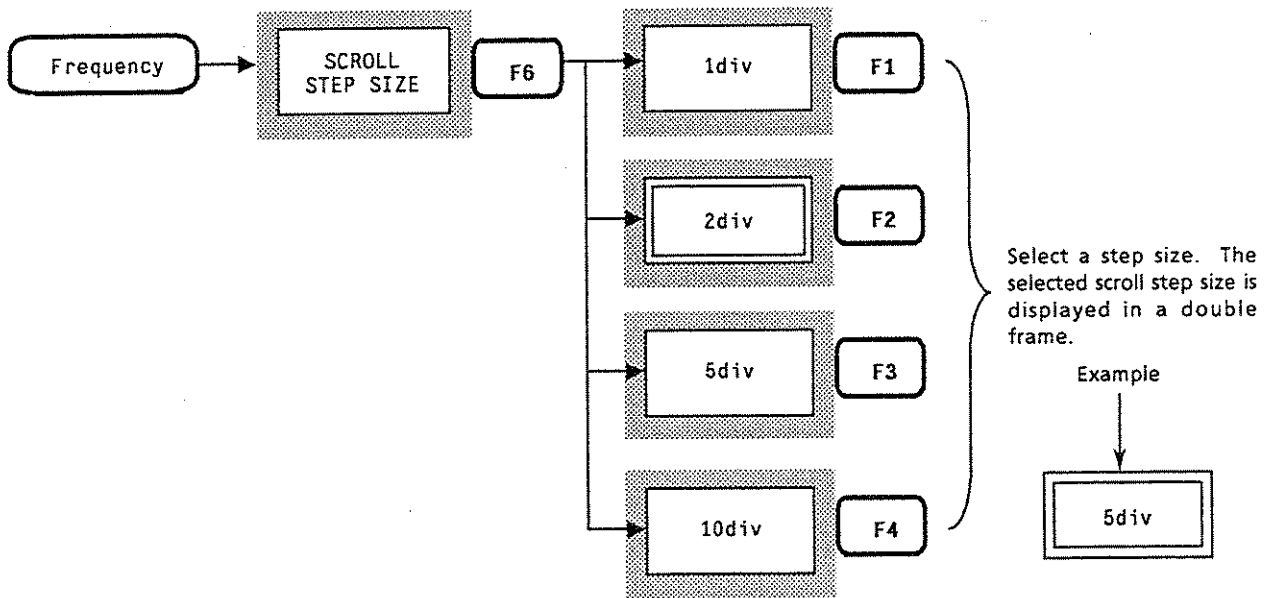

(1) Left scroll example (by 2 div)

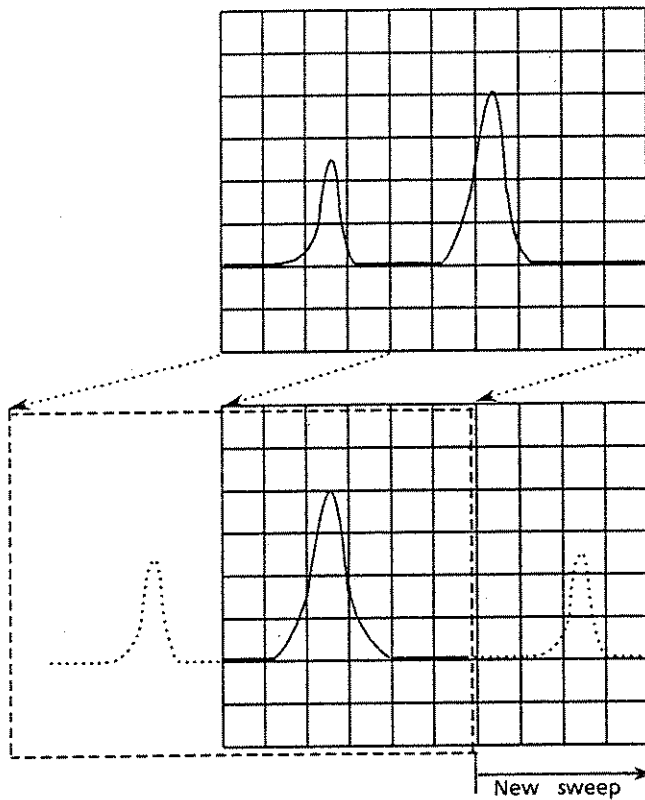

Press the [<] Key once; the spectrum waveform moves by two divisions to the left when scrolled. The sweep is then performed two divisions to the right and the new waveform is displayed on the screen.

The diagram on the left shows the result of pressing the [<] key twice sequentially.

(2) Right scroll example (by 2 div)

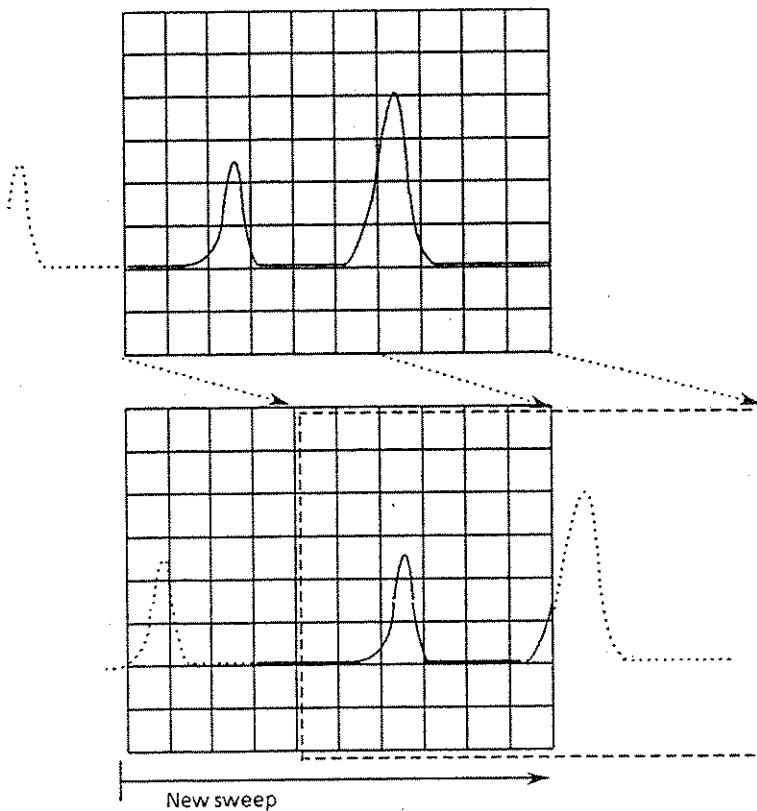

Press the [>] key once; the spectrum waveform moves two divisions to the right when scrolled, then a new sweep starts from the leftmost side.

The diagram on the left shows the result of pressing the [>] key twice sequentially.

2.1.6 Selecting the fixed frequency band

The MS2602A covers a frequency range of 0 to 8.5 GHz, in three bands as listed below:

- 0 band 0 to 2 GHz
- 1⁻ band 1.7 to 7.5GHz
- 1⁺ band 6.5 to 8.5GHz

The MS2602A initially operates in AUTO BAND mode, and selects the most appropriate band automatically according to the observation frequency range.

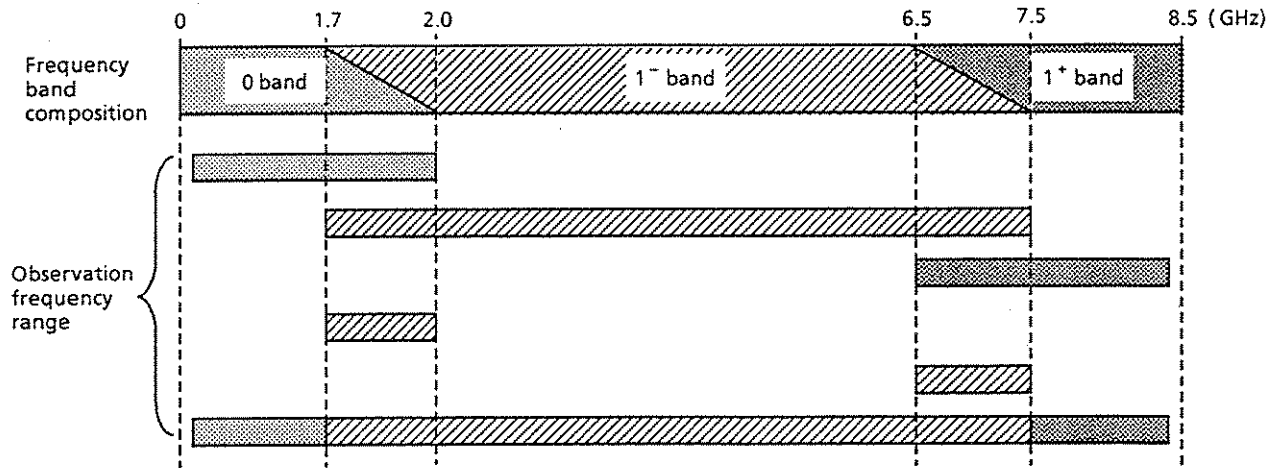

Frequency Band Selection Based on Observation Frequency in AUTO BAND Mode

To obtain the fixed frequency band without switching the contiguous frequency band, perform the following key operations.

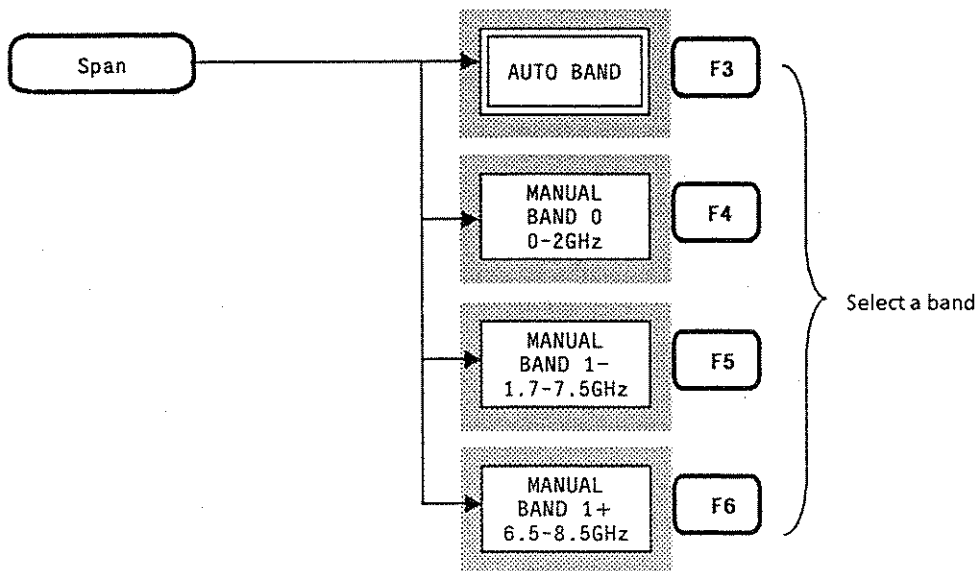

Frequency band selection results in the full span covering the range of the frequency band.

2.1.7 Setting full span

In the normal operating state, pressing the [Preset] key allows the entire frequency range (0 to 8.5 GHz) of the MS2602A to be swept in a full span. However, this setting also initializes the parameters except the frequency range.

To set the full span and leave other parameters unchanged, perform the following key operations.

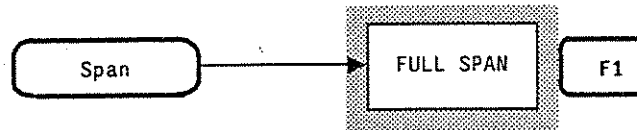

Note: When the fixed frequency band has been set as explained above, only the full span covering the range of the frequency band is set.

2.1.8 Setting zero span

The MS2602A Spectrum Analyzer can operate as a selective level meter in which the horizontal axis is graduated as a time axis by setting the frequency span to 0 Hz.

Performing any of the following key operations allows the MS2602A to operate in zero span (time domain) mode.

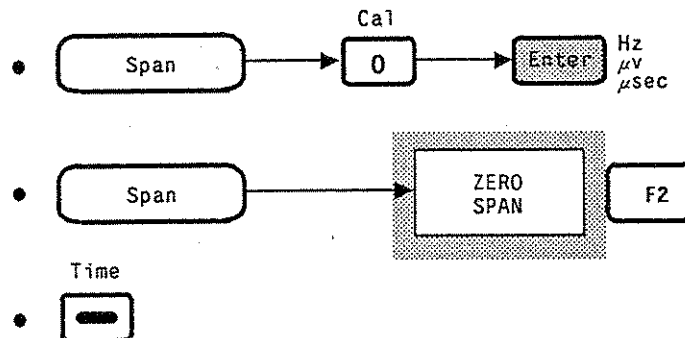

For further details on zero span (time domain) see SECTION 5, SELECTING DISPLAY METHODS (page 5-21).

2.1.9 Setting the FINE ADJ

The displayed frequency of this Spectrum Analyzer includes an error in the accuracy range [\pm (displayed frequency \times accuracy of standard frequency + span frequency \times span accuracy)]. If this error becomes significant, the FINE ADJ function can be used to adjust the internal setting frequency without changing the displayed frequency.

The relationship between the FINE ADJ frequency and the setting frequency is as follows:

- The relationship between frequencies when FINE ADJ is ON:
input frequency = displayed frequency
internal setting frequency = input frequency + FREQ CAL – FINE ADJ frequency
- The relationship between frequencies when FINE ADJ is OFF:
input frequency = displayed frequency
internal setting frequency = input frequency + FREQ CAL

FREQ CAL is an internal correction value that is obtained at the time of automatic calibration (refer to Chapter 8). When the FINE ADJ function is ON, the mark “ * ” is indicated at the end of the frequency value on the bottom line of the screen as follows.

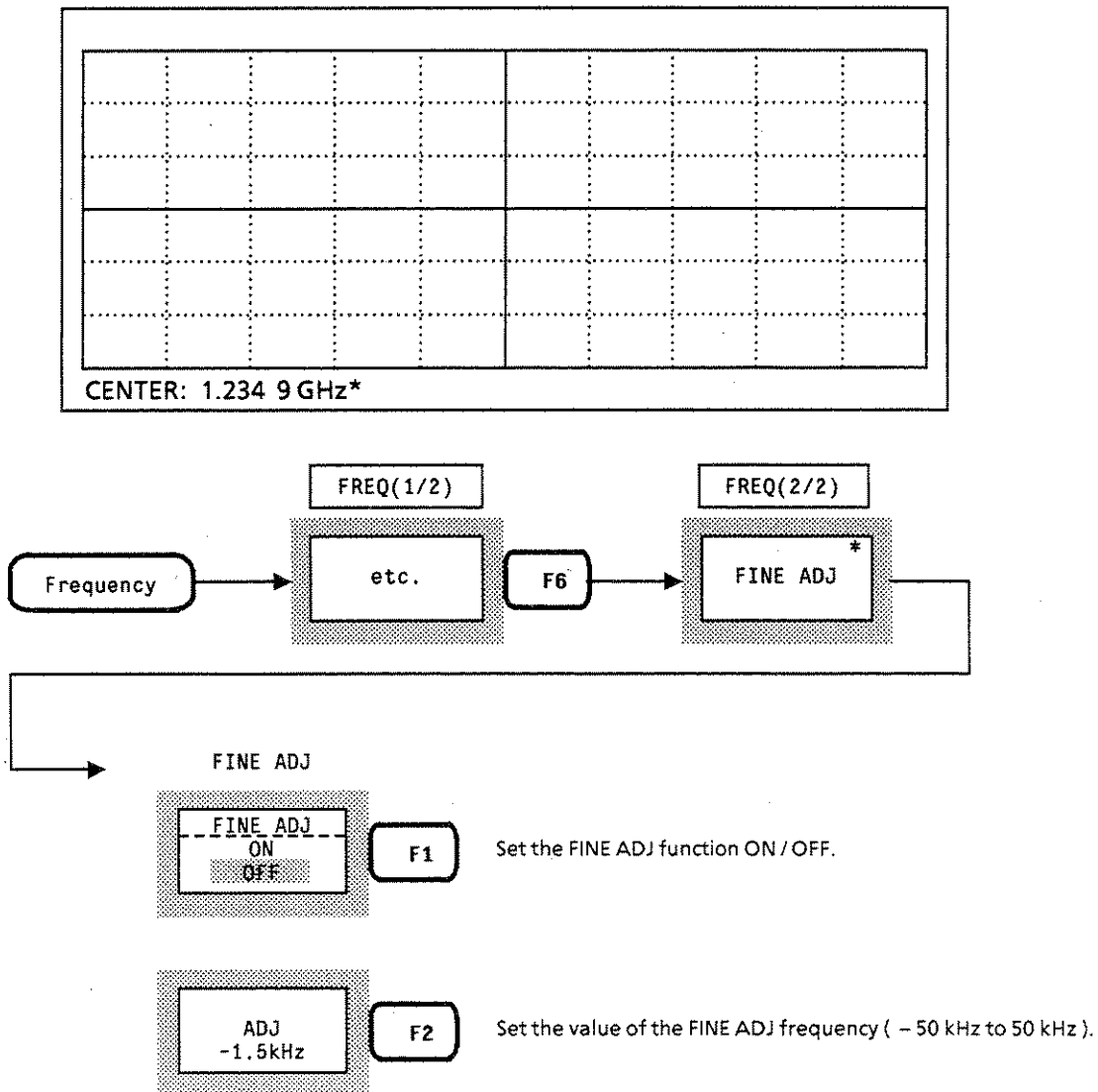

2.2 Setting Level Range

The table below shows the types of MS2602A level display modes and the ranges of the reference level (top graticule of the amplitude scale) for the different modes.

Display mode	Units	Reference level range
Log scale	dBm	-100 to +30 dBm
	dB μ V	+7 to +137 dB μ V
	dBmV	-53 to +77 dBmV
	V	2.2 μ V to 7.07 V
	dB μ V (emf)	+13 to +143 dB μ V (emf)
	W	100 fW to 1.00 W
Linear scale	V	22.3 μ V to 7.07 V

dBm: dBm unit system where 1 mW / 50 Ω is defined as 0 dBm.

dB μ V: dB μ V unit system where 1 μ V is defined as 0 dB μ V, where the terminated voltage display terminated with 50 Ω .

dBmV: dBmV unit system where 1 mV is defined as 0 dBmV, where the terminated voltage display terminated with 50 Ω .

dB μ V (emf): dB μ V (emf) unit system based on the open-voltage display, where (dB μ V + 6 dB) is fed as the output value.

The [Amplitude] key is used as the header key for setting the amplitude level.

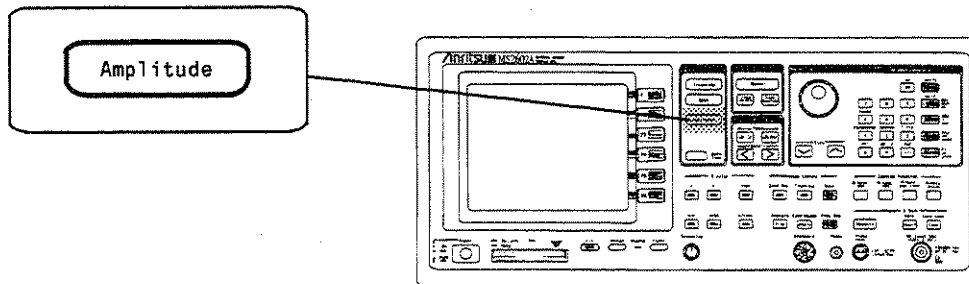

2.2.1 Setting log / linear scale

The MS2602A has an amplitude scale graduated as a log scale or as a linear scale.

(1) Setting log scale

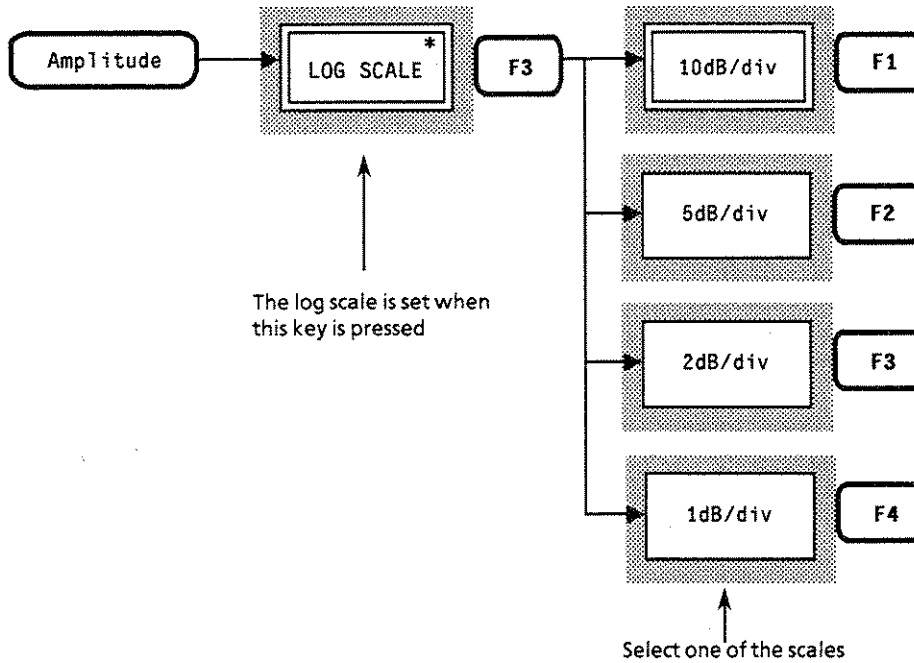

(2) Setting linear scale

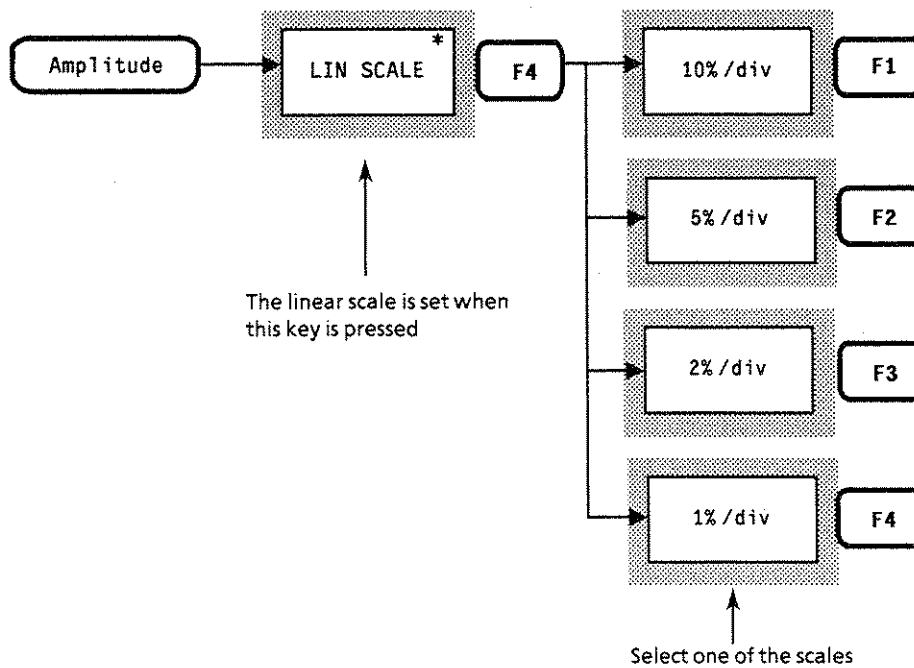

The reference level is kept constant, independent of switching between log and linear scales.

When the reference level is set to less than -80 dBm during log scale, it is impossible to switch to the linear scale.

2.2.2 Selecting reference level units

In log scale mode, the MS2602A provides six types of reference level units: dBm, dB μ V, dBmV, V, dB μ V (emf), and W. Select one of the reference level units as follows.

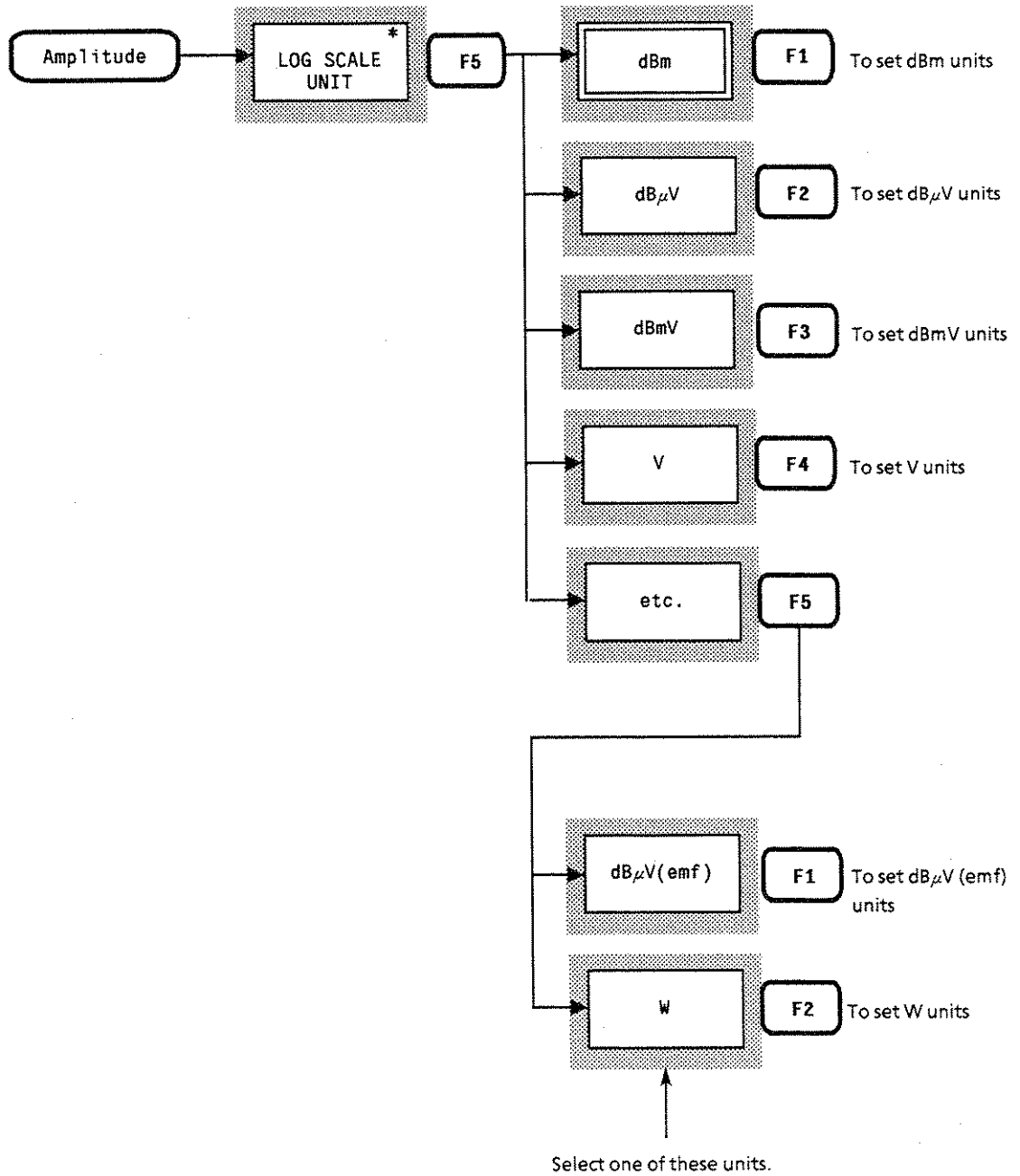

Since the reference level unit used for the linear scale is only V, there is nothing to select.

The reference level value is kept constant, independent of switching the unit of the reference level.

2.2.3 Setting reference level

Select the reference level (top graticule of the amplitude scale) as follows.

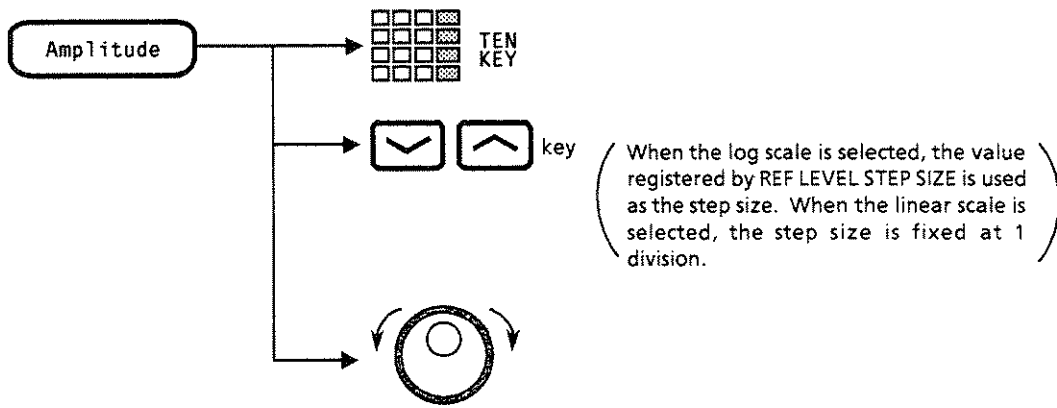

The unit key should be used as in figure according to the unit of the reference level which has been set.

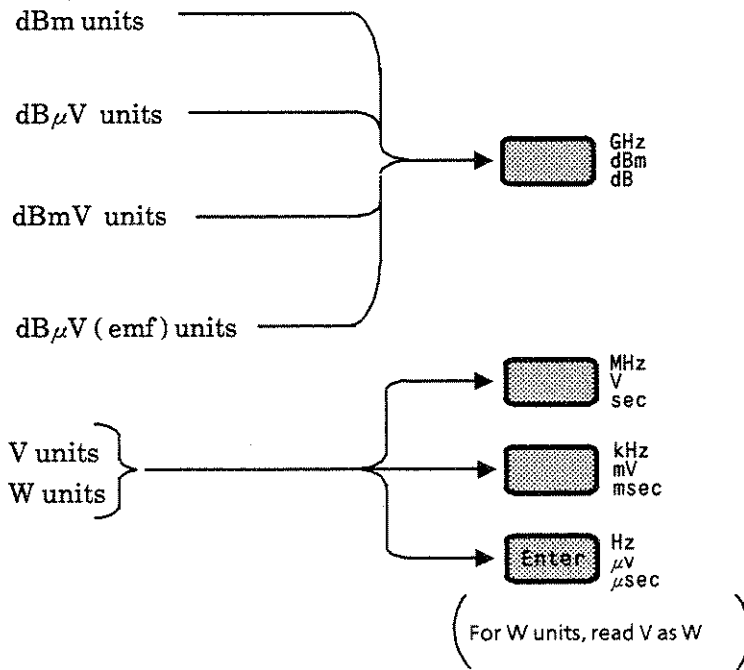

2.2.4 Setting reference level step size

To use the [∇][^] keys to change the step size of the reference level, use REF LEVEL STEP SIZE for registration as follows, then set the specified step size with the [∇][^] keys.

(1) When log scale is selected

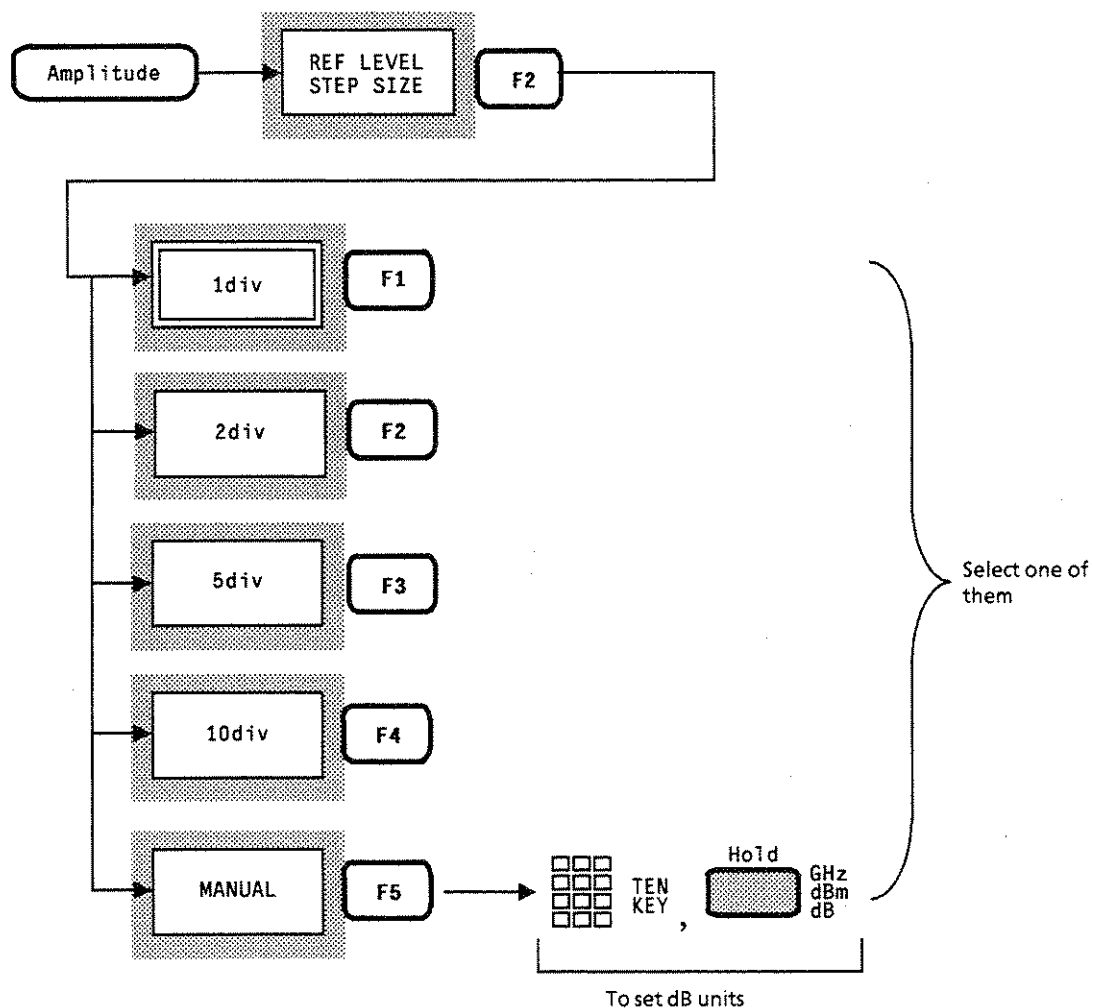

(2) When linear scale is selected

Fixed at 1 division.

2.3 Offsetting Reference Level

The reference level can be redisplayed by adding a given offset value while the position of the wave trace is unchanged.

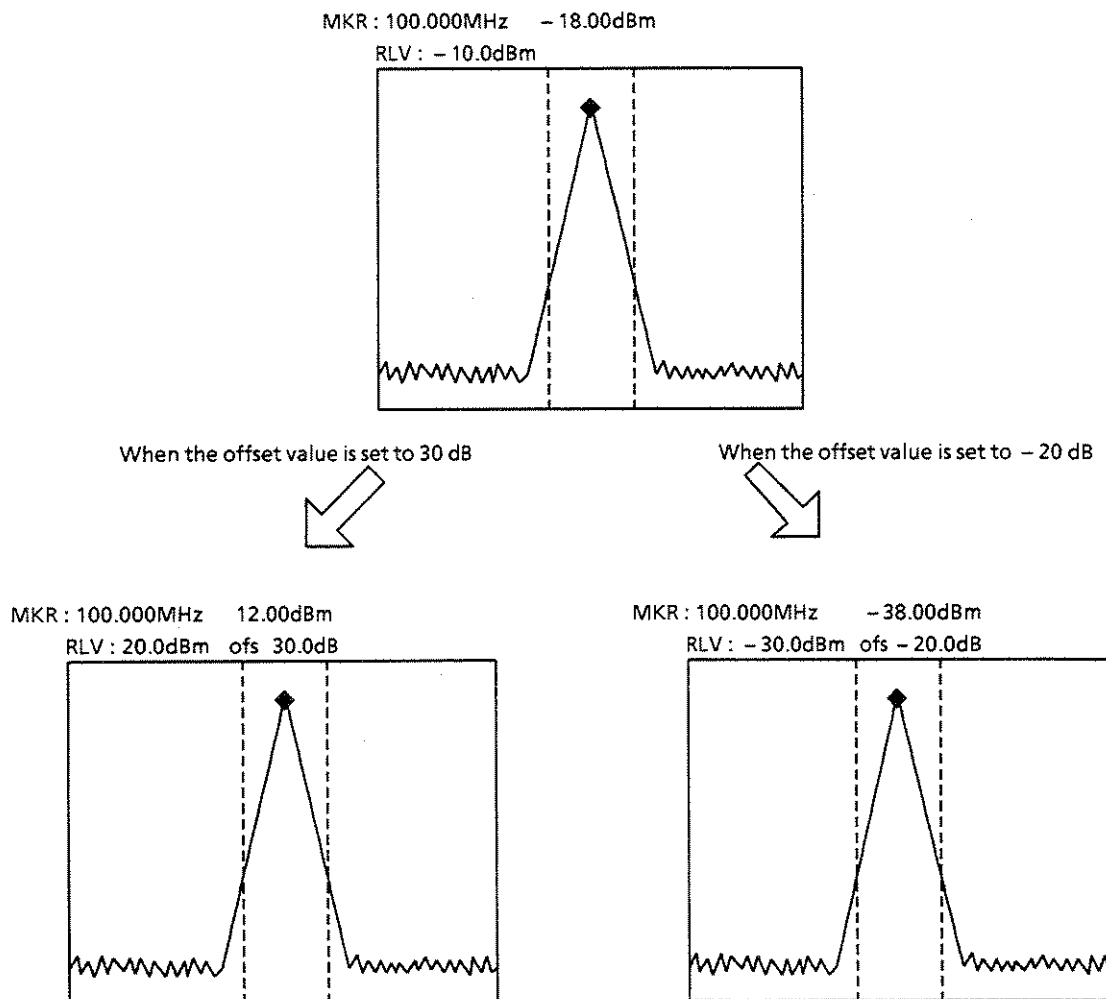

The currently indicated offset value is displayed to the right of the reference level in the upper left-hand corner of the scale.

Turn the offset display ON / OFF and set its offset value as follows:

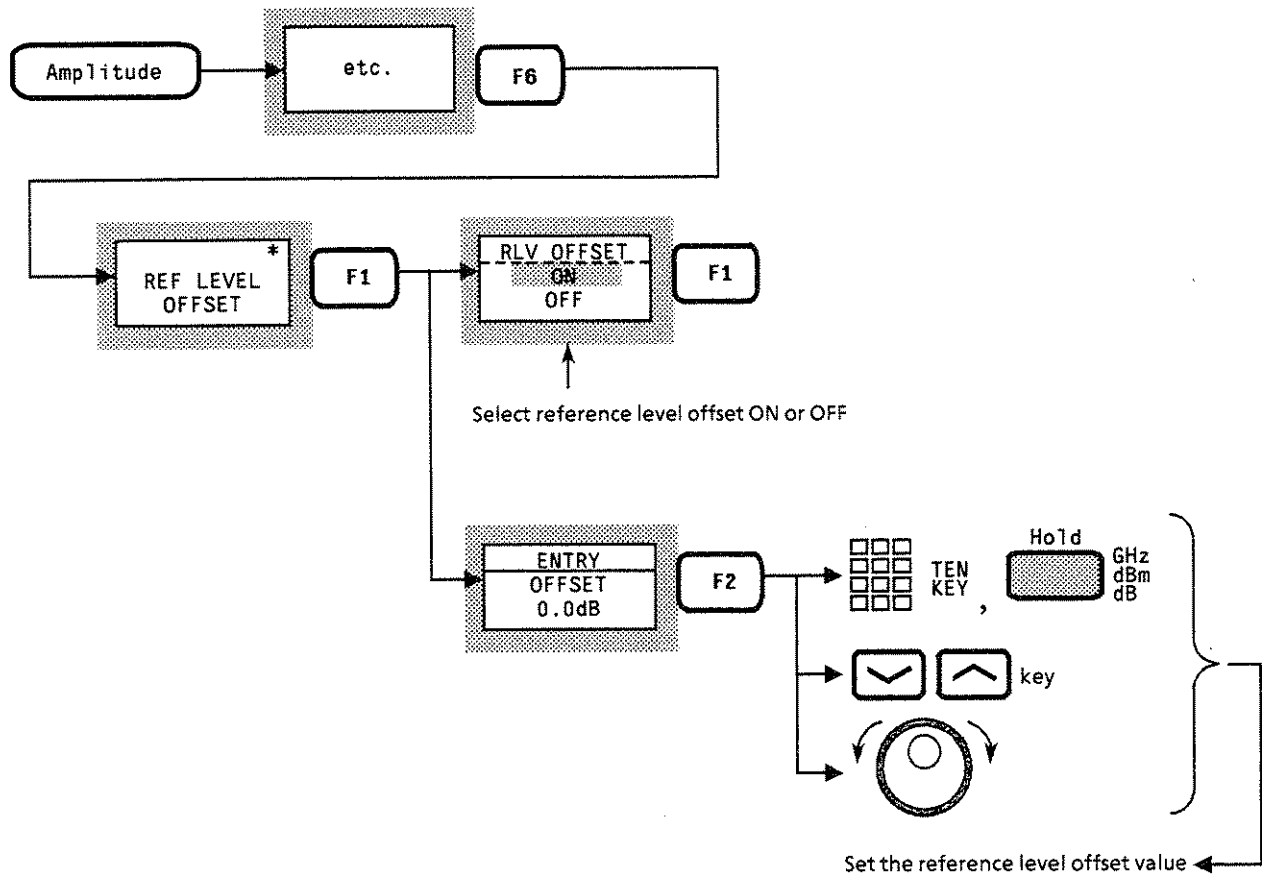

The offset value setting range is from -100 to $+100$ dB. However it is impossible to set such an offset value if the reference level is not between -100 and $+50$ dBm when offset. The offset value resolution is 0.1 dB.

The offset can be applied to each trace (A, B, BG, TIME) but it cannot be applied when monitoring FM demodulation waveforms or an external trigger signal.

SECTION 3

MARKER FUNCTION

This section describes the marker functions for improving the measurement efficiency, such as the zone marker, marker mode menu, marker search, and the parameter set with marker value.

TABLE OF CONTENTS

3.1	Changing Zone Marker Position and Width	3-3
	3.1.1 Changing zone marker width	3-4
	3.1.2 Changing zone marker position	3-6
3.2	Marker Mode	3-7
	3.2.1 Current marker	3-7
	3.2.2 Delta marker	3-8
	3.2.3 Multimarker	3-9
	3.2.4 Marker OFF	3-12
3.3	Marker Search	3-13
	3.3.1 PEAK search	3-13
	3.3.2 NEXT PEAK search	3-14
	3.3.3 MIN DIP search	3-15
	3.3.4 NEXT DIP search	3-16
	3.3.5 NEXT RIGHT PEAK search / NEXT LEFT PEAK search	3-17
3.4	Setting Parameters Using Marker Values	3-18
	3.4.1 MKR → CF / MKR → REF	3-19
	3.4.2 MKR → CF STEP SIZE	3-20
	3.4.3 ΔMKR → SPAN	3-21
	3.4.4 ZONE → SPAN	3-22
3.5	Display Line	3-23
	3.5.1 Setting the display line	3-23
	3.5.2 Displaying the marker level from the reference position of the display line	3-24

SECTION 3 MARKER FUNCTION

The keys in the Marker section are used as the header keys for setting marker functions.

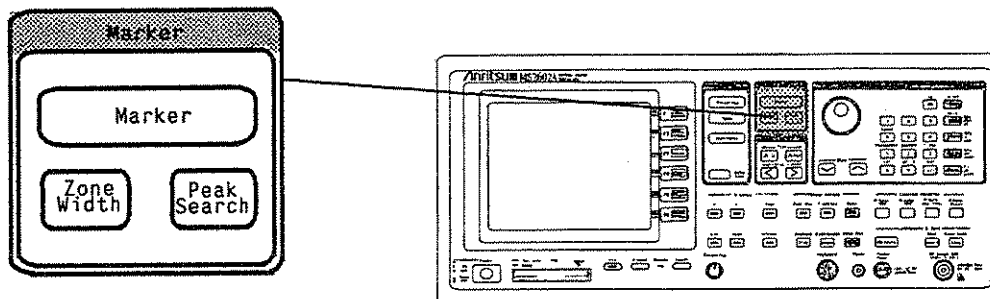

3.1 Changing Zone Marker Position and Width

The zone enclosed by dotted lines in the center of the screen shown in the diagram below is called the zone marker. The current marker within this zone marker always moves to the maximum level. The frequency (or time for time domain mode) and level at the current marker point (intensified point) are displayed at the top left-hand corner of the screen.

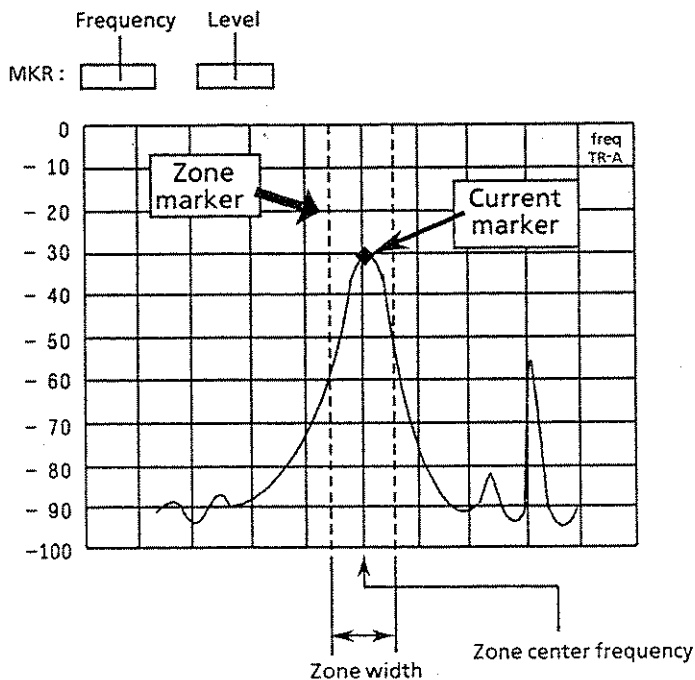

3.1.1 Changing zone marker width

The zone marker width is initially set to 1 division, which can be changed from 1 point to 10 divisions using the following key operations.

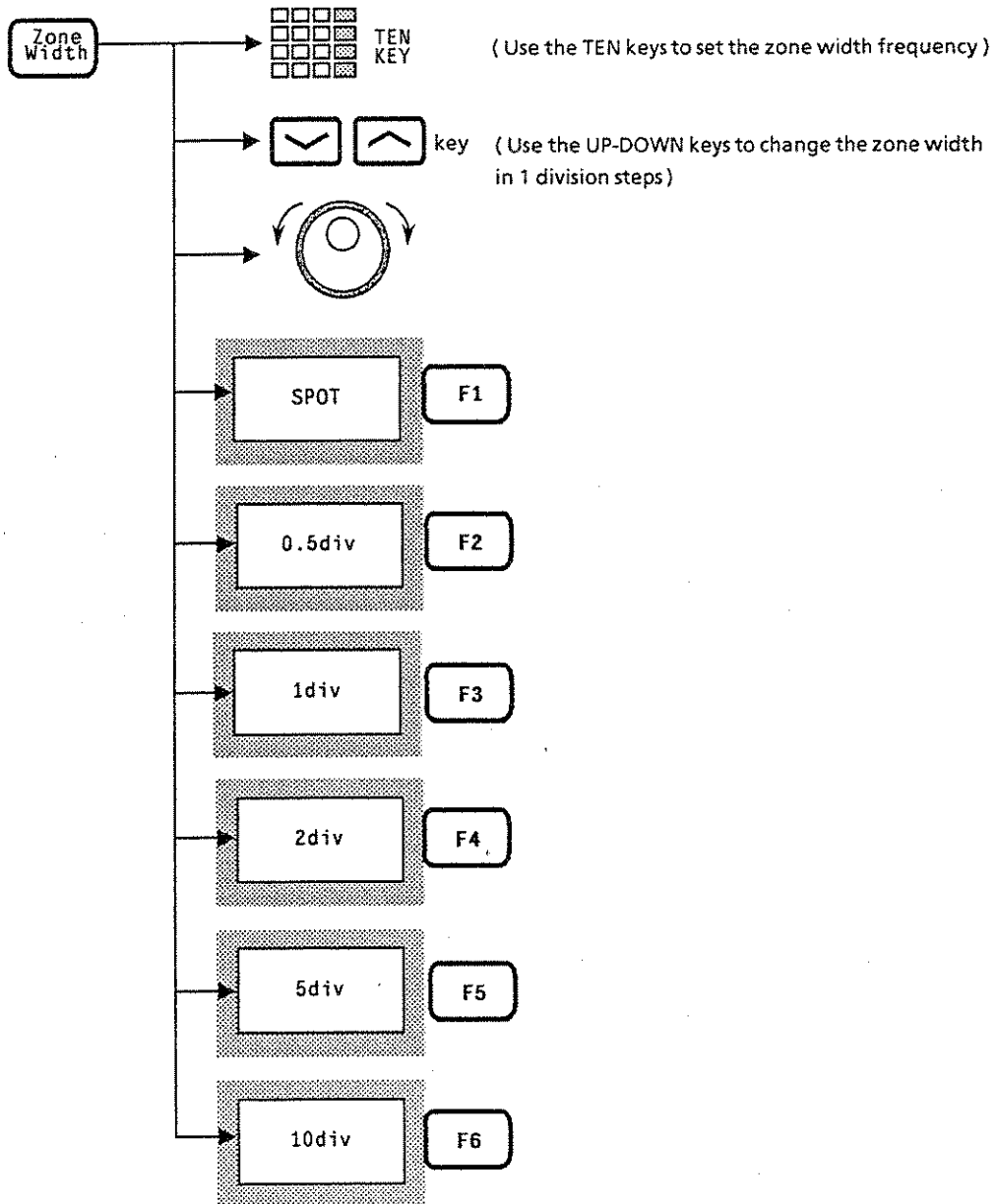

With the zone marker width set to 1 point (SPOT), the zone marker becomes just one vertical line. This is called a spot marker whose center frequency accurately coincides with the normal frequency. This spot marker allows the level to be measured at the desired frequency as required.

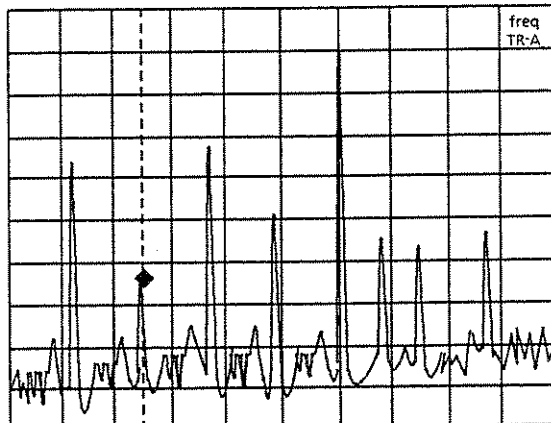

Example of Spot Marker (zone width: 1 point)

If the zone marker is set to 10 divisions when the zone center frequency is centered on the frequency axis on the screen, then the current marker always moves to the maximum peak level over the entire range of the observation frequency.

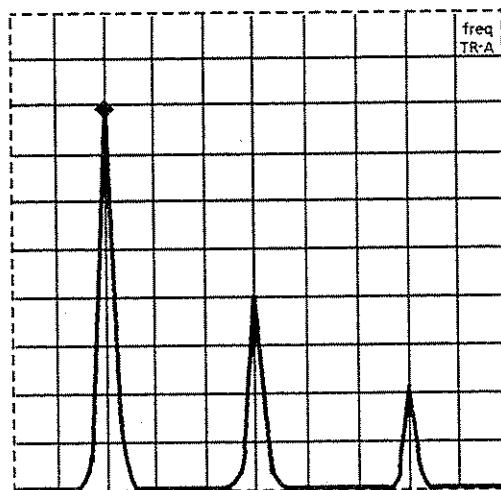

Example of Zone Width: 10 division

Since the zone width during time domain always becomes 1 point (SPOT), it is impossible to change the zone width.

3.1.2 Changing zone marker position

The center frequency (time) of the zone marker is initially centered on the frequency (time) axis on the screen. By performing the following key operations, the zone marker can be moved from the extreme left to the extreme right of the frequency axis (time) on the screen.

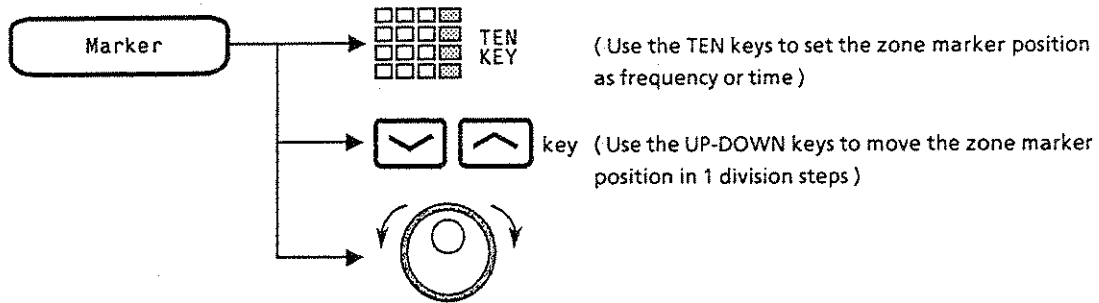

In delta marker mode, setting the zone marker center frequency (time) with the TEN keys results in entry of the delta marker value (one difference between reference marker and current marker).

3.2 Marker Mode

Three types of markers can be used with the MS2602A: current marker, delta marker, and multimarker.

3.2.1 Current marker

A single marker marked with \blacklozenge is positioned at the maximum level within the zone marker, and the frequency and level at that point are displayed digitally.

The current marker is initially set to ON for display. When the current state is in other marker mode or when the current marker is set to OFF, perform the following key operations to set the current marker to ON.

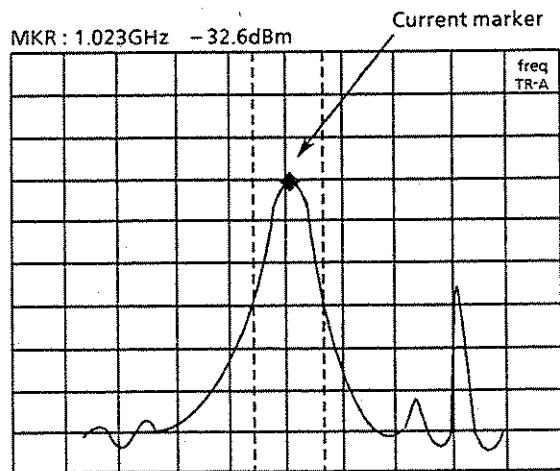
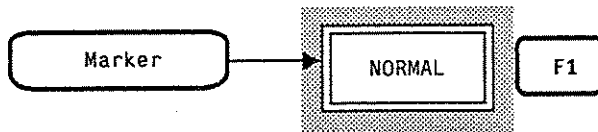

The normal marker usually displays the absolute level for reading. By setting a display line, the normal marker can also display the level relative to a given level specified as a reference line. For further details, see P3-24.

3.2.2 Delta marker

The current marker position when the delta marker is set to ON is fixed as the reference marker (reference point). Then, as the current marker is moved, one frequency (time) and one level differences between the reference marker and the current marker are displayed digitally as delta marker values.

In delta marker mode, the marker marked with \square is displayed as the reference marker.

To set the delta marker to ON, perform the following key operations.

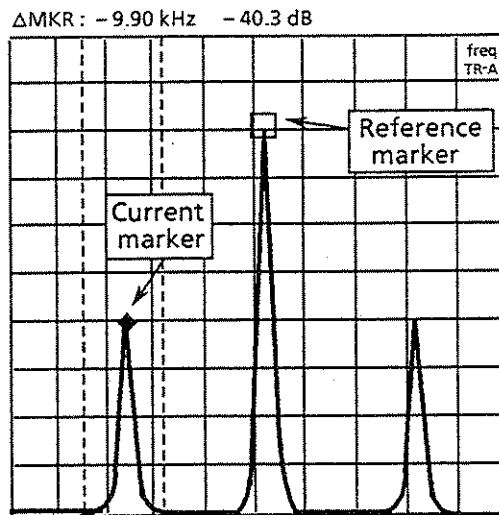
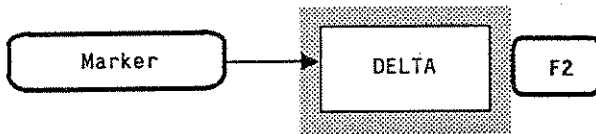

Press the [F2] (DELTA) key during delta marker mode, and the reference marker moves to the current marker position which becomes the new reference point. The delta marker mode allows that point to be used as the new reference point.

The reference marker frequency and level in delta marker mode do not change by varying the spectrum waveform. The reference marker is not necessarily always on the waveform because it remains unchanged. Also, when the reference marker cannot be positioned on the screen by changing the observation frequency and level range, it is displayed at the edge of the scale lines.

The marker mode at delta marker-ON becomes normal mode when the scale mode is changed from log scale to linear scale and vice-versa. If the scale mode is changed, set the new delta marker again.

3.2.3 Multimarker

The MS2602A provides a marker function with which up to ten markers can be displayed simultaneously. There are three methods of multimarker setting as follows:

- HIGHEST 10
- HARMONICS
- MANUAL SET

(1) HIGHEST 10

Allocates up to ten multimarkers in descending order of signal peak level displayed on the screen.

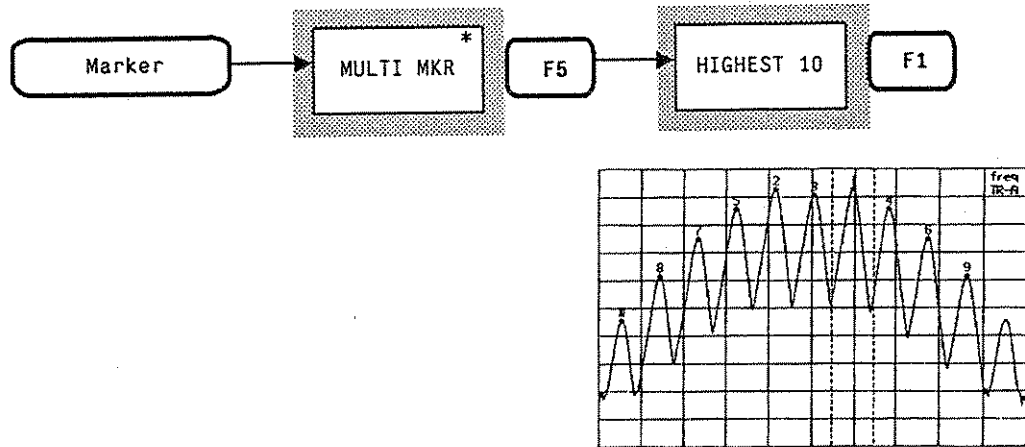

After executing HIGHEST 10, an active marker (with the same functions as current marker) moves to the peak point of the maximum level signal.

(2) HARMONICS

Allocates multimarkers to the harmonic signals associated with the maximum level signal existing within the zone marker.

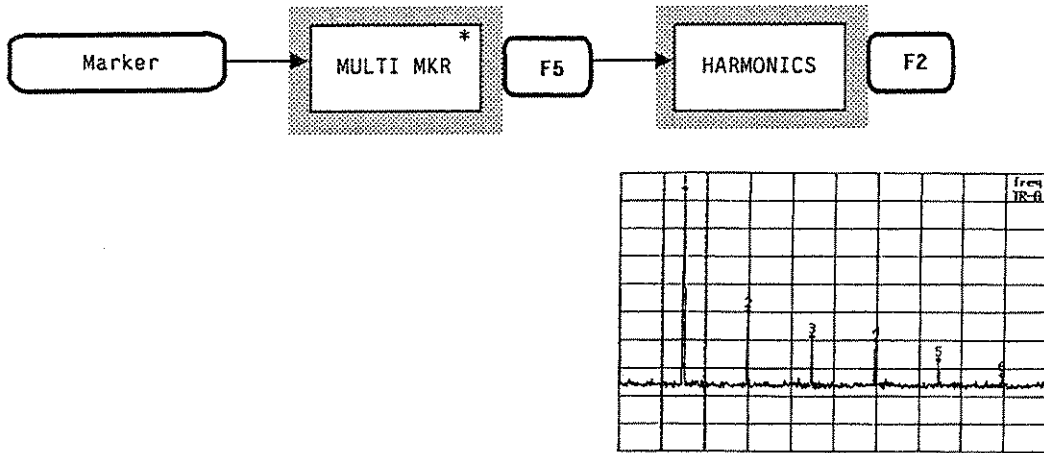

When there is a distance of less than 1 division between fundamental and second harmonic signals or when larger signals except harmonic signals are located in the frequency range of 1 division where there are mainly harmonic frequency signals, harmonic signals are incorrectly detected.

(3) MANUAL SET

Allocates up to ten multimarkers to arbitrary frequencies or time points.

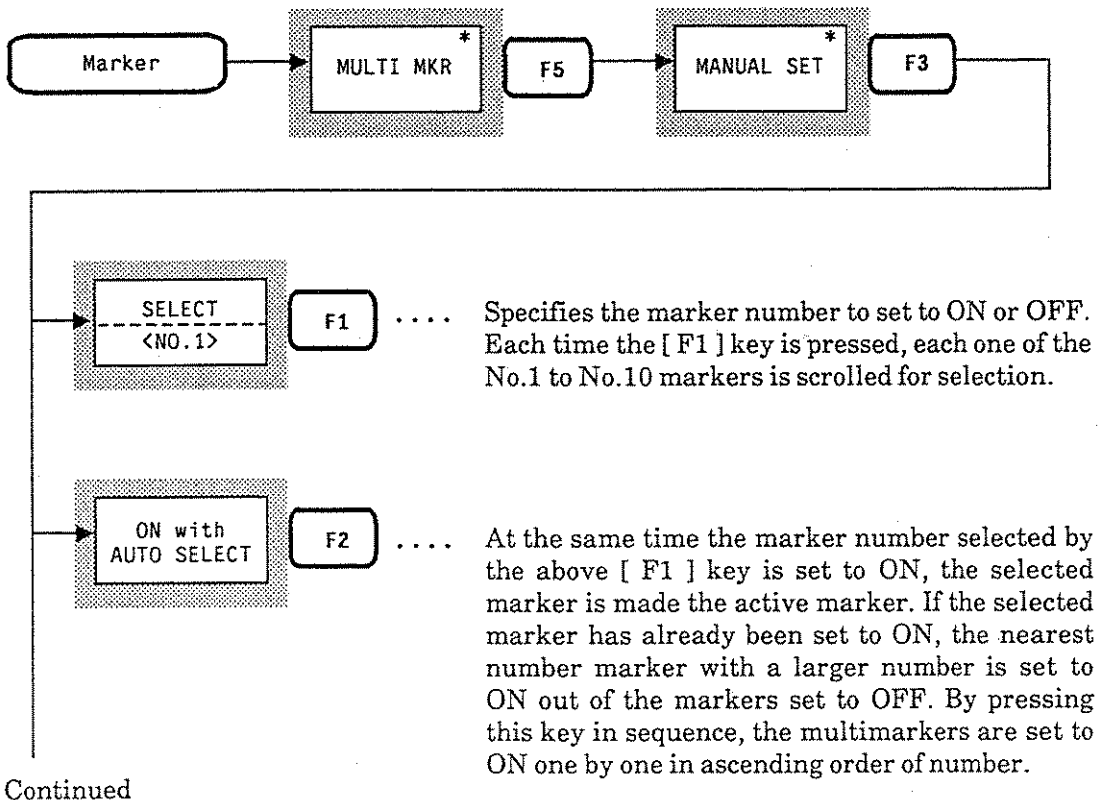

< Example > When marker No.4 is selected to set to ON with marker Nos.3, 4, 5, 8, and 9 set to ON, the rest of the markers are set to ON in order of No.6, 7, 10, 1, 2.



..... The marker number selected by the preceding page [F1] key is set to OFF. If the selected marker has already been set to OFF, the nearest number marker with a smaller number is set to OFF out of the markers set to ON. By pressing this key in sequence, the multimarker is set to OFF one by one in descending order of number. when the active marker is set to OFF, the marker with the next smaller numbers is made the active marker.

< Example > When marker No.7 is selected to set to OFF with marker Nos. 3, 4, 5, 8, and 9 set to ON and markers No.5 made active, the marker is set to OFF in order of No.5, 4, 3, and 9, then marker No.8 remaining becomes the active marker.



..... Selects an active marker out of the markers currently set to ON. Each time this key is pressed, the marker number set to ON out of markers No.1 to No.10 is scrolled for selection. The active marker is displayed with \blacklozenge and other markers are displayed with \blacklozenge . The active marker always displays the peak level point within the zone marker just as the current marker. It can also be moved with the TEN keys, [∇] [\wedge] keys, or rotary knob.

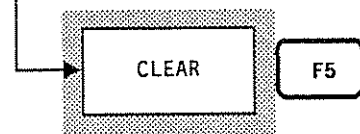

..... Leaves only the marker number currently made the active marker and sets all other multimarkers to OFF. The active marker number is then reset to 1.

To set a multimarker to ON/OFF, perform the following key operations.

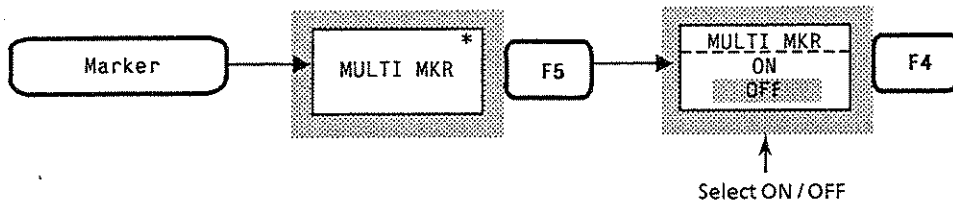

The following operations can also display the marker list from which all marker values can be read. (When a multimarker is set to ON, the marker list is displayed automatically.)

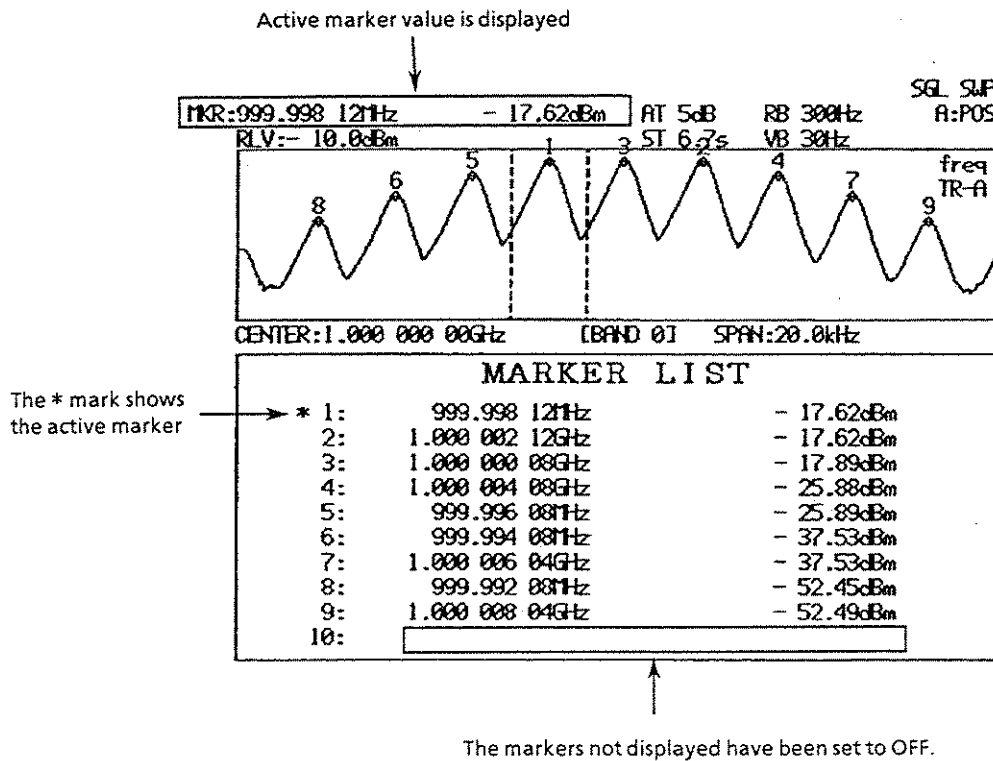
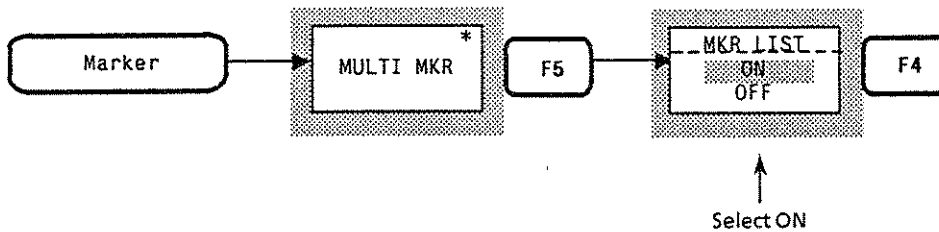

3.2.4 Marker OFF

To set all multimarkers to OFF, perform the following key operations.

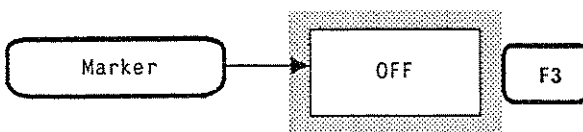

3.3 Marker Search

The MS2602A provides six types of marker search functions as follows:

- PEAK search
- NEXT PEAK search
- MIN DIP search
- NEXT DIP search
- NEXT RIGHT PEAK search
- NEXT LEFT PEAK search

3.3.1 PEAK search

From the entire trace in which a marker is displayed, the maximum level point is detected and the marker is moved to that point.

Execute the PEAK search by using the following key operations.

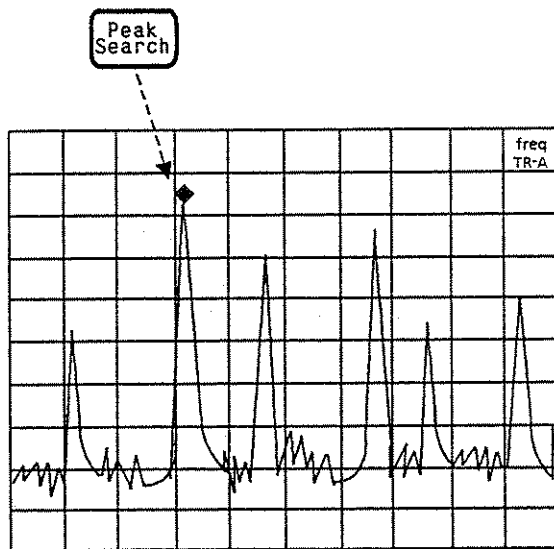

3.3.2 NEXT PEAK search

The next largest peak relative to the current marker level is detected and the marker is moved to that point. (When there are two or more peaks with the same level on the screen, the leftmost peak is detected.)

Execute the NEXT PEAK search by using the following key operations.

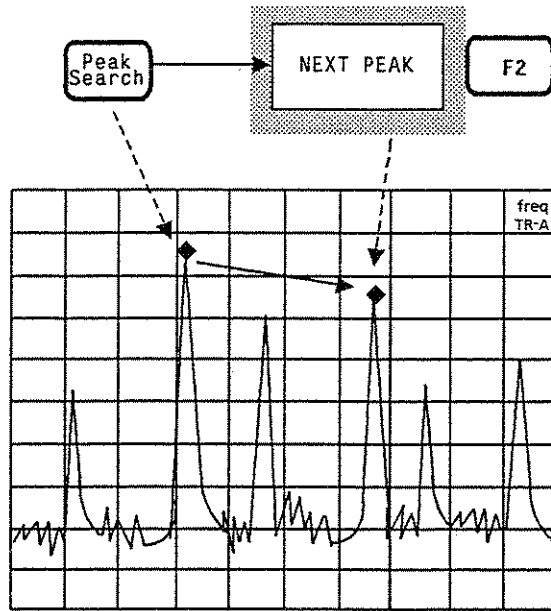

The consecutive NEXT PEAK search execution allows the next largest peaks to be detected one after another for marker movement to the detected point.

3.3.3 MIN DIP search

From the entire trace in which a marker is displayed, the minimum level point is detected and the marker is moved to that point.

Execute the MIN DIP search by using the following key operations.

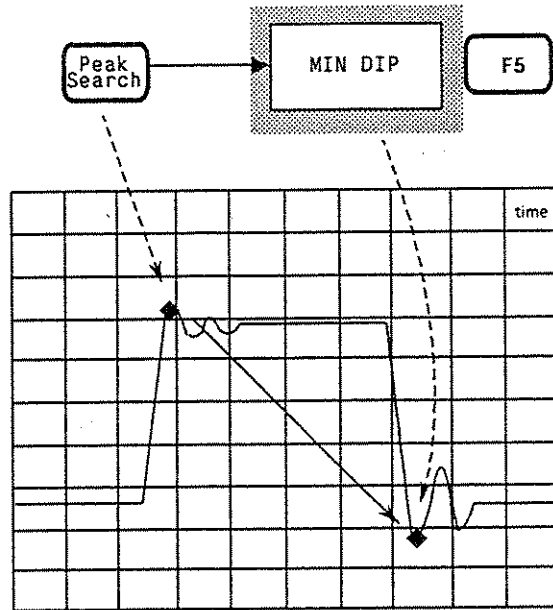

3.3.4 NEXT DIP search

The next smallest dip relative to the current marker level is detected and the marker is moved to that point. (When there are two or more dips with the same level on the screen, the leftmost dip is detected)

Execute the NEXT DIP search by using the following key operations.

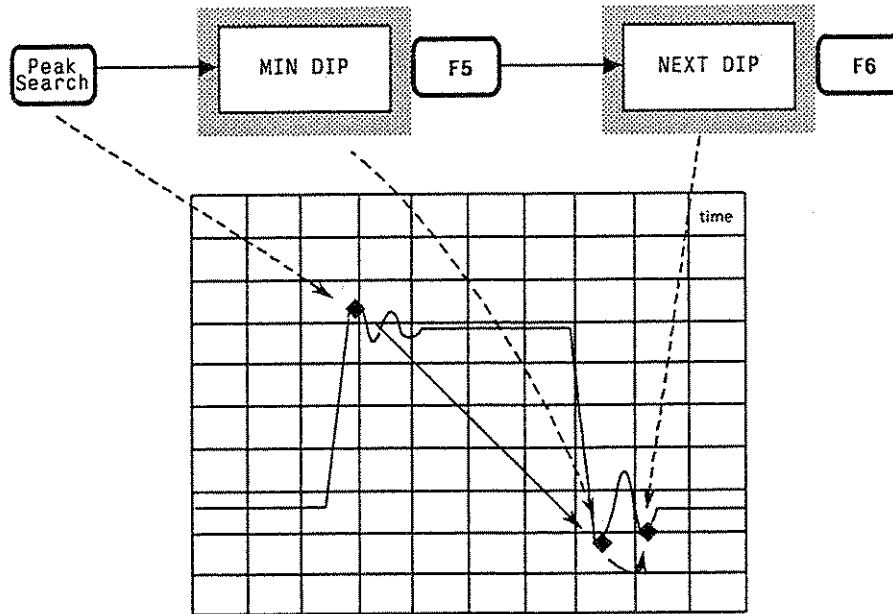

The consecutive NEXT DIP search execution allows the next smallest peaks to be detected one after another for marker movement to the detected point.

3.3.5 NEXT RIGHT PEAK search / NEXT LEFT PEAK search

The adjacent peak level to the right or left of the current marker level is detected and the marker is moved to that point.

Execute NEXT RIGHT PEAK search / NEXT LEFT PEAK search by using the following key operations.

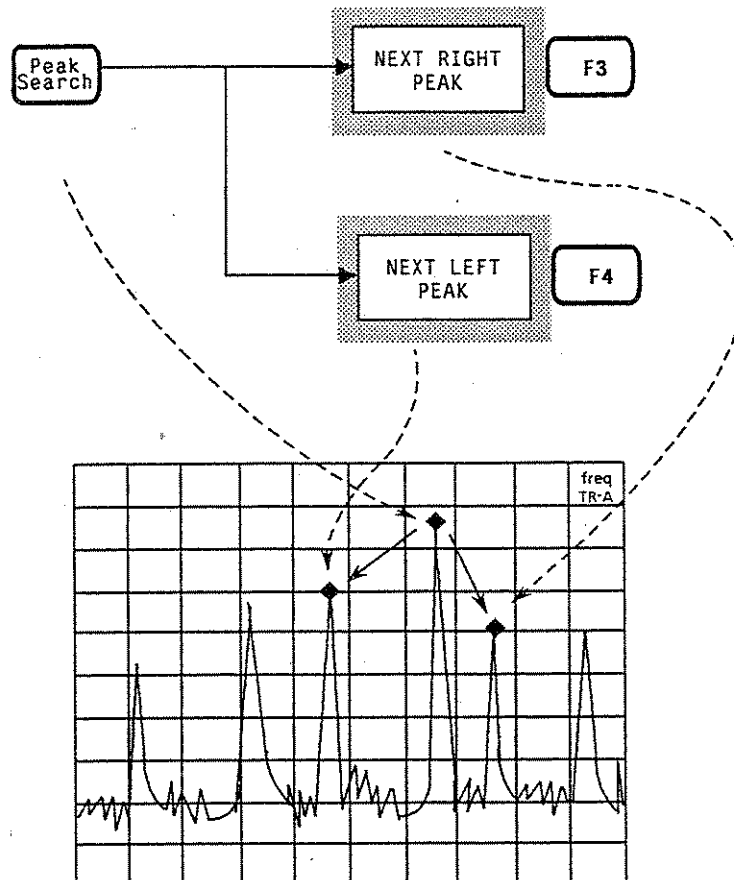

The consecutive NEXT RIGHT PEAK search / NEXT LEFT PEAK search execution allows the adjacent peak level to the right or left to be detected one after another for marker movement to the detected point.

Note: When marker search is executed, the marker is moved to the specified PEAK or DIP point, and the zone marker center frequency simultaneously moves to the marker point. After that, when the sweep is executed within the zone marker, the marker moves to the maximum point within the zone marker. Therefore, the marker search except PEAK search should be executed with the sweep stopped or with the zone width set to 1 point (spot marker mode).

3.4 Setting Parameters Using Marker Values

The marker value can be set as the parameter value of the observation frequency, reference level, and so on. This facilitates observation of the desired waveform.

To set parameters using the marker value, five types of settings are possible as follows:

- MKR → CF: Sets marker frequency to center frequency.
- MKR → REF: Sets marker level to reference level.
- MKR → CF STEP SIZE: Sets marker frequency to center frequency step size.
- Δ MKR → SPAN: Sets the frequencies at the reference marker and current marker points to the start and stop frequencies, respectively.
- ZONE → SPAN: Sets the center frequency and zone width of the zone marker to the center frequency and frequency span, respectively.

These parameter settings during time domain mode are valid only for MKR → REF.

3.4.1 MKR → CF / MKR → REF

The frequency and level at the current marker can be set to the center frequency and reference level respectively, by performing the following key operations.

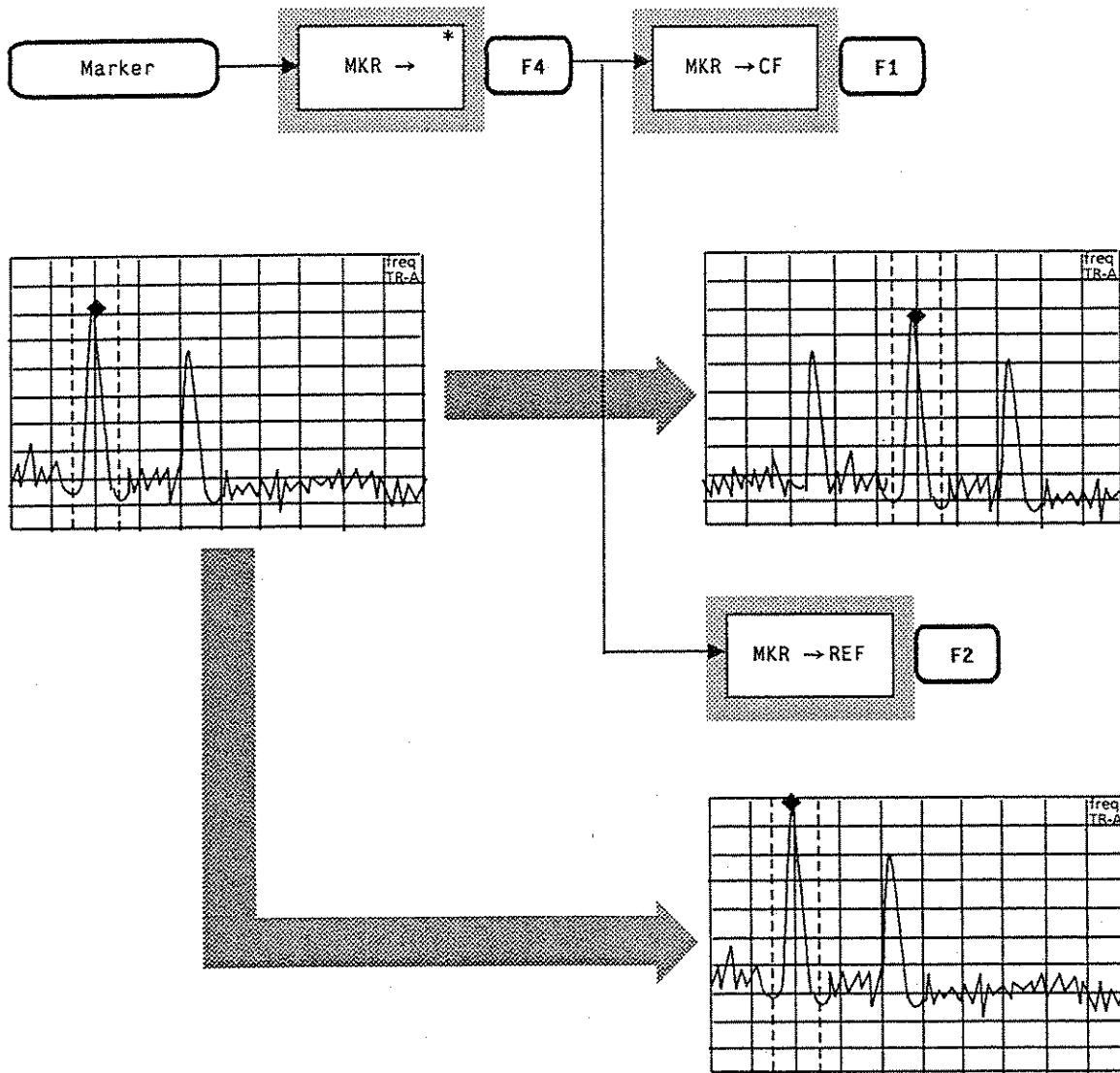

The MKR → CF can also be executed by the operations shown below.

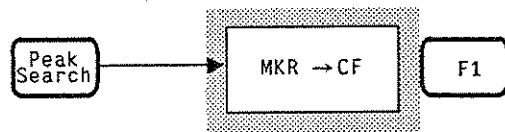

In this case, the peak search is also executed. This is convenient for moving the peak signal in the observation frequency range to the center frequency.

3.4.2 MKR → CF STEP SIZE

The marker frequency can be registered to the step size ([\vee] [\wedge] keys resolution) of the center frequency by performing the following key operations.

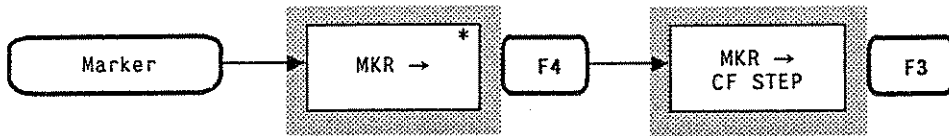

Although this action does not cause any change to appear on the screen, the center frequency can be changed with the marker frequency value registered when the step size as the center frequency is changed with the [\vee] [\wedge] keys. This facilitates observation of harmonic waves.

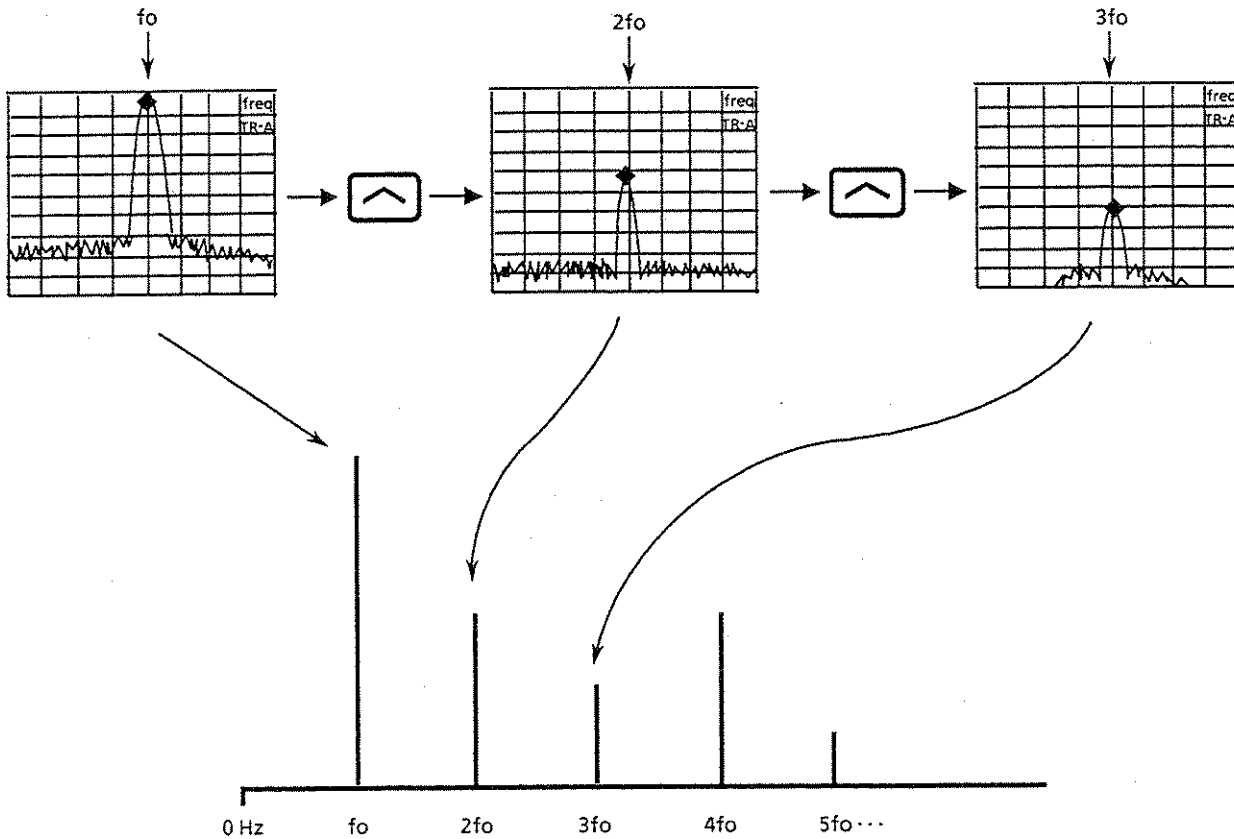

3.4.3 Δ MKR \rightarrow SPAN

In delta marker mode, set the current marker and reference marker frequencies to the start and stop frequencies as follows.

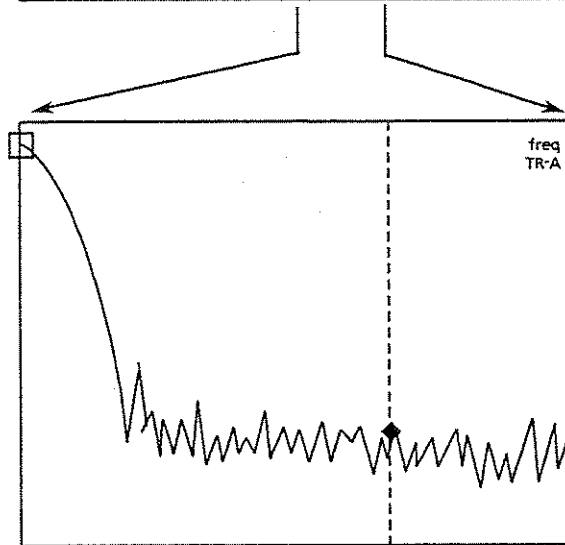
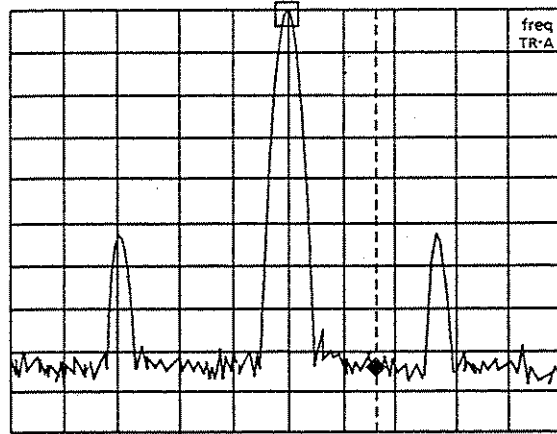
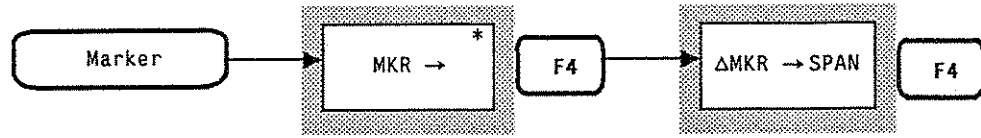

The current marker position remains unchanged

Since the reference marker is fixed relative to the frequency, it moves to the extreme left when the frequency span is changed

3.4.4 ZONE → SPAN

Set the center frequency and zone width of the zone marker to the center frequency and frequency span as follows.

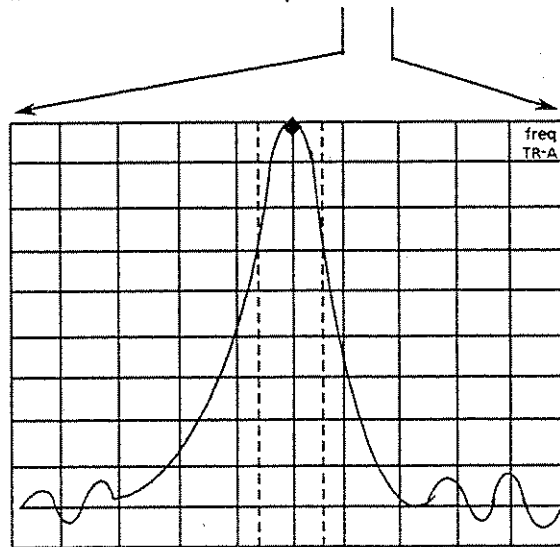
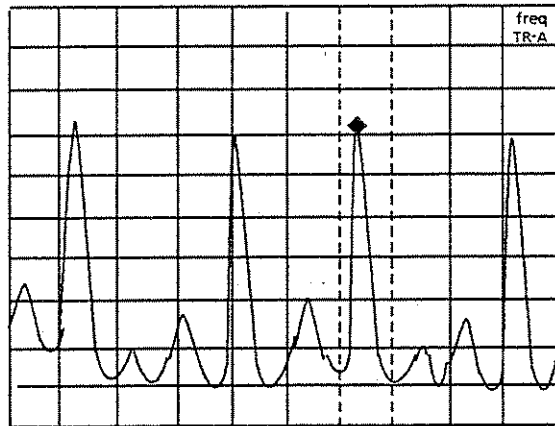
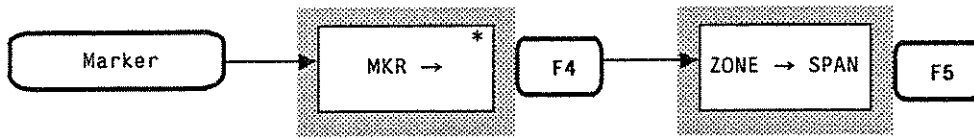

The zone width remains unchanged

3.5 Display Line

The display line is a horizontal line which represents a given level (frequency deviation when the FM demodulation waveforms are displayed) within the scale. The line can be used as a guide line for frequency response measurement or a reference line for marker level measurement.

3.5.1 Setting the display line

Turn the display line ON/OFF and set the display level (frequency deviation) as follows:

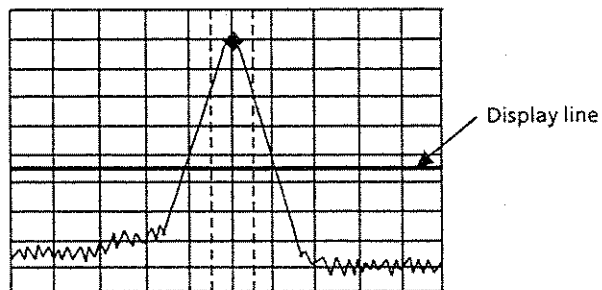
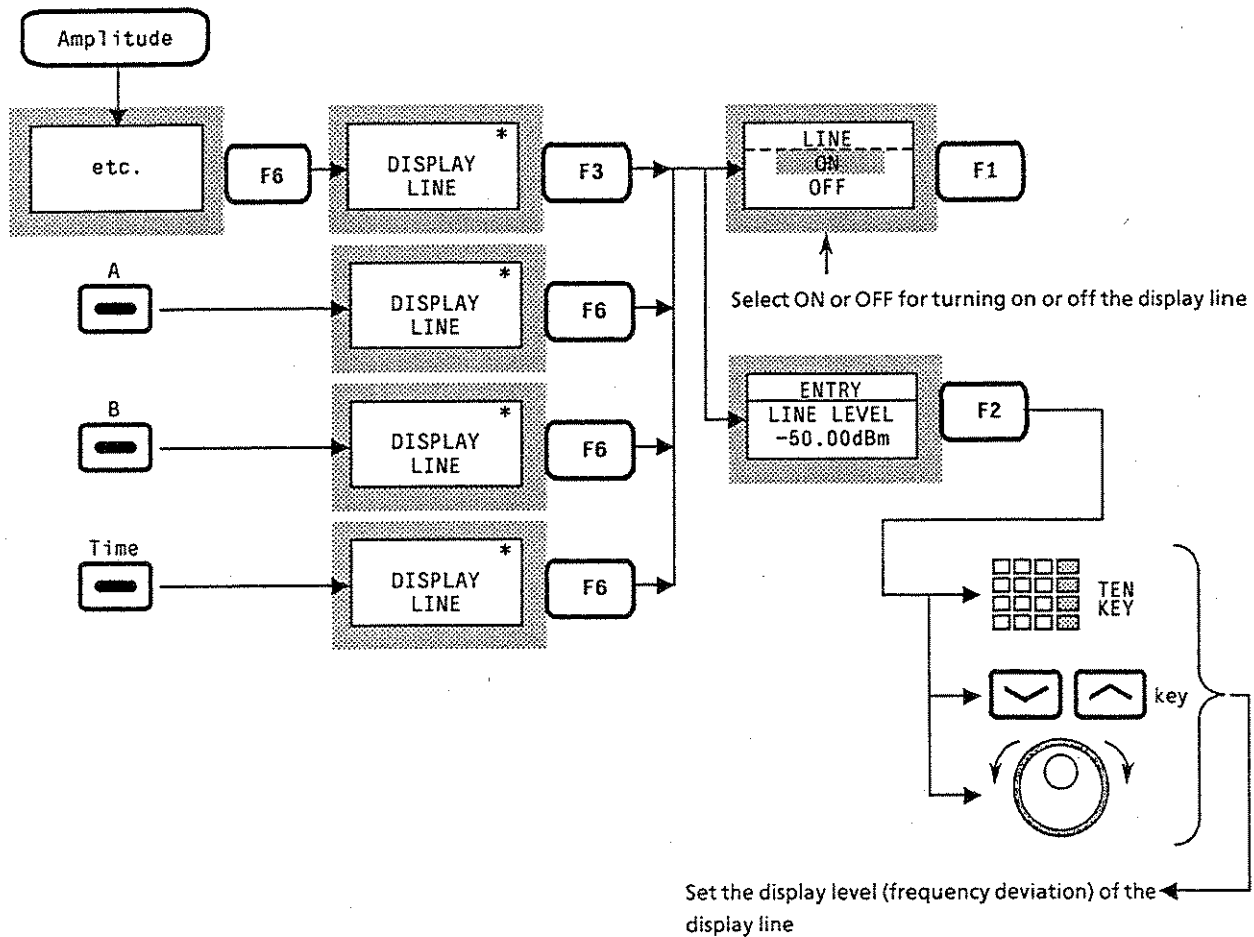

The display line can be switched ON or OFF for all traces (A, B, BG, TIME). The display level of the display line can be set except when FM demodulation waveforms are displayed.

The display line cannot be displayed when monitoring an external trigger signal.

Since the display line is displayed as an absolute value, the display line position on the scale is shifted by modifying the reference level or scale.

3.5.2 Displaying the marker level from the reference position of the display line

The following key operation allows the marker level display to be changed to the relative display when the display line is positioned as a reference.

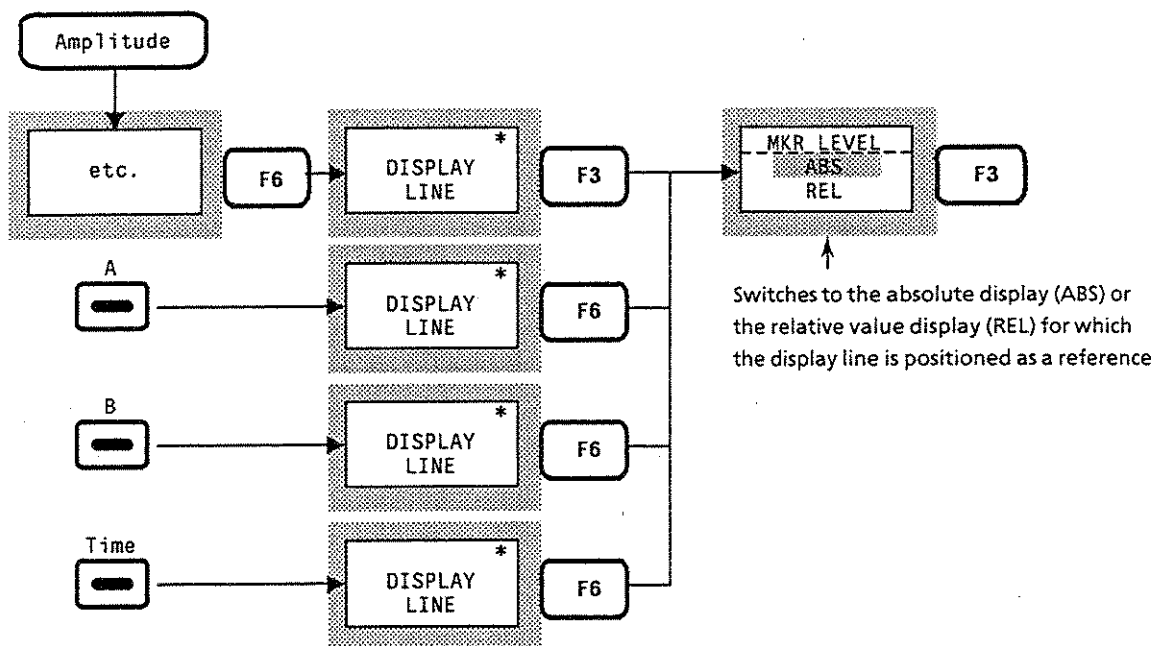

The ABS/REL parameter can be selected separately for each trace.

SECTION 4

SIGNAL SEARCH FUNCTION

The signal search function provides a quick way to search for the signal to be measured. Although the functions of signal search are similar to the marker function, this section describes the Signal Search section which is usually treated as a separate procedure from the marker function.

TABLE OF CONTENTS

4.1	Detecting Peaks	4-3
4.1.1	Detecting the maximum peak signal by automatic tuning	4-3
4.2	Moving the Measurement Point	4-4
4.2.1	PEAK → CF and PEAK → REF	4-5

SECTION 4

SIGNAL SEARCH FUNCTION

4.1 Detecting Peaks

To detect the peak of the MS2602A spectrum waveform, three types of functions can be used as follows:

- AUTO TUNE
- ZONE MARKER
- TRACKING

This section explains only the AUTO TUNE function. For ZONE MARKER and TRACKING, see SECTION 3, MARKER FUNCTIONS and SECTION 6, SELECTING SWEEP METHOD, respectively.

4.1.1 Detecting the maximum peak signal by automatic tuning

Pressing the [Auto Tune] key detects the maximum peak signal within the Back Ground (BG) and sets that signal frequency and level to the center frequency and reference level, respectively.

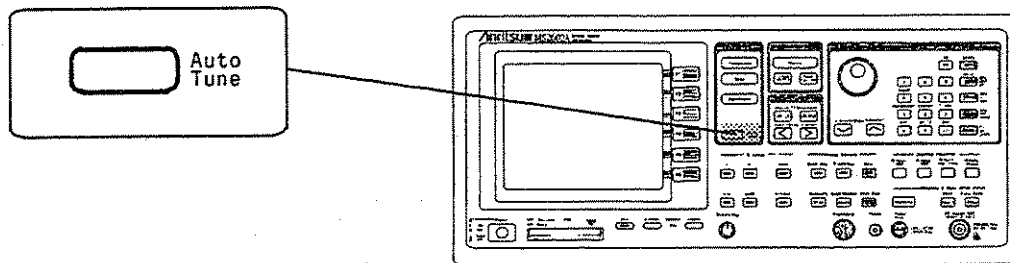

- Notes:**
- When executed at a frequency span of more than 100 MHz, the frequency span is set to 100 MHz. When executed at a frequency span of less than 100 MHz, the value is retained.
 - When executed in the DISPLAY mode of trace Time, the switching is made for trace A / Time, whose main trace is trace Time. Also, EXPAND mode is set to OFF.
 - Input attenuator is set to AUTO.
 - The frequency range at AUTO TUNE executed in the initial state is 0.85 MHz to 8.5 GHz. By changing the trace BG frequency range, the frequency range at AUTO TUNE can also be set as follows.

Start frequency: Start frequency specified in trace BG. Provided the range of 0 Hz to one-hundredth the span frequency is omitted.

Stop frequency: Stop frequency specified in trace BG

4.2 Moving the Measurement Point

This function can move a spectrum on the screen to the center to facilitate measurement. Five types of functions can be used as follows:

- MKR → CF: Sets the marker frequency to the center frequency.
- MKR → REF: Sets the marker level to the reference level.
- PEAK → CF: Sets the frequency at the maximum peak point on the screen to the center frequency.
- PEAK → REF: Sets the level at the maximum peak point on the screen to the reference level.
- SCROLL: Scrolls the observation frequency.

This paragraph explains only PEAK → CF and PEAK → REF functions. For MKR → CF and MKR → REF see SECTION 3, MARKER FUNCTIONS, and for SCROLL see SECTION 2, FREQUENCY / AMPLITUDE DATA ENTRY.

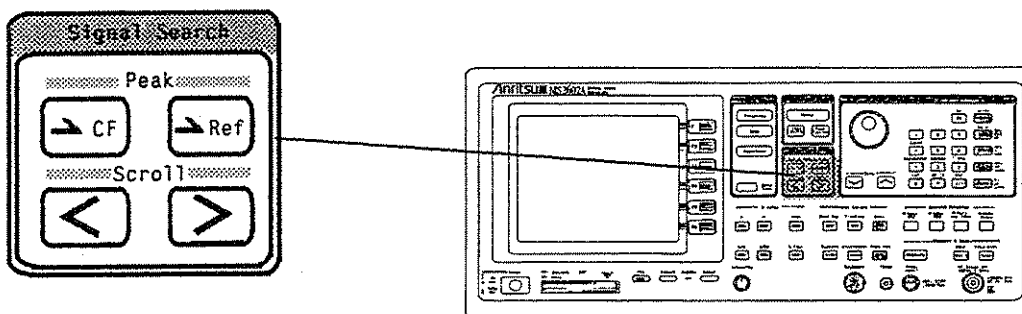

4.2.1 PEAK → CF and PEAK → REF

The PEAK → CF and PEAK → REF functions set the maximum level value displayed on the screen to the center frequency and reference level, respectively, and move the peak point to the center of the frequency axis on the screen and to the top level axis, respectively.

(1) PEAK → CF



Sets the maximum peak point to the center frequency, and the zone marker to the center frequency as well.

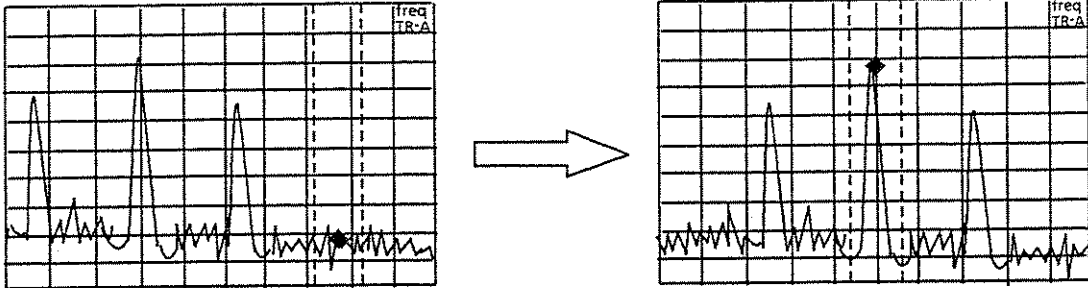

- Notes:**
- When the frequency at the maximum peak point is less than 0 Hz, the center frequency is set to 0 Hz.
 - If there are two or more maximum peak points with the same level on the screen, the peak point with the lowest frequency is moved to the center frequency.
 - PEAK → CF malfunctions while any of the following items is being used.
 - ① Zone sweep ON
 - ② Time domain
 - ③ A / Time is specified in the A < Time mode
 - ④ A / BG or BG FULL SPAN is specified in the A < BG mode

(2) PEAK → REF



Sets the maximum peak level to the reference level.

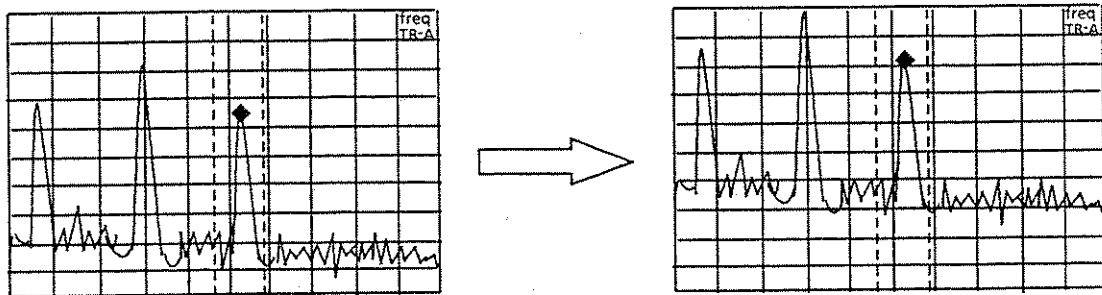

Note: If the level at the peak point exceeds the permitted range for the reference level, the reference level is set to the maximum (minimum) reference level that can be set.

SECTION 5

SELECTING THE DISPLAY METHOD

This section gives a detailed description of the display mode (trace A, B, TIME, A / B, A / BG, A / TIME), storage mode (NORMAL, VIEW, MAX HOLD, MIN HOLD, AVERAGE, CUMULATIVE, OVER WRITE), detection mode (POSITIVE PEAK, SAMPLE, NEGATIVE PEAK), and time domain analysis.

TABLE OF CONTENTS

5.1	DISPLAY Mode	5-3
	5.1.1 Trace A	5-5
	5.1.2 Trace B	5-6
	5.1.3 Trace Time	5-7
	5.1.4 Trace A/Trace B	5-8
	5.1.5 Trace A/Trace BG	5-9
	5.1.6 Trace A/Trace Time	5-10
5.2	Storage Mode	5-11
	5.2.1 Selecting storage mode	5-13
	5.2.2 Setting storage mode during simultaneous display mode	5-14
	5.2.3 Digital video averaging	5-15
5.3	Detection Mode	5-18
	5.3.1 Selecting detection mode	5-19
	5.3.2 Selecting the measured level by detection mode	5-20
5.4	Time Domain	5-21
	5.4.1 Setting time domain	5-21
	5.4.2 Setting TIME SPAN	5-22
	5.4.3 EXPAND functions	5-23
	5.4.4 Monitoring FM demodulation waveforms	5-25
	5.4.5 Monitoring external trigger signal	5-27

(Blank)

SECTION 5

SELECTING THE DISPLAY METHOD

The MS2602A can display four types of trace modes (BG †, A, B, Time) using six types of DISPLAY modes (A, B, Time, A/B, A/BG, A/Time).
 In the DISPLAY mode, six types of keys are used in the Display section shown in the diagram below.

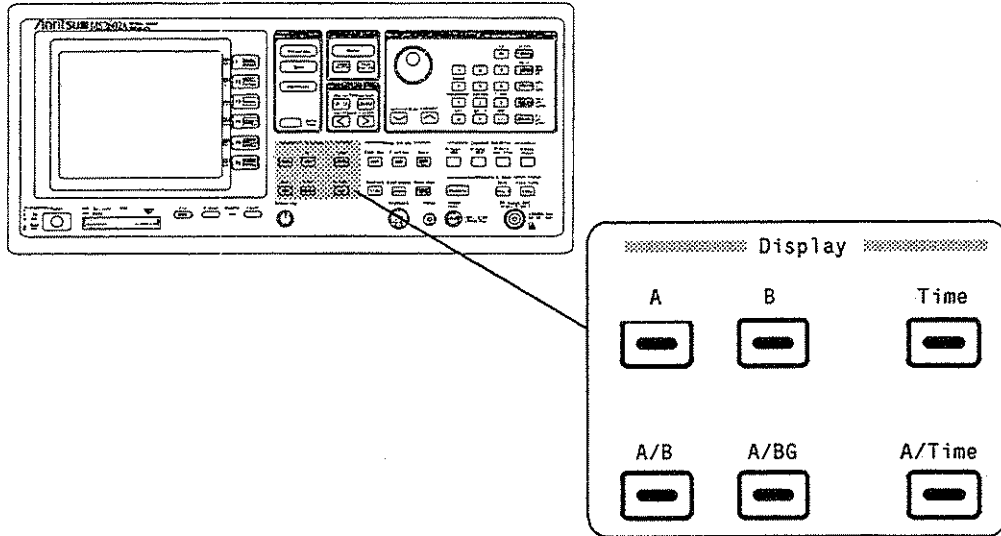

5.1 DISPLAY Mode

An outline of the trace modes is described below, and the correlation between respective trace modes is shown in the diagram on the next page.

- Trace BG When the objective signal is measured in trace A, B, or Time mode, the trace BG mode allows the frequency range to be observed to be pre-set to a wide band. The BG band is initially set to full span (0 to 8.5 GHz).
- Trace A, Trace B Used to analyze signals in the normal frequency domain. The BG zone within trace BG, which is expanded for display, corresponds to trace A or trace B.
- Trace Time Displays the time axis waveform at the center frequency of trace A or trace B. FM and EXT TRIG signals, when monitored, can also be displayed by the trace Time.

† BG (Back Ground)

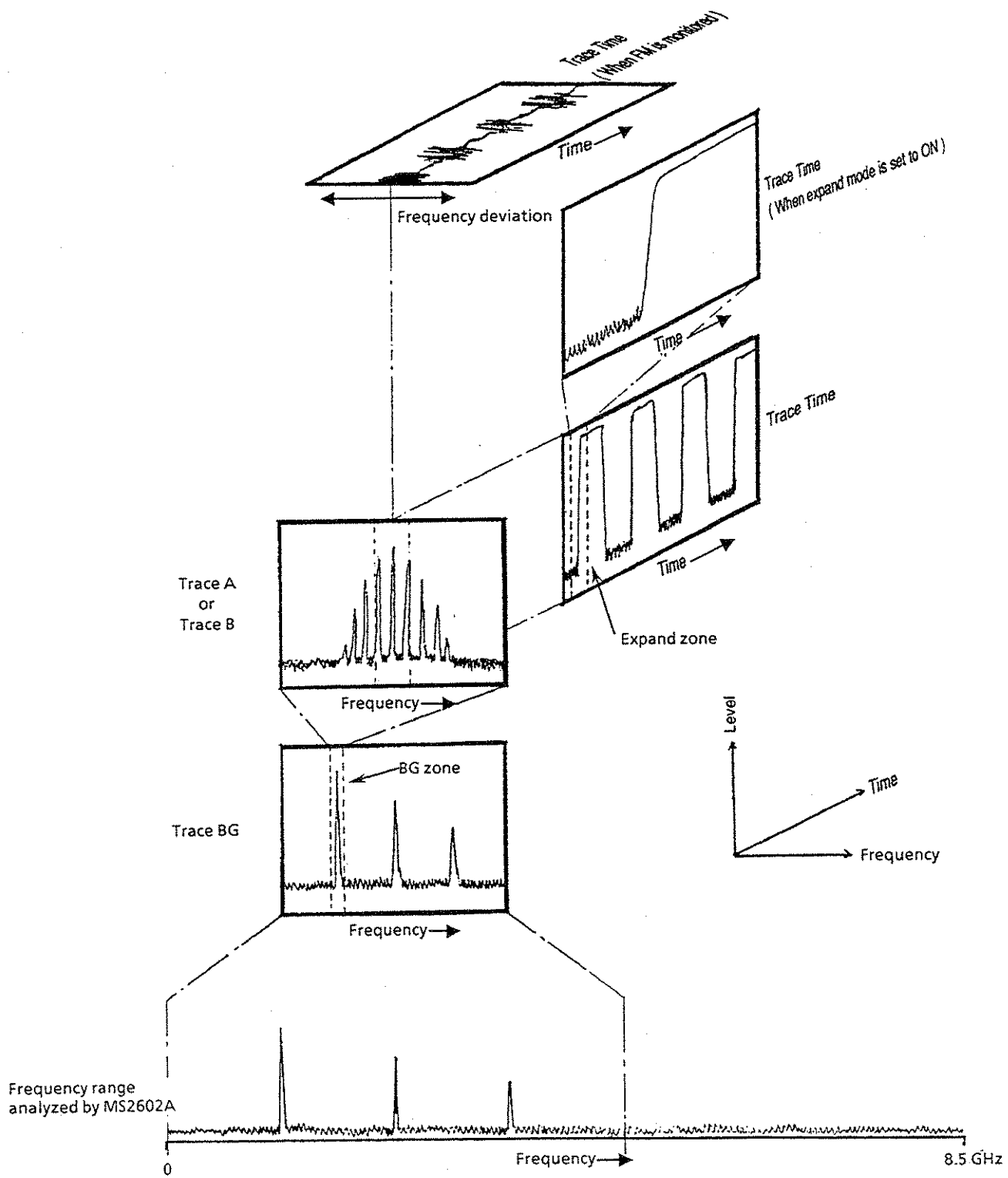

The DISPLAY mode can be directly selected using six types of keys in the Display section. When a mode key in the section is selected, the LED lamp of the selected key lights up green.

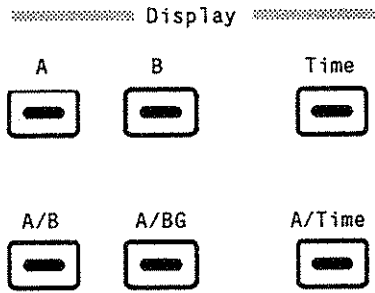

5.1.1 Trace A

Trace A is used to analyze signals in the normal frequency domain. To display trace A, press the [A] key.

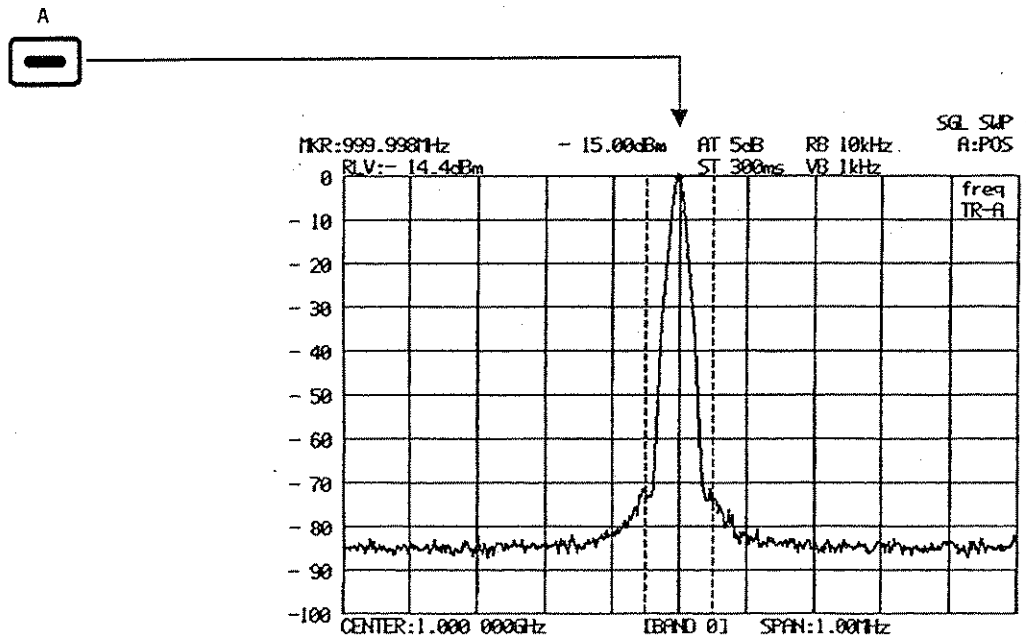

5.1.2 Trace B

Like trace A, trace B is used to analyze signals in the normal frequency domain. When used with trace A, it is possible to make a comparison and calculation between waveform A and waveform B. To display trace B, press the [B] key.

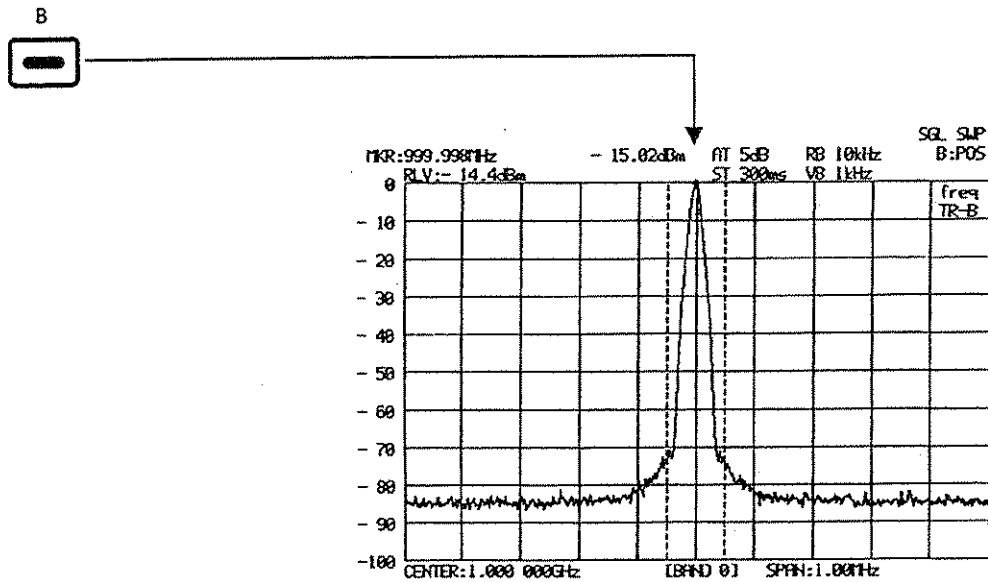

All parameters except the storage mode settings (MAX HOLD, MIN HOLD, AVERAGE, CUMULATIVE, OVER WRITE) and detection mode (POS PEAK, SAMPLE, NEG PEAK) are used common to both trace A and trace B.

5.1.3 Trace Time

The trace Time displays the time axis waveform at the center frequency of trace A or trace B. To display trace Time, press the [Time] key.

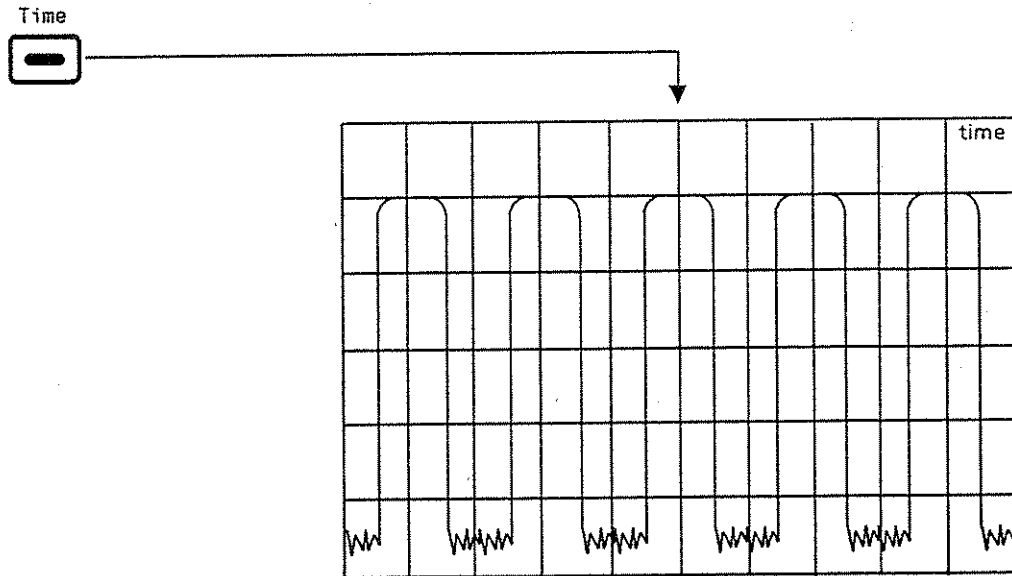

All parameters except the scale settings, storage mode settings (MAX HOLD, MIN HOLD, AVERAGE, CUMULATIVE, OVER WRITE), and detection mode (POS PEAK, SAMPLE, NEG PEAK) are common to both trace A and trace Time. However, the following parameters can be used separately.

(See page 9-6.)

- Resolution band width (RBW)
- Video band width (VBW)
- Sweep time (Sweep Time / Time Span)

In addition to normal level display, the trace Time allows an FM demodulation waveform from an input signal, and an input signal waveform from an external trigger to be displayed.

(See page 5-26 and page 5-28.)

5.1.4 Trace A / Trace B

Both trace A and trace B can be displayed simultaneously. To display both traces simultaneously, press the [A/B] key.

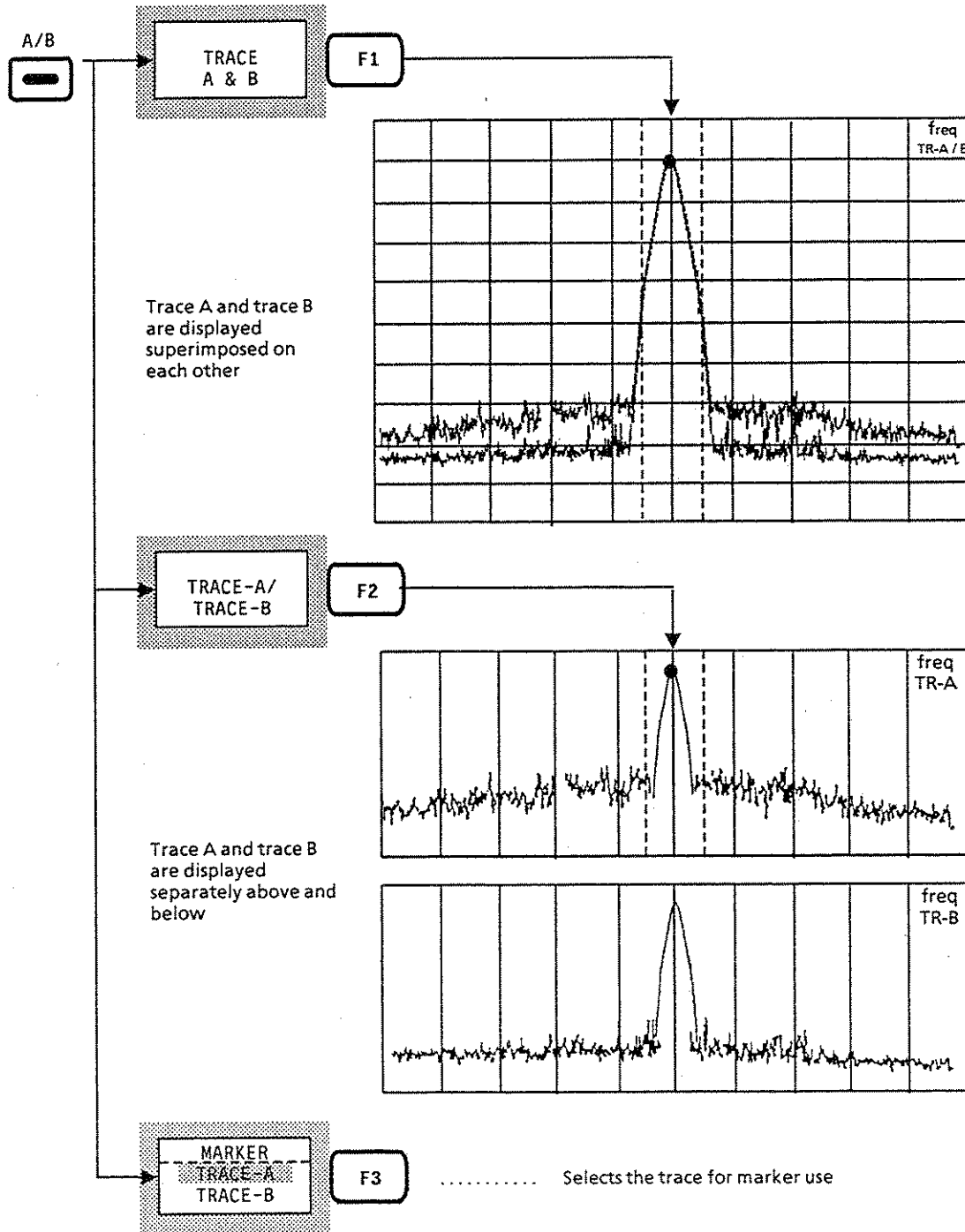

All parameters except the storage mode settings (MAX HOLD, MIN HOLD, AVERAGE, CUMULATIVE, OVER WRITE) and detection mode (POS PEAK, SAMPLE, NEG PEAK) are common to both trace A and trace B. Detection mode also becomes common while the gate function is used.

5.1.5 Trace A/Trace BG

Both trace A and trace BG can be displayed simultaneously. This mode is used to extract and analyze the special and selected signals from a wide frequency range. To display both traces simultaneously, press the [A /BG] key.

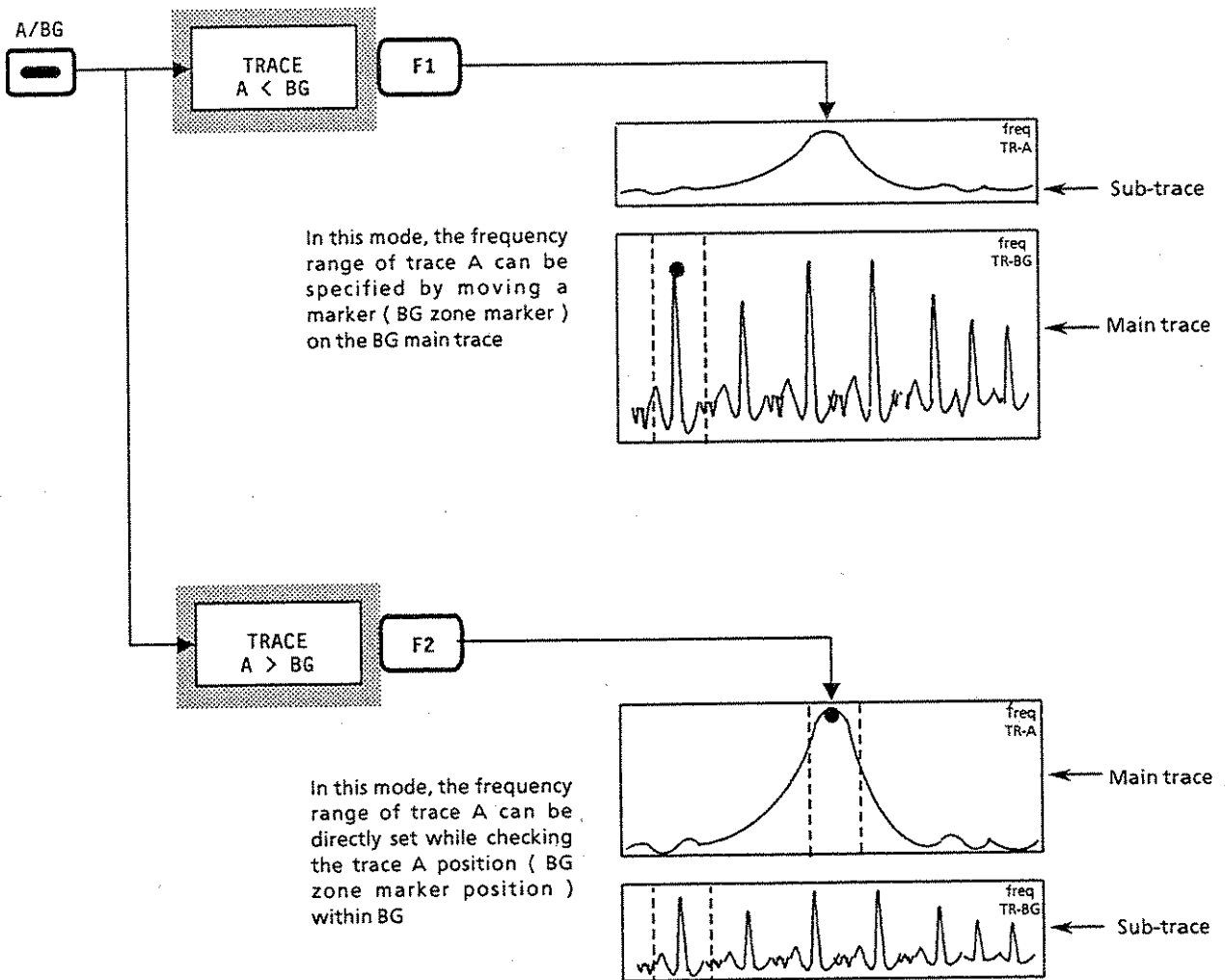

The parameters associated with the reference level, vertical axis scale, and input attenuator settings are used common to both trace A and trace BG, and other parameters can be used independently. Each parameter can be set in the main trace (larger displayed side). Marker operation is available only for the main trace.

5.1.6 Trace A / Trace Time

Both trace A and trace Time can be displayed simultaneously. To display both traces, press the [A / Time] key.

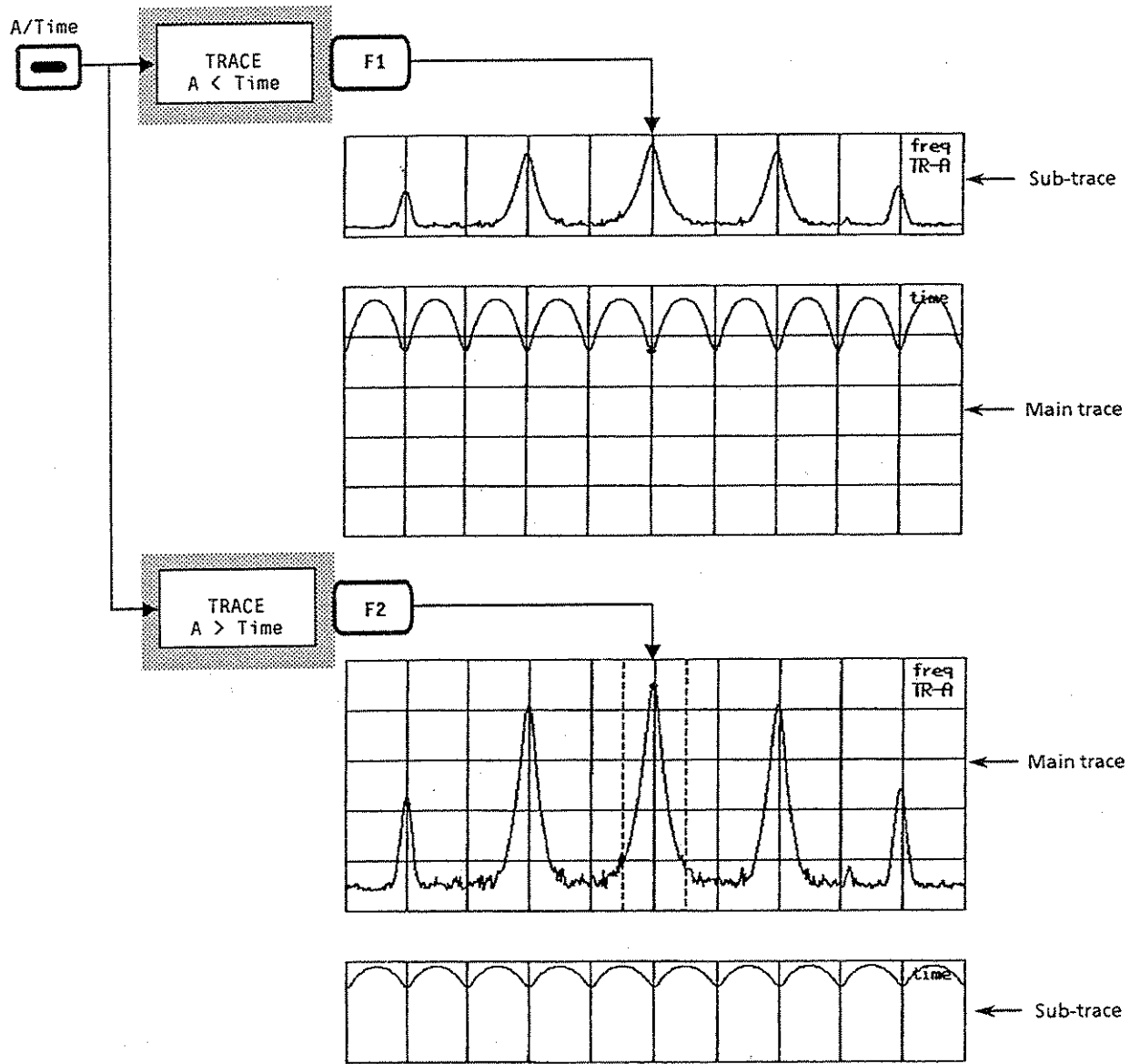



Each parameter can be set in the main trace (larger displayed side). The common parameters (center frequency, reference level, input attenuator, resolution bandwidth during coupled mode common in system setting, video bandwidth, etc) are set on either main trace side, and they are also transformed accurately into either sub-trace. Marker operation is available only for the main trace.

5.2 Storage Mode

The following seven types of trace modes can be selected for DISPLAY modes trace A, trace B, and trace Time.

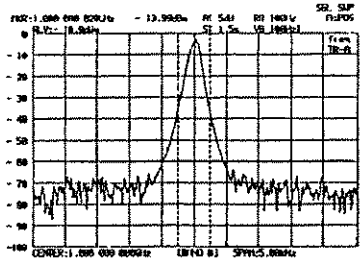
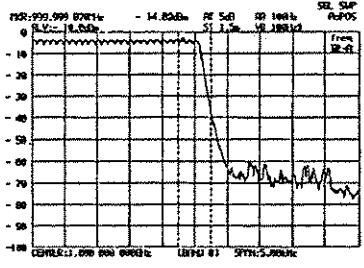
Types of Trace Modes (1 / 2)

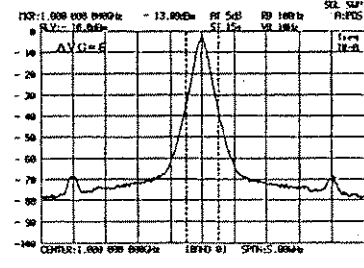
NO.	Mode	Explanation	Display example
1	NORMAL	Refreshes and displays trace data at each sweep. This is used for normal measurement.	 <p>The display shows a noisy signal on a grid. A prominent peak is visible at approximately 13.000 Hz. The y-axis ranges from -100 to 0, and the x-axis ranges from 0 to 100. The signal is labeled 'TRAC' and 'TR-A'.</p>
2	MAX HOLD	At each sweep, compares new trace data with previous data at points on each X axis, then displays the larger value data. For example, MAX HOLD may be used to record a frequency-drifting signal.	 <p>The display shows a signal that has shifted to the right compared to the normal mode. The peak is now at approximately 14.000 Hz. The y-axis ranges from -100 to 0, and the x-axis ranges from 0 to 100. The signal is labeled 'TRAC' and 'TR-A'.</p>
3	MIN HOLD	At each sweep, compares new trace data with previous data at points on each X axis, then displays the smaller value data.	 <p>The display shows a signal that has shifted to the left compared to the normal mode. The peak is now at approximately 12.000 Hz. The y-axis ranges from -100 to 0, and the x-axis ranges from 0 to 100. The signal is labeled 'TRAC' and 'TR-A'.</p>
4	AVERAGE	At each sweep, calculates average data at points on each X axis, then displays the averaged results. This mode is used to improve S/N. For further details on the averaging function, see page 5-15.	 <p>The display shows a smooth signal with a peak at approximately 13.000 Hz. The y-axis ranges from -100 to 0, and the x-axis ranges from 0 to 100. The signal is labeled 'TRAC' and 'TR-A'.</p>

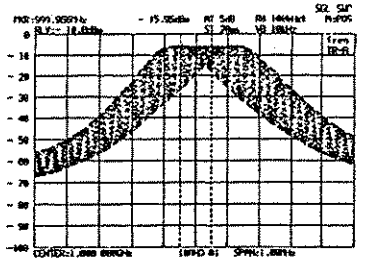
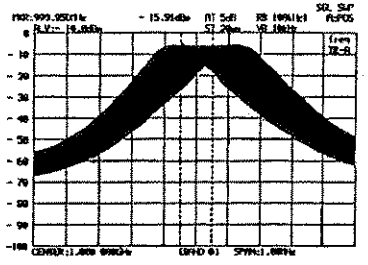
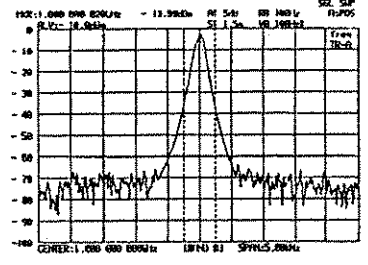
NO.	Mode	Explanation	Display example
5	CUMULATIVE	Displays the cumulative waveform at each sweep. The waveform data, which are not connected by lines, are displayed by plotting the data.	 <p>The display shows a noisy waveform on a grid. The vertical axis ranges from 0 to -100. The horizontal axis is labeled with 'CENTER: 1.000 000Hz', 'SPAN: 1.000Hz', and 'TRIG: 1.000Hz'. The waveform consists of many individual data points from multiple sweeps, creating a dense, textured appearance.</p>
6	OVERWRITE	Displays the waveform overwritten without deleting the previous trace data	 <p>The display shows a solid black waveform on a grid, identical in shape to the one in the CUMULATIVE mode. The axes and labels are the same. The waveform is a single, thick, solid black trace.</p>
7	VIEW	Continues displaying the waveform as it is, without refreshing the currently-displayed trace data. This mode is used to observe waveforms with the trace data stopped temporarily, or for hard-copying.	 <p>The display shows a single waveform trace on a grid. The vertical axis ranges from 0 to -100. The horizontal axis is labeled with 'CENTER: 1.000 000Hz', 'SPAN: 1.000Hz', and 'TRIG: 1.000Hz'. The waveform is a single trace with a noisy baseline and a prominent peak.</p>

5.2.1 Selecting storage mode

Any one of the trace modes can be selected by operating the function keys shown below while the MS2602A is operating in trace A, trace B, or trace Time.

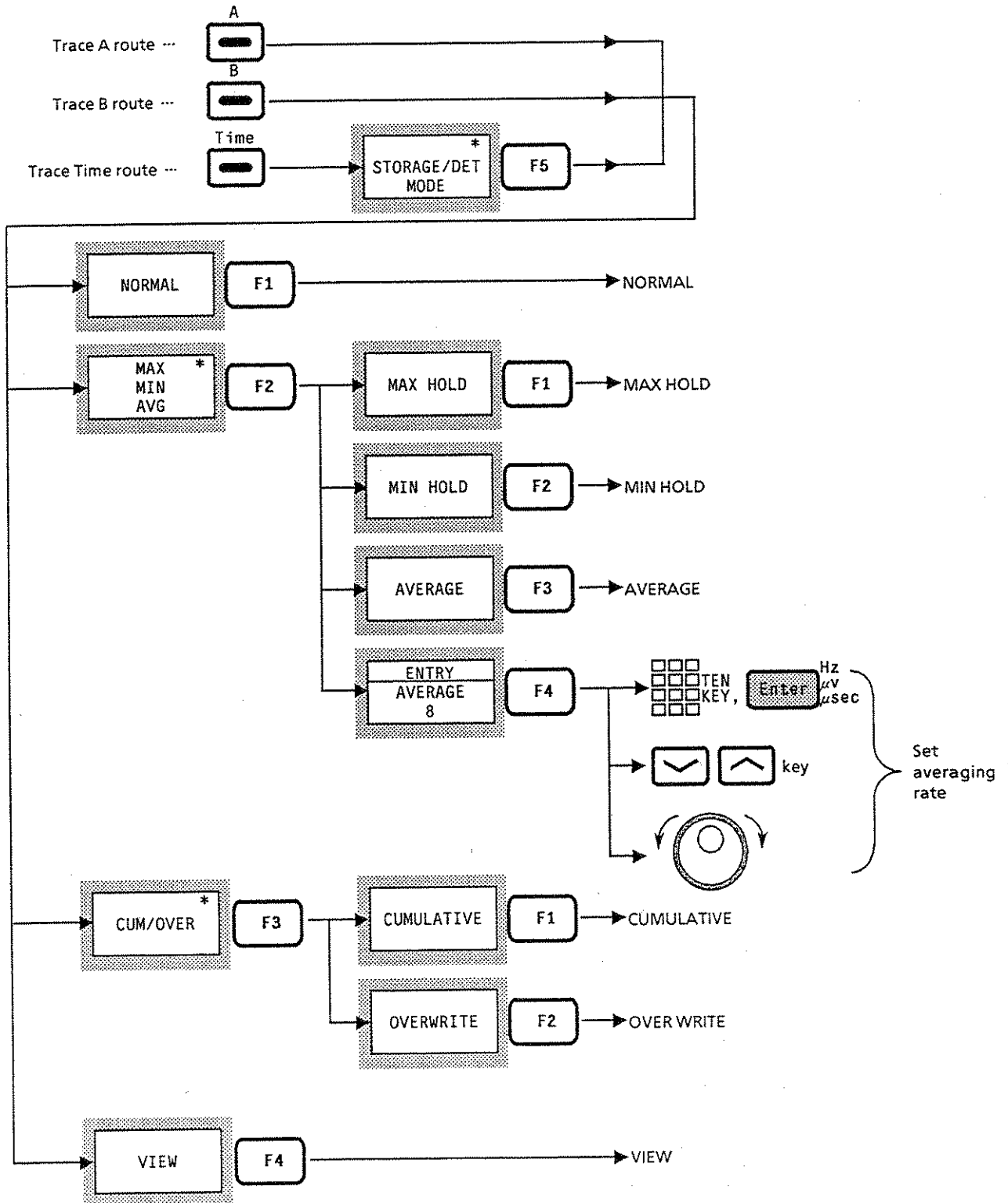

5.2.2 Setting storage mode during simultaneous display mode

In the simultaneous display mode of A / B, A / BG, and A / Time, the WRITE / VIEW switching works as follows.

- Trace A / Trace B Switches WRITE / VIEW in trace B.

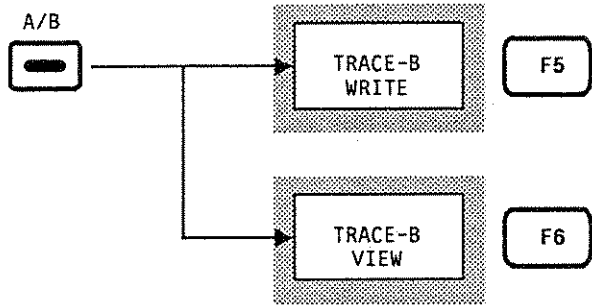

- Trace A / Trace BG Switches WRITE / VIEW in sub-trace (smaller displayed trace).

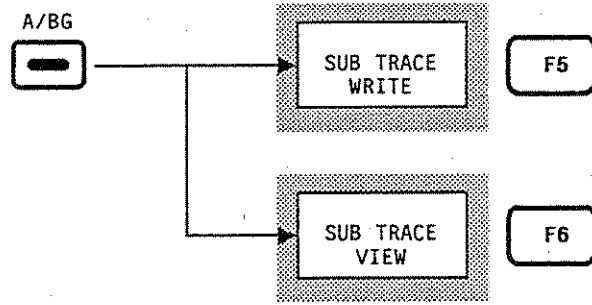

- Trace A / Trace Time Switches WRITE / VIEW in sub-trace (smaller displayed trace).

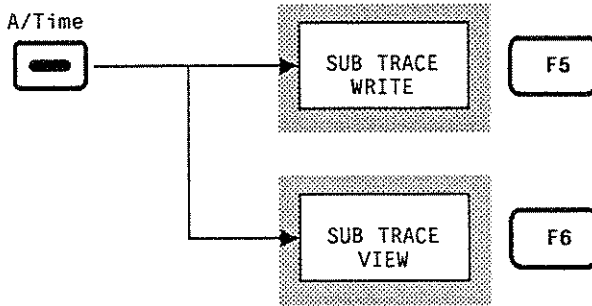

The WRITE displays the storage mode which is selected in trace A, trace B, or trace Time.

5.2.3 Digital video averaging

The digital averaging function calculates average data at points on each X axis at each sweep and displays the results. It is executed by selecting 'AVERAGE' in the respective DISPLAY modes which are trace A, trace B, and trace Time. The averaging rate can be set anywhere in the range 2 to 1024.

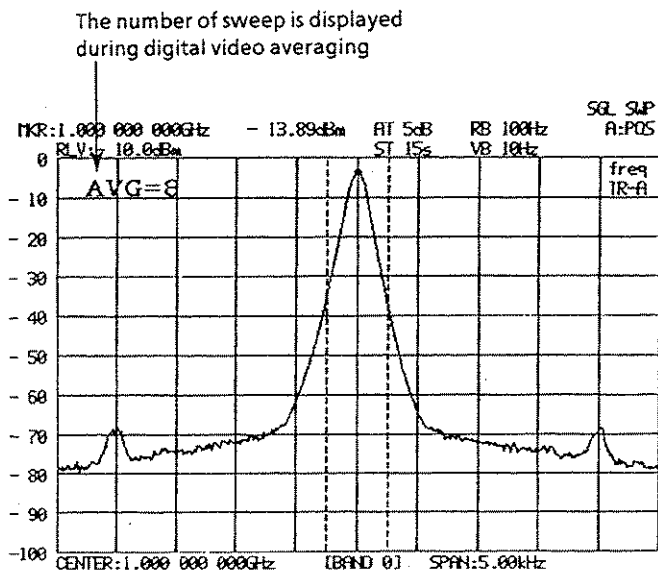
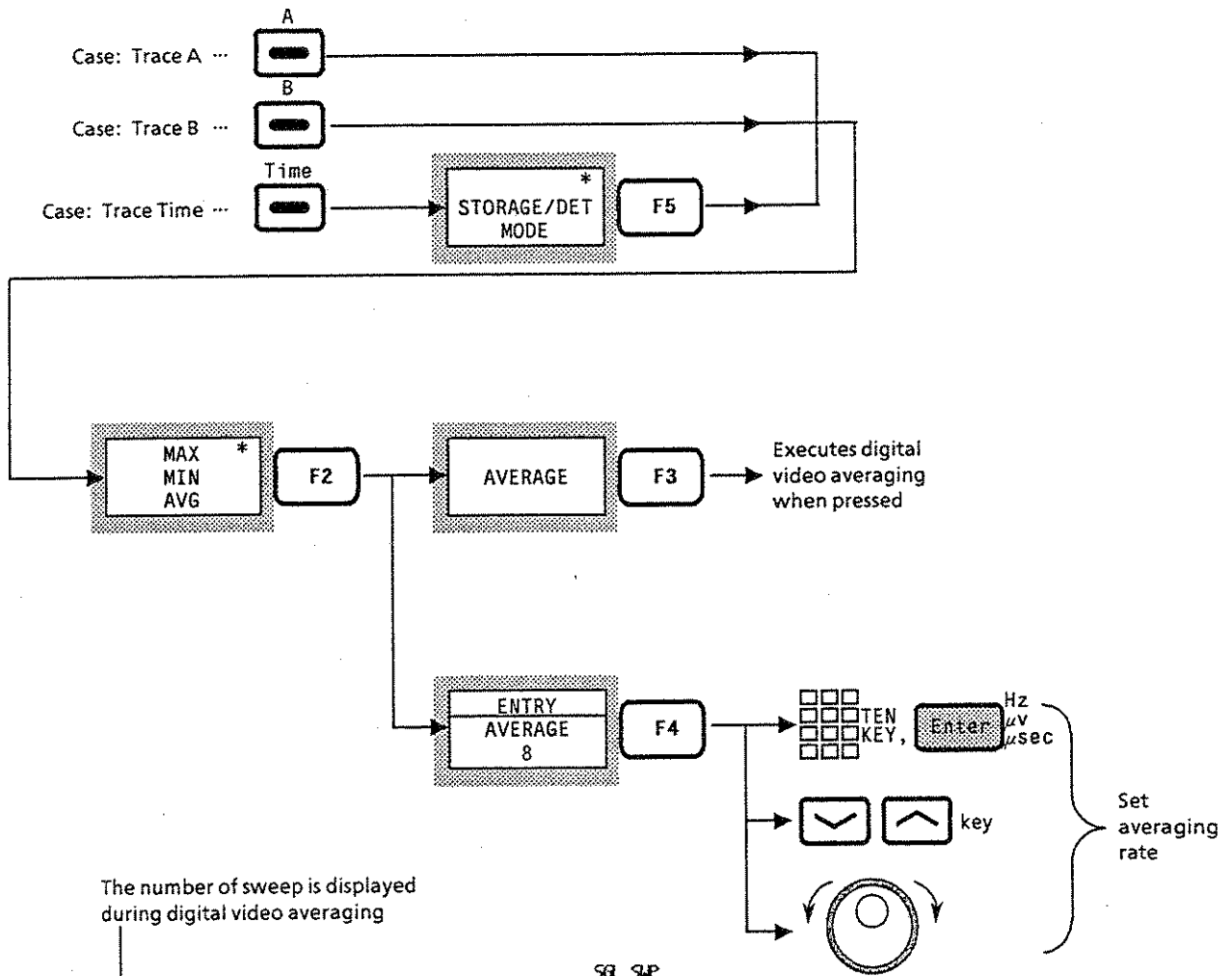

The digital video averaging function improves S/N depending on the averaging rate and the number of sweep repetitions as shown in the diagram on the next page. The following shows an example of digital video averaging when the averaging rate is N.

Averaging Rate = N

Number of sweeps	Measured value	Displayed value
1	M(1)	$Y(1) = M(1)$
2	M(2)	$Y(2) = Y(1) + \frac{M(2) - Y(1)}{2}$
3	M(3)	$Y(3) = Y(2) + \frac{M(3) - Y(2)}{3}$
⋮	⋮	⋮
N - 1	M(N - 1)	$Y(N - 1) = Y(N - 2) + \frac{M(N - 1) - Y(N - 2)}{N - 1}$
N	M(N)	$Y(N) = Y(N - 1) + \frac{M(N) - Y(N - 1)}{N}$
N + 1	M(N + 1)	$Y(N + 1) = Y(N) + \frac{M(N + 1) - Y(N)}{N}$
N + 2	M(N + 2)	$Y(N + 2) = Y(N + 1) + \frac{M(N + 2) - Y(N + 1)}{N}$
⋮	⋮	⋮

③ RESTART

↓

① STOP

↓

② CONT

↓

- ① The sweep stops after N repetitions.
- ② The above stop condition is released by setting the Sweep Control to Continuous. The averaging operation resumes, while counting the number of sweep repetitions as N + 1, N + 2 . . .
- ③ When the Sweep Control is set to Restart with the sweep executed or stopped, the averaging operation starts the number of sweep repetitions from N + 1.

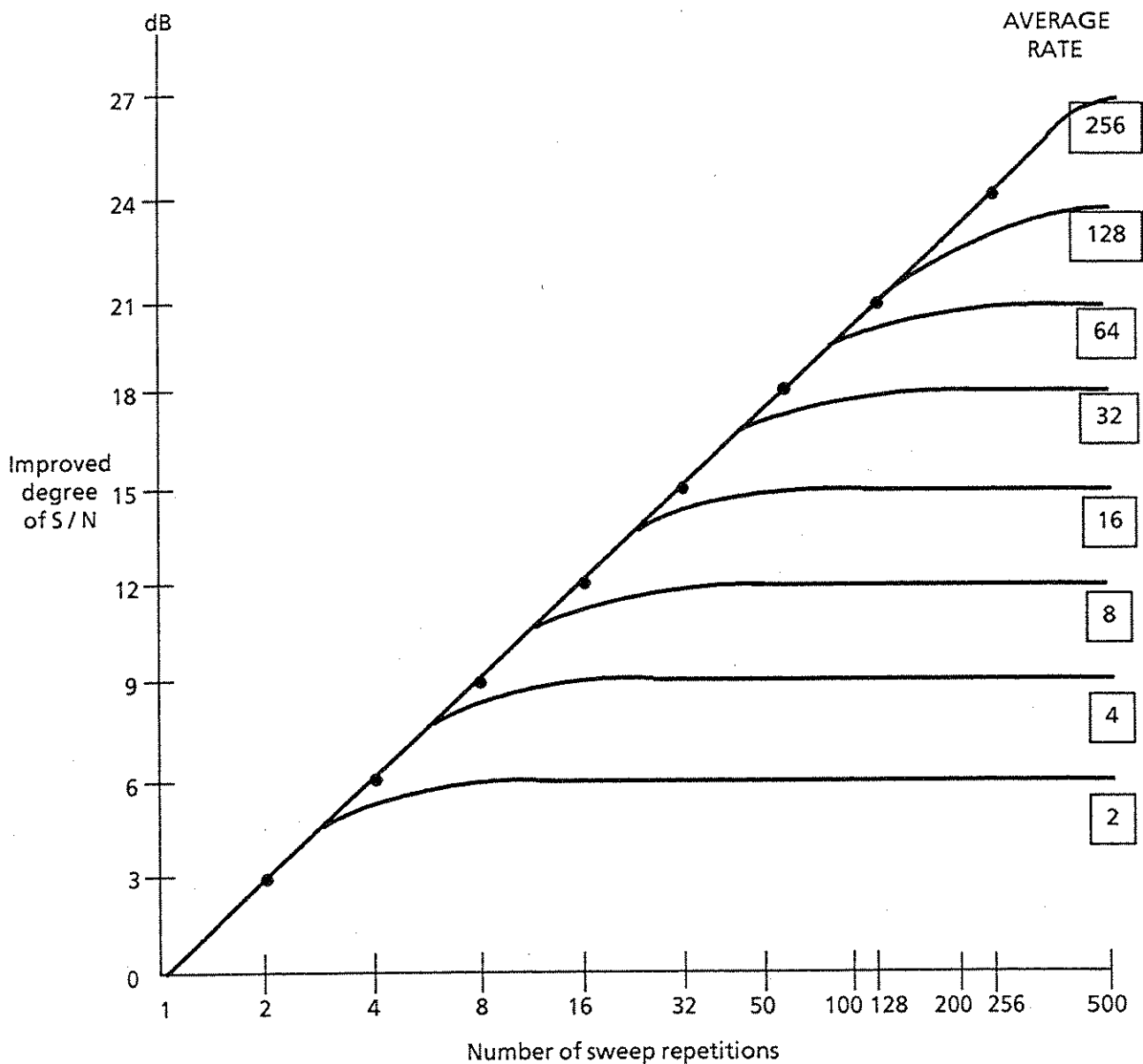

S / N Improvement by Digital Video Averaging

Averaging by the video filter has the disadvantage that the sweep time becomes longer when the video bandwidth is narrowed to improve the averaging effect.

On the other hand, the digital video averaging smooths the trace display by averaging the digital data after A / D conversion at each sweep, without narrowing the video bandwidth. Since the VIDEO BW gets comparatively wider and the time required for each sweep can be shortened, the entire spectrum image can be verified quickly and the repetitive sweep can be stopped when the required smoothing has been obtained. The problem of averaging with the video filter is that the time required for each sweep becomes longer and it takes a long time to verify the entire spectrum image.

Since the averaging rate is initially 8, the above diagram shows that an S / N improvement of 9 dB is obtained with the 8 times sweep.

5.3 Detection Mode

There are three types of detection mode: POSITIVE PEAK, SAMPLE, NEGATIVE PEAK. One mode can be selected in trace A and trace B, respectively.

POSITIVE PEAK	Detects a positive peak, then traces the maximum value in sample points
SAMPLE	Traces the instantaneous value in sample points
NEGATIVE PEAK	Detects a negative peak, then traces the minimum value in sample points

Provided the detection mode of trace BG is fixed to POSITIVE PEAK. When the time span is set to less than 50 ms in trace Time mode, the detection mode is set to SAMPLE only.

5.3.1 Selecting detection mode

Select the detection mode for trace A, trace B, or trace Time as follows:

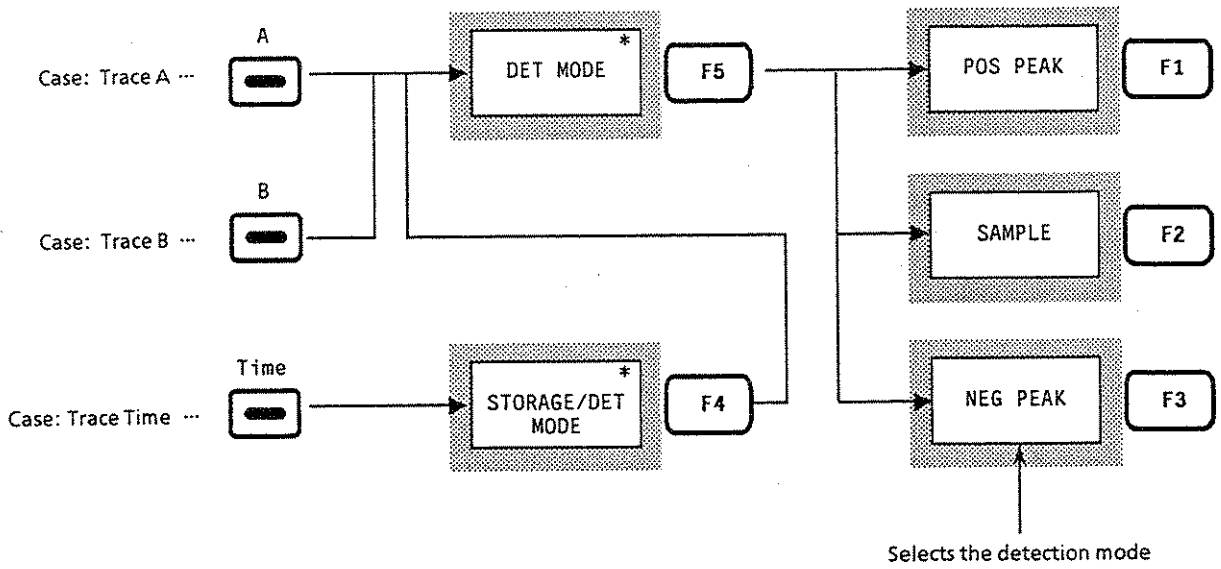

The selected detection mode is displayed at the top right-hand corner of the screen in combination with DISPLAY mode.

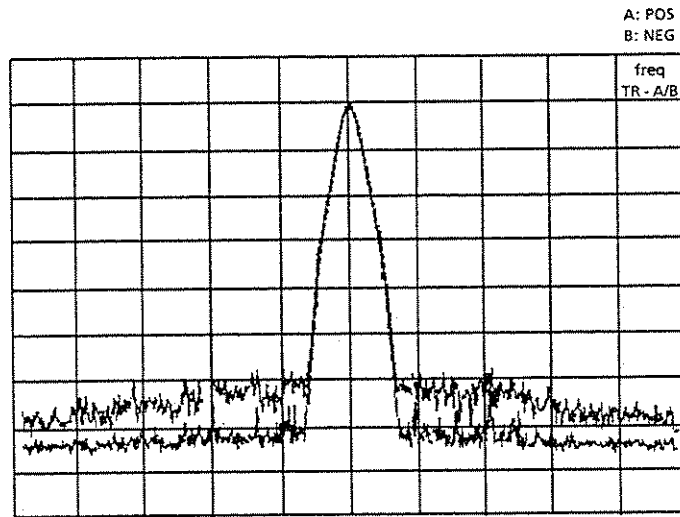

5.3.2 Selecting the measured level by detection mode

The MS2602A has 501 and 1002 horizontal-axis measurement sample points† corresponding to 501 and 1002 trace memories, respectively.

The detection mode determines what type of measured value should be stored in trace memory at each measurement sample point.

Detection mode	Description
POSITIVE PEAK	Holds the maximum level present between the current sample point and the next sample point, then stores the maximum value in the trace memory corresponding to the current sample point. Since the POSITIVE PEAK mode can accurately display the peak value of signals similar to the noise level in various noises, it is often used for normal measurement.
SAMPLE	Stores the instantaneous signal level at each sample point in trace memory. The SAMPLE mode is used for noise level measurement, time domain measurement, and other measurements for which instantaneous values are required.
NEGATIVE PEAK	Holds the minimum level present between the current sample point and the next sample point, then stores the minimum value in the trace memory corresponding to the current sample point. The NEGATIVE PEAK mode is used for measuring the lower envelope side of a modulated waveform.

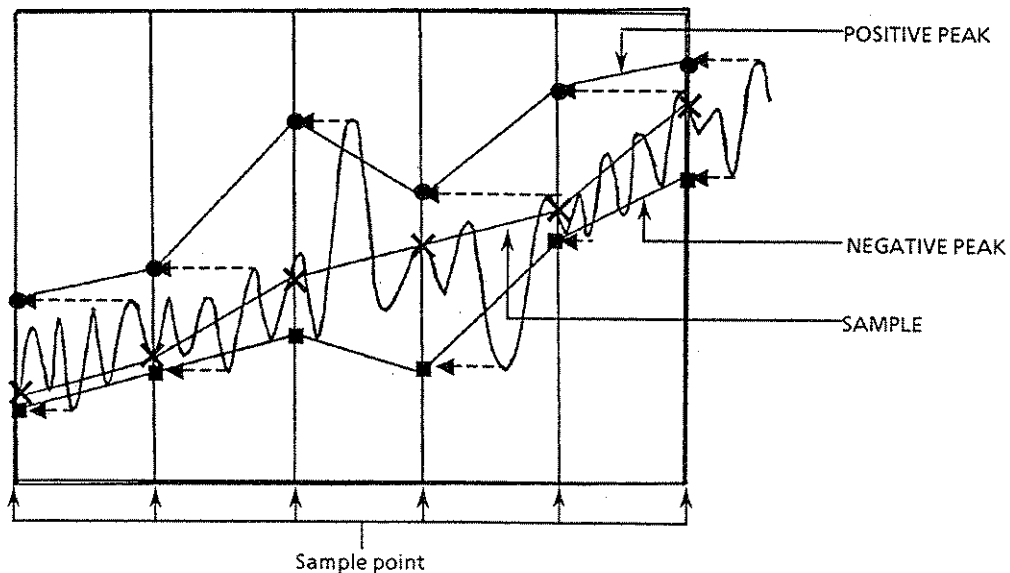

Note: When the detection mode is set to SAMPLE or NEGATIVE PEAK while the frequency span and resolution bandwidth are set so that the spectrum is displayed as discrete vertical lines, the spectrum peak is incorrectly displayed.

† The horizontal-axis measurement point of the MS2602A can select either of the two types, 501 points or 1002 points. For details of the selection method, see the system settings on page 9-4.

5.4 Time Domain

Since the spectrum analyzer stops sweeping the frequency when set to the frequency span of 0 Hz, the spectrum analyzer becomes a selective level meter that continues receiving only the center frequency. In this case, the horizontal axis of the time-axis sweep waveform is graduated in time and displayed on the screen of the spectrum analyzer. This display method is called time domain display.

The MS2602A time domain display provides an EXPAND function for expanding the waveform time axis to create a more convenient display. It also has a special display function for monitoring an FM demodulation waveform and an external trigger signal.

5.4.1 Setting time domain

The time domain can normally be set by pressing the [Time] key in the Display section. It can also be set by setting the frequency span to 0 Hz in the frequency domain mode.

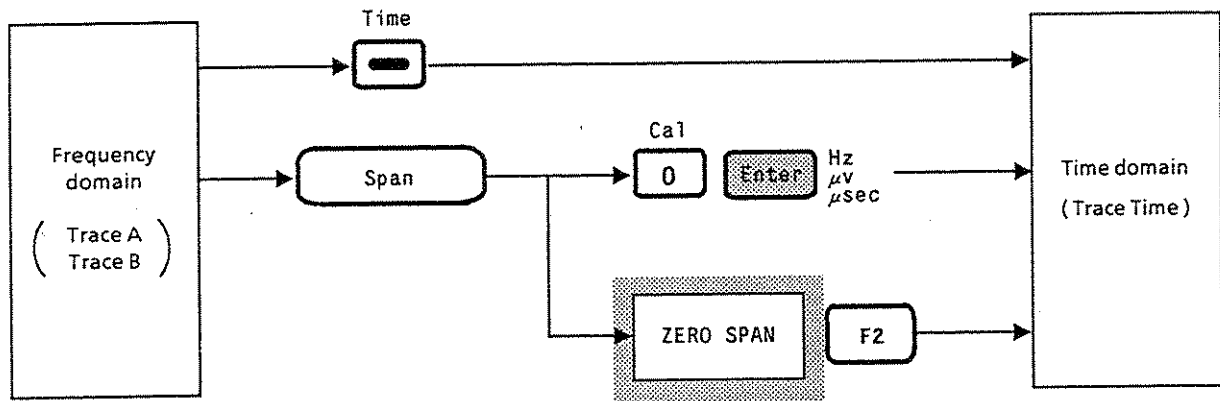

The following parameters can be set independently in the frequency domain or time domain.

- Vertical scale mode (LOG / LIN)
- Vertical scale range (10 dB / div, 10 % / div)
- Storage mode (NORMAL, MAX HOLD, AVERAGE)
- Detection mode (POS PEAK, SAMPLE, NEG PEAK)
- Resolution bandwidth(RBW)
- Video bandwidth(VBW)
- Sweep time (SWEEP TIME / TIME SPAN)
- Trigger switch (FREE RUN / TRIGGERED)

The three parameters of resolution bandwidth, video bandwidth, and sweep time can be selected common or independent in frequency domain or time domain when setting the system.
For further details, see the system settings on page 9-6.

Note: The marker function for time domain uses a spot marker because of the unused zone marker.

5.4.2 Setting TIME SPAN

In time domain, the measurement range on the horizontal axis does not set the frequency span, but sets time span. To set the time span, perform the following key operations.

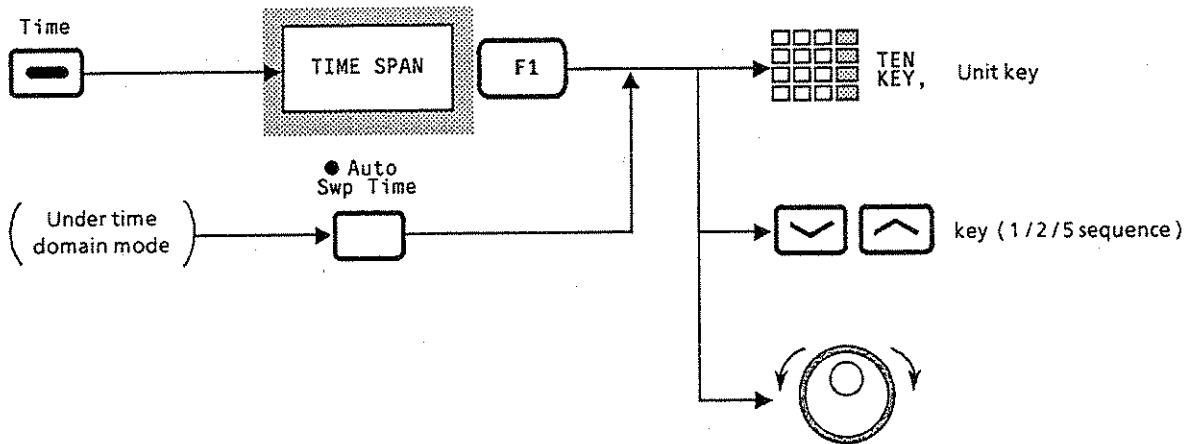

The time span setting range is as follows:

- 50 μ sec to 1000 sec (for 501 data points)
- 100 μ sec to 1000 sec (for 1002 data points)

Note: Setting the time span to less than 50 ms places the high speed A/D converter into use, and results in the level measurement deteriorated by 0.1 dB resolution.

5.4.3 EXPAND functions

In time domain mode, one part of the time axis can be expanded for clarity. The range to be expanded is set using EXPAND ZONE.

To set the EXPAND function, perform the following key operations.

(1) Setting EXPAND ZONE

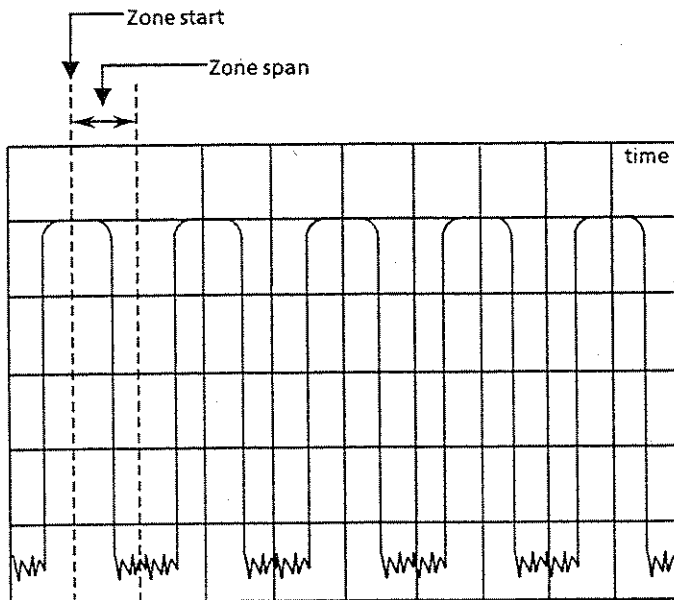
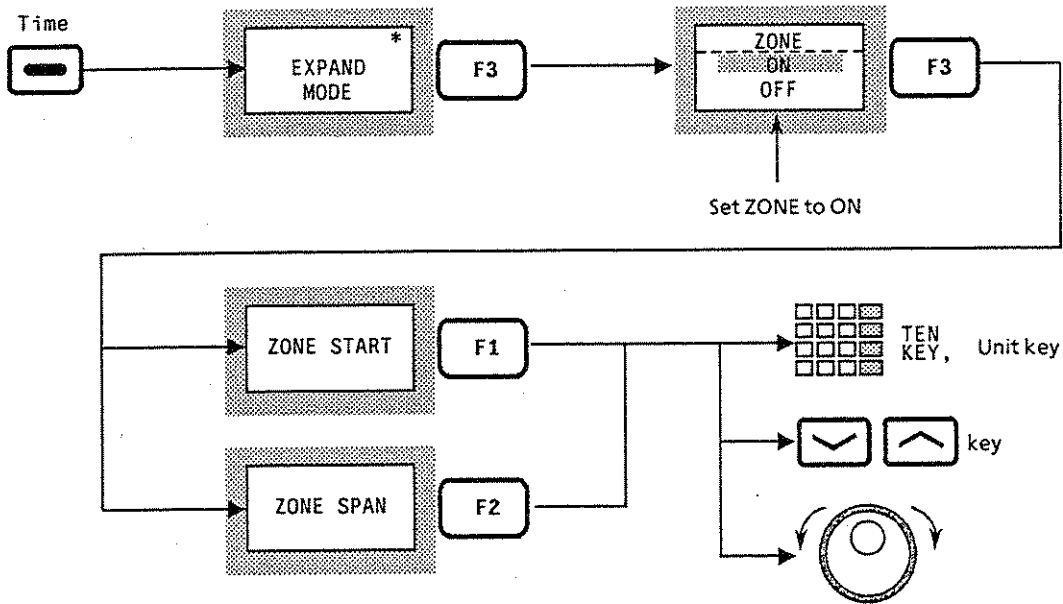

(2) EXPAND ON / OFF

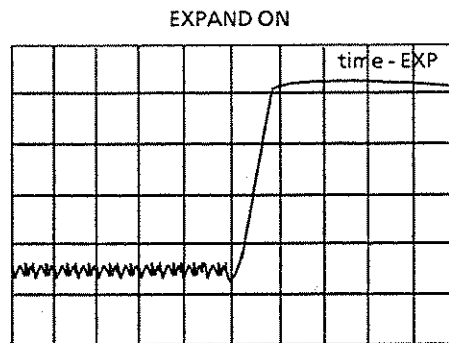
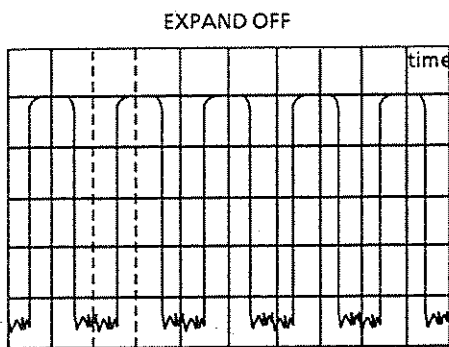
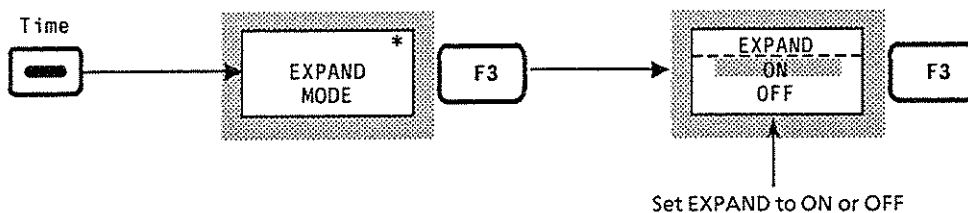

Under the following conditions, EXPAND mode cannot be executed.

- Trigger mode FREE RUN
- ZONE START 65.5 msec
- ZONE SPAN Less than 50 μ sec (100 μ sec when data point is set to 1002)
- ZONE START + ZONE SPAN Less than 0 sec
- Display mode Monitoring FM or EXT TRIG

5.4.4 Monitoring FM demodulation waveforms

The MS2602A incorporates an FM demodulator to display demodulation waveforms.

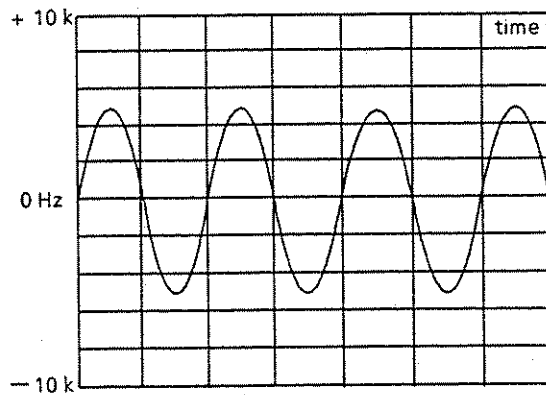
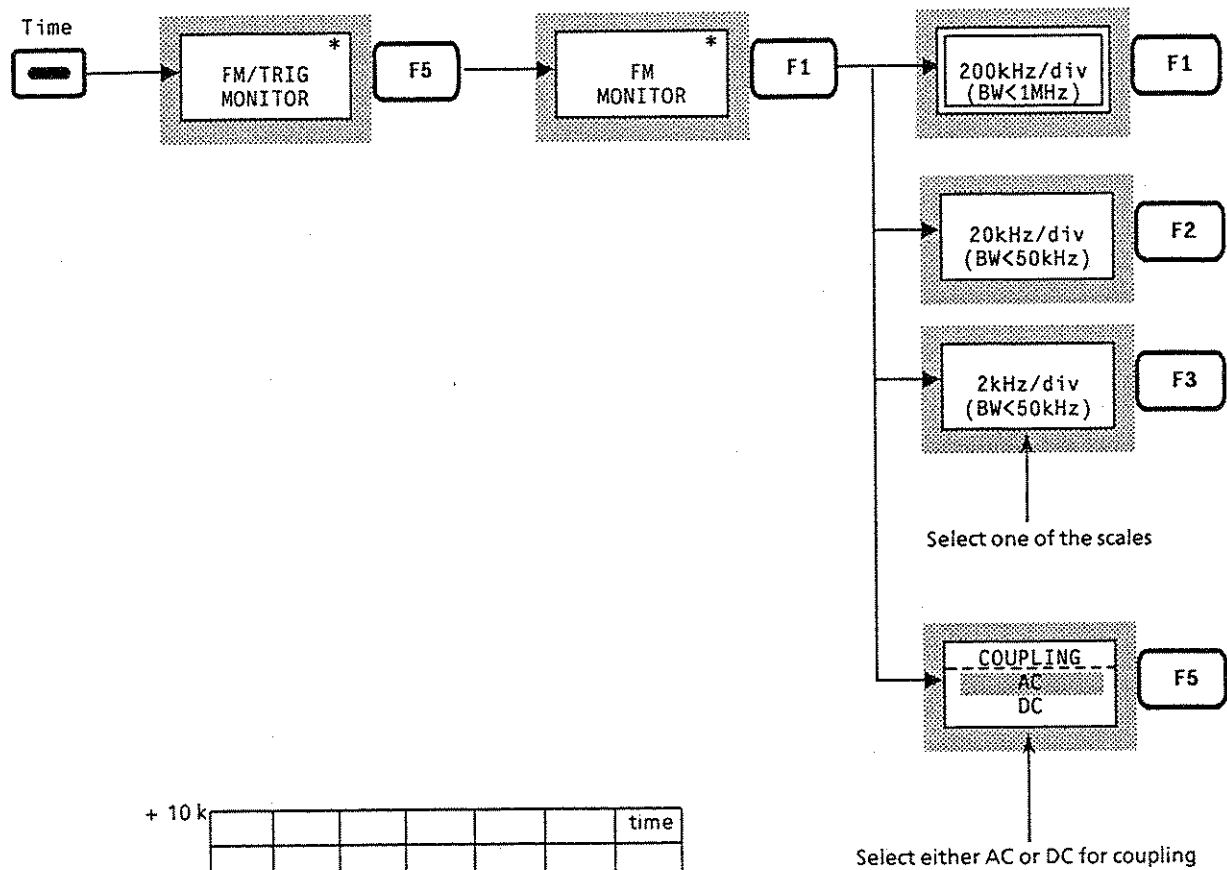

By using the FM demodulation waveform monitor function, the frequency deviation measurement can be easily performed. (See page 13-20.)

To monitor an FM demodulation waveform, set the resolution bandwidth and video bandwidth as follows:

- Resolution bandwidth (RBW) When a signal not accompanied by an interference wave has been received, the resolution bandwidth should be set as wide as possible. If it is necessary to narrow the resolution bandwidth, the bandwidth should be set to more than three times (frequency deviation + modulation frequency). Too narrow resolution bandwidth results in a distorted modulation waveform.
- Video bandwidth (VBW) The video bandwidth should be set as narrow as possible although a bandwidth of more than ten times the modulation frequency is required. Setting a wide video bandwidth causes S / N deterioration. If it is necessary to set wide bandwidth, digital averaging (see page 5-15) can be used to improve S/N.

Note: *Since the demodulation frequency range depends on the FM demodulation range, if the FM demodulation range is switched to the FM signal with high demodulation frequency, then a different waveform is observed.*

The demodulation frequency range corresponding to the respective FM demodulation ranges is as follows:

200 kHz / div range	DC or 50 Hz to 1 MHz
20 kHz / div range	DC or 50 Hz to 50 kHz
2 kHz / div range	DC or 50 Hz to 50 kHz

5.4.5 Monitoring external trigger signal

The MS2602A can display the waveform of an external trigger signal (signal input to the '1: Trig / Gate' connector in the Ext Input section on the rear panel).

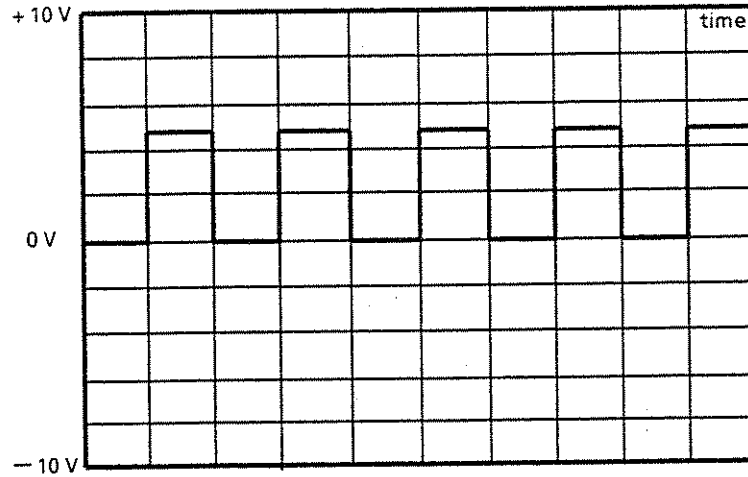
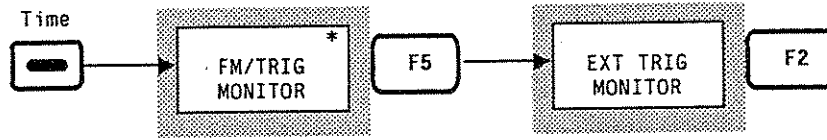

The external trigger signal waveform can be monitored without setting the resolution bandwidth and video bandwidth because the input signal from an external source enters A / D converter as it is.

(Blank)

SECTION 6

SELECTING SWEEP METHOD

This section describes not only the sweep method by the sweep mode and trigger, but also how to use the time gate analysis function for zone sweep, signal track, and burst wave analysis.

TABLE OF CONTENTS

6.1	Sweep Mode	6-3
6.1.1	Continuous sweep mode	6-3
6.1.2	Single sweep mode	6-4
6.1.3	Stopping the sweep	6-4
6.2	Trigger Mode	6-5
6.2.1	FREE RUN	6-5
6.2.2	TRIGGERED	6-6
6.2.3	Delay time	6-10
6.3	Zone Sweep and Signal Tracking	6-12
6.3.1	Zone sweep	6-12
6.3.2	Signal tracking	6-13
6.4	Analyzing Spectrum by Time Gate Analysis	6-14
6.4.1	Creating a gate control signal	6-17

(Blank)

SECTION 6 SELECTING SWEEP METHOD

6.1 Sweep Mode

The MS2602A sweep mode is set by using the keys in the Sweep Control section shown in the diagram below.

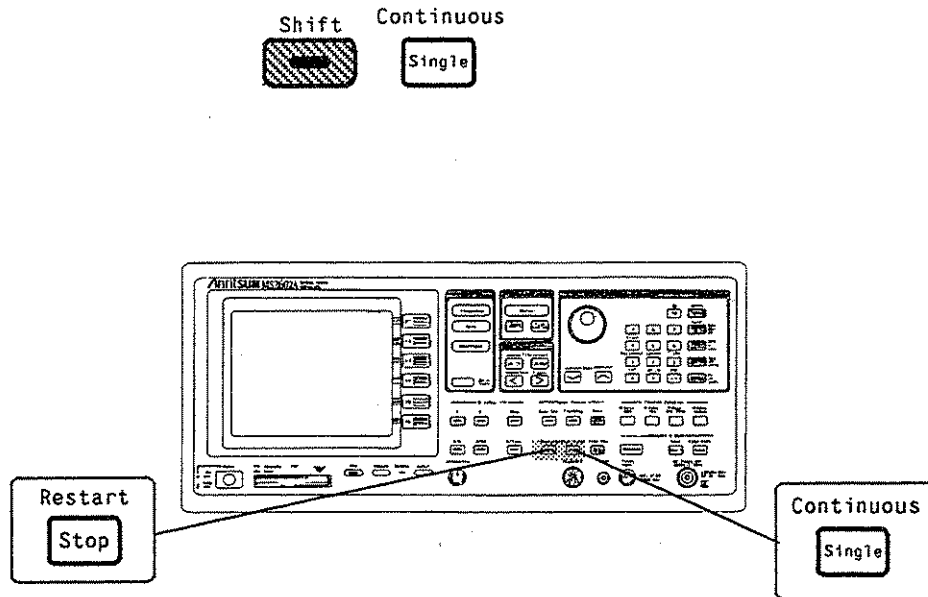

6.1.1 Continuous sweep mode

The MS2602A executes a continuous sweep with the trigger mode set to FREE RUN. When the trigger mode is set to TRIGGERED, the sweep is executed each time the trigger conditions are met.

To set the continuous sweep mode, perform the following key operations. (The continuous mode is initially set.)

6.1.2 Single sweep mode

When the trigger mode is set to FREE RUN, the sweep is executed only once immediately after the [Single] key is pressed.

When the trigger mode is set to TRIGGERED, the sweep is executed only once as long as the trigger conditions are met after the [Single] key is pressed.

To set single sweep mode or to execute a single sweep, press the [Single] key.



Continuous





When the single sweep mode is set, 'SGL SWP' is displayed at the upper right-hand corner of the screen.

6.1.3 Stopping the sweep

The sweep can be stopped independent of the current sweep condition or sweep stand-by condition. To stop the sweep in progress or to release the stopped sweep, perform the following key operations.

To stop the sweep in progress  

To release the stopped sweep   

While the sweep is not sweeping, 'STOPPED' is displayed at the upper right-hand corner of the screen.

When the sweep is restarted by pressing [Shift] [Stop] (Restart) in that order, the waveform data being displayed are all cleared to perform the new display. This allows data to be obtained from the beginning in storage mode.

6.2 Trigger Mode

The MS2602A trigger mode can be divided into FREE RUN and TRIGGERED. In TRIGGERED mode, VIDEO, LINE, EXT, or TV can be selected as the trigger source.

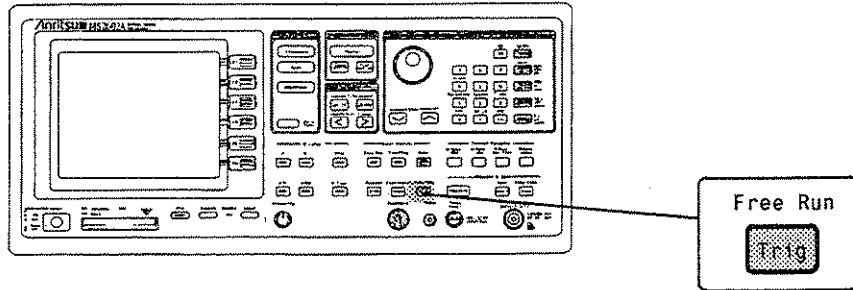

6.2.1 FREE RUN

When the sweep mode is set to continuous, the continuous sweep is executed repeatedly each time the trigger conditions are met.

The single sweep mode allows the single sweep to be started immediately after the [Single] key is pressed.

To set the FREE RUN mode, perform either of the following key operations. (The FREE RUN mode is initially set.)

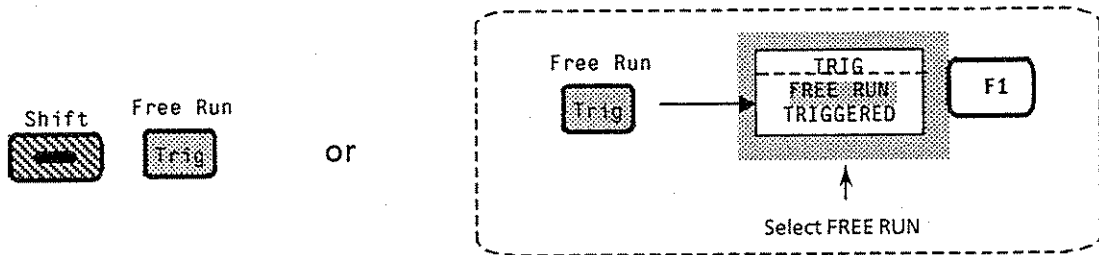

6.2.2 TRIGGERED

When the respective conditions of the pre-selected trigger source are met, the sweep can be started. To select TRIGGERED or trigger source, perform the following key operations.

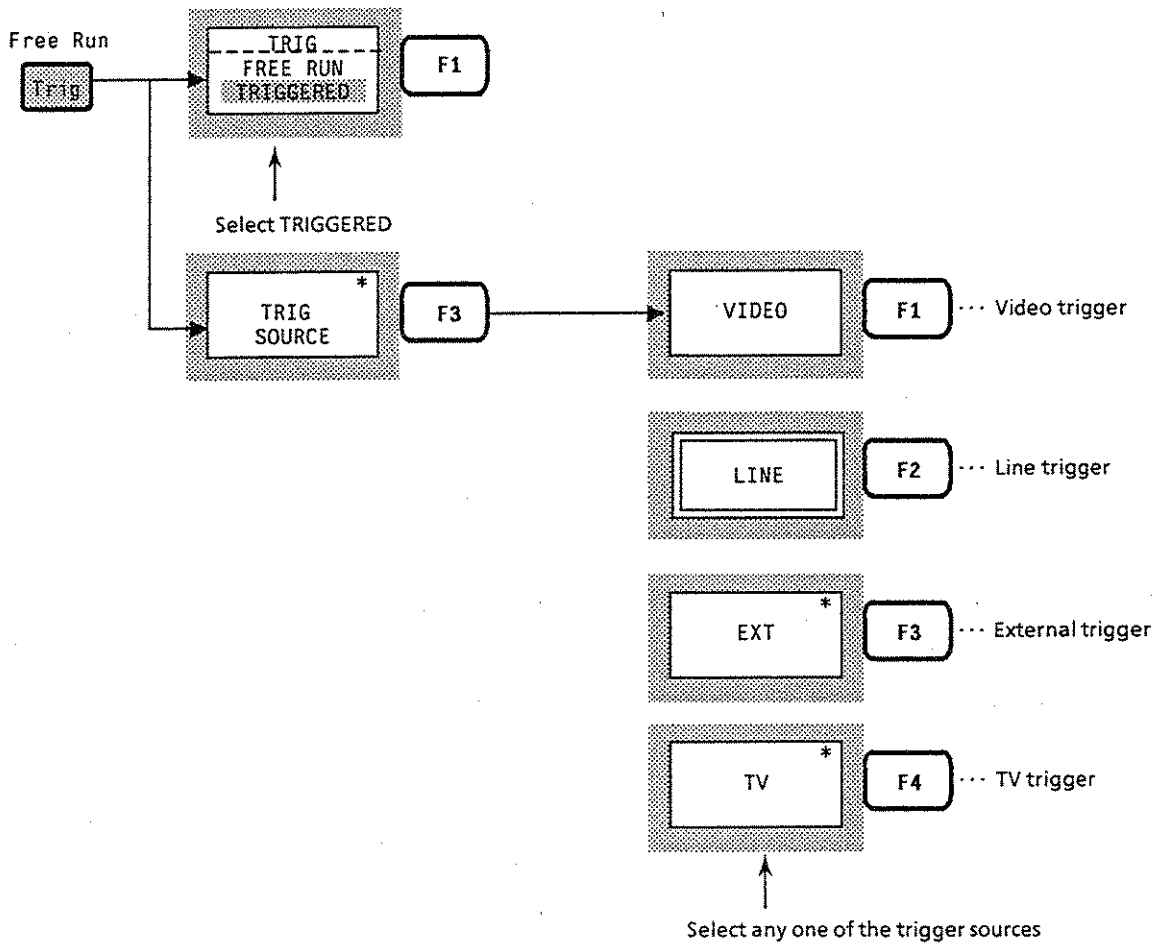

When the TRIGGERED mode is set, "TRIGGERED" is displayed at the upper right-hand corner of the screen.

(1) Video trigger

The sweep is started in synchronism with the positive leading edge or negative leading edge of the waveform after detection. Select the trigger level or trigger slope as follows:

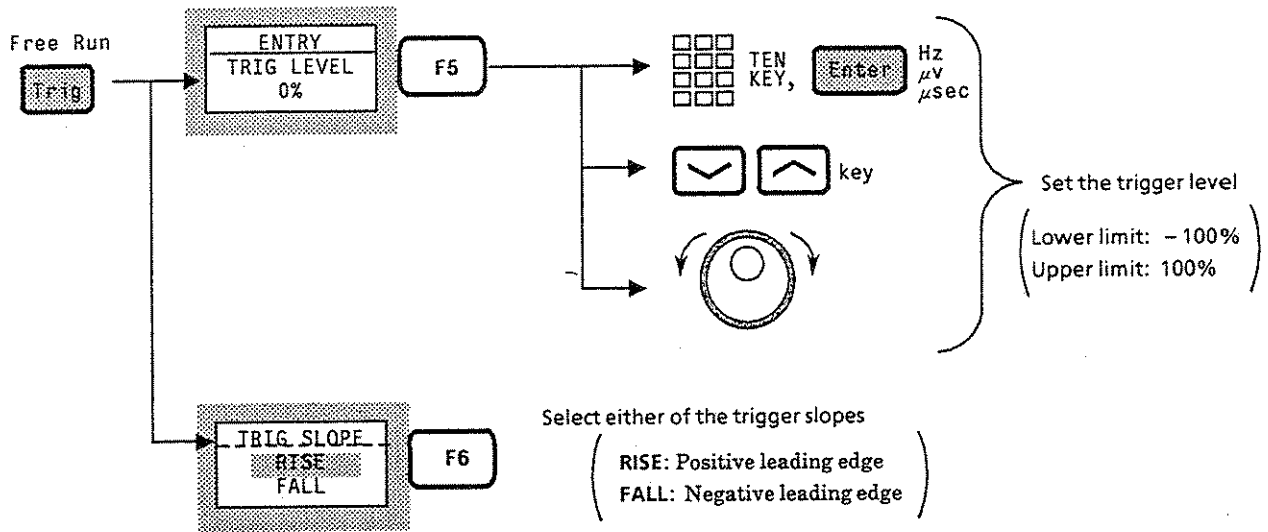

To set the trigger level, the trigger level indicator marked with ► is displayed along the leftmost vertical line of the screen.

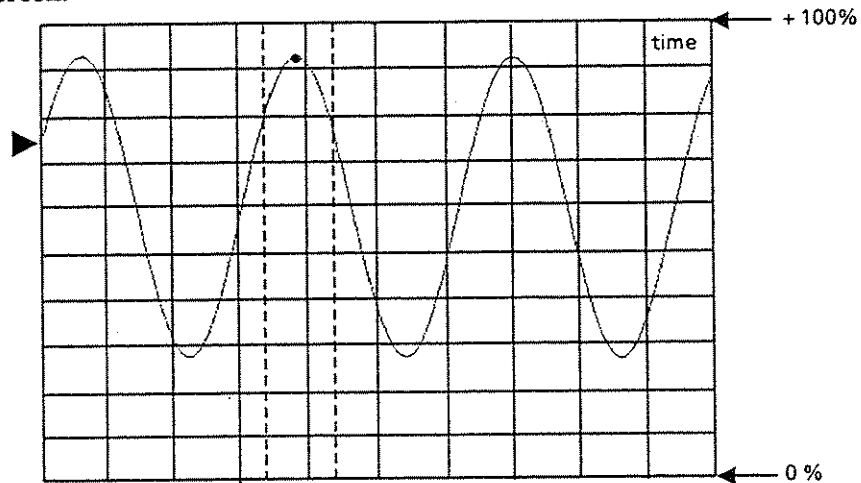

(2) Line trigger

The sweep is started in synchronism with the AC power line frequency. The line trigger is conveniently used to observe the power line-related hum waveform. The line trigger is used by selecting neither the trigger level nor trigger slope.

(3) External trigger

The sweep is started in synchronism with the positive leading edge or negative leading edge of the signal waveform input to the Ext Input connector on the rear panel. To select the Ext Input connector, trigger level, and trigger slope, perform the following key operations.

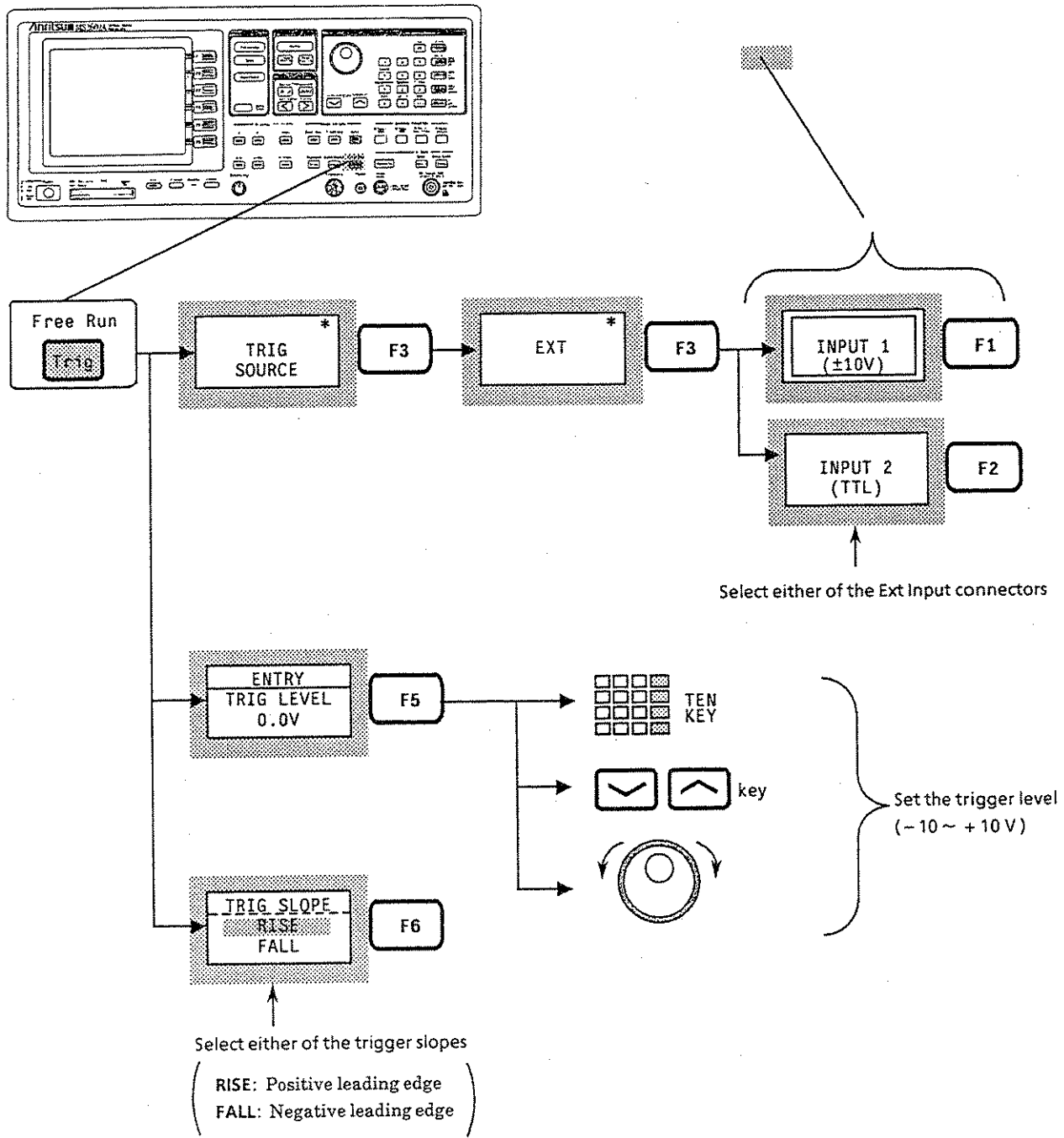

The trigger level is set incorrectly when the INPUT 2 (TTL) connector is selected. It is not necessary to set the trigger level.

(4) TV trigger

Selecting the TV trigger allows the horizontal or vertical synchronous signal to be detected to start the sweep.

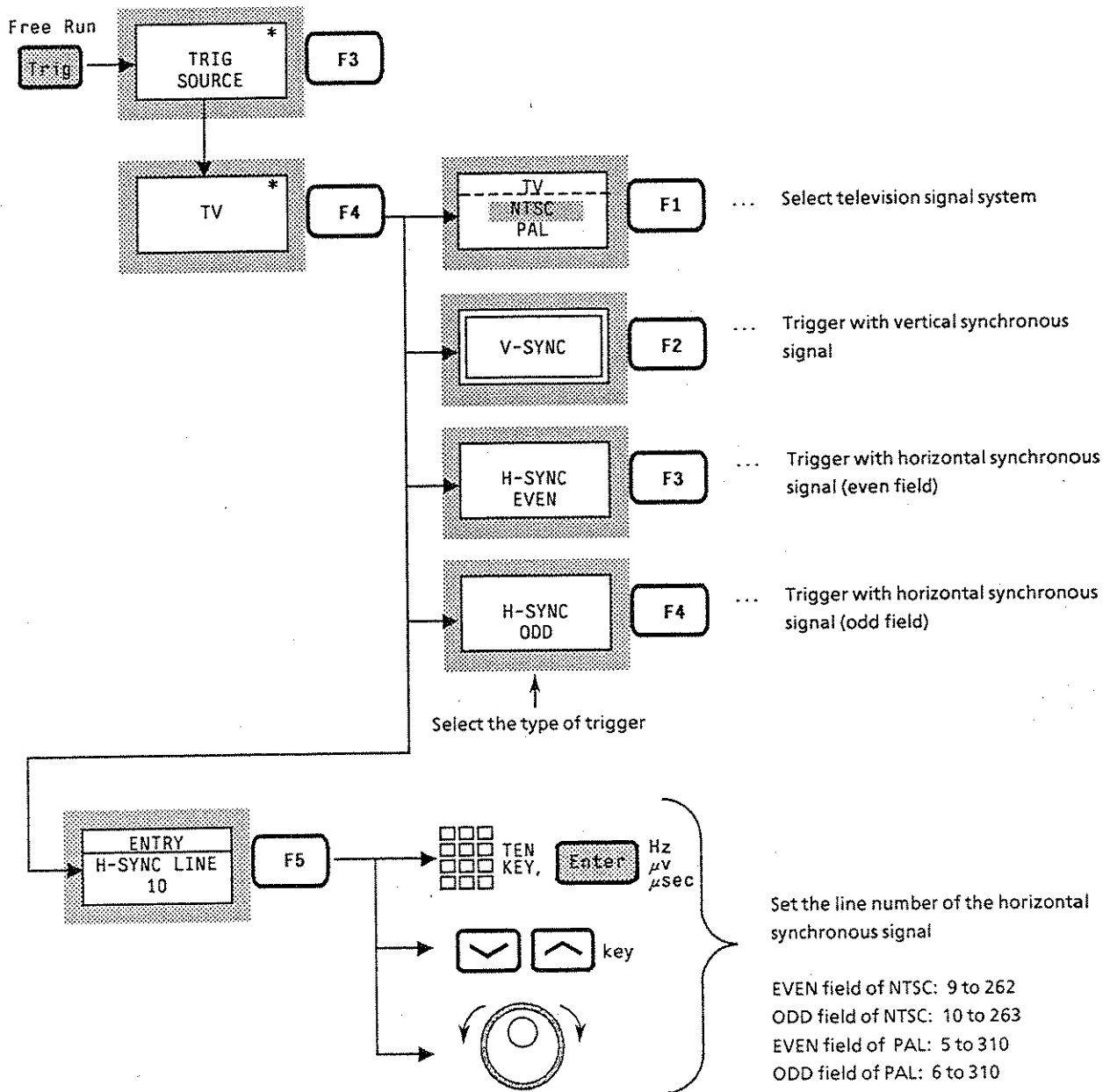

Note: TV trigger operates normally under the following conditions.

- Trace Time
- Linear scale
- The individual value of the resolution bandwidth (RBW) and video bandwidth (VBW) is 3 MHz.
- The peak level of the signal level exceeds 50% of the reference level.

6.2.3 Delay time

When the trigger mode is set to TRIGGERED in the time domain mode, the trigger point is usually positioned at the leftmost end of the screen. This, however, means that it is not possible to see the waveform before the trigger point and the waveform beyond the right end of the screen. The MS2602A can display the waveform away from the trigger point time by changing the delay time. To set the delay time, perform the following key operations.

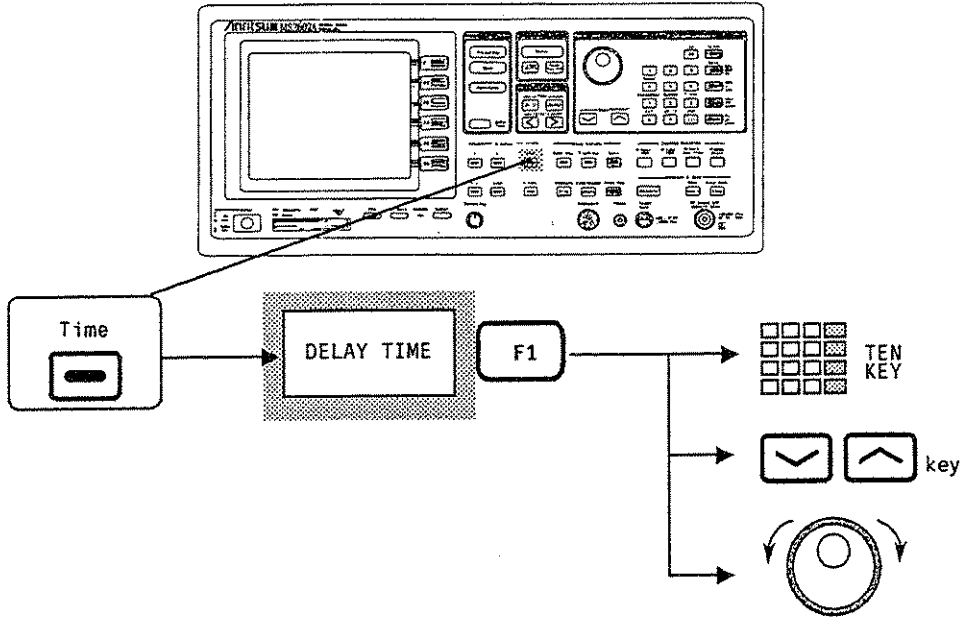

If the trigger point on the time axis on the screen was set by the delay time, the trigger level indicator marked with ▼ is displayed at the bottom of the screen.

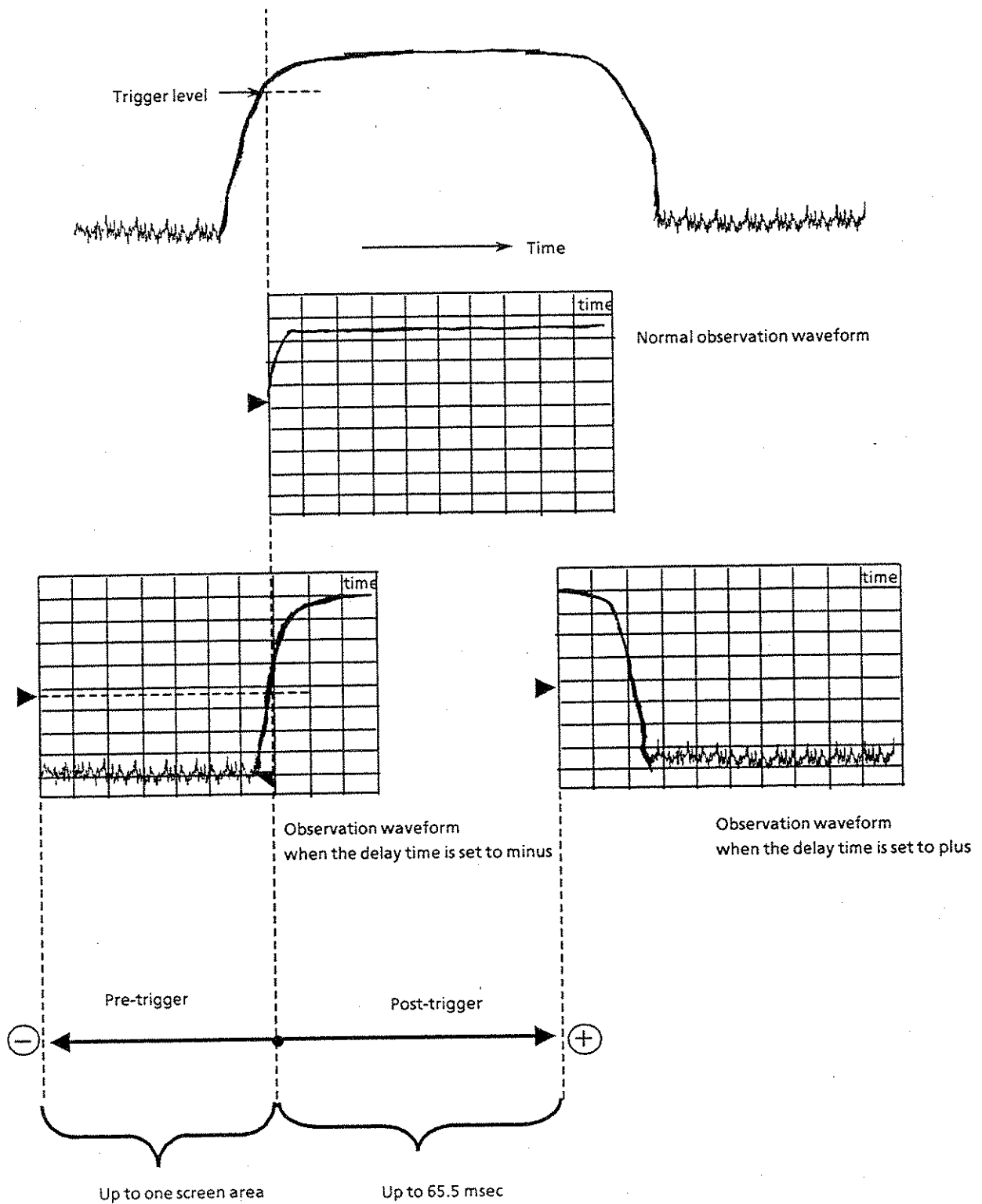

Example of Waveform With Delay Time (when used with video trigger)

6.3 Zone Sweep and Signal Tracking

The MS2602A has two special types of sweep method: one is the zone sweep which sweeps only within the zone marker, and the other is the signal tracking function which detects the peak level frequency at each sweep, then moves it to the center of the zone marker.

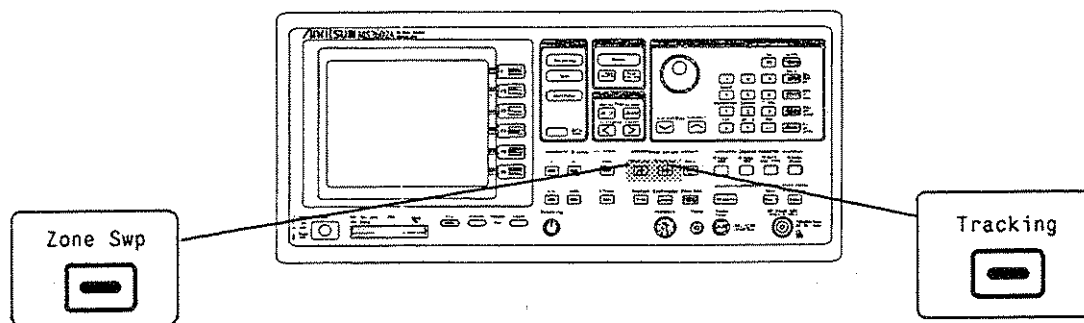

6.3.1 Zone sweep

When the [Zone Swp] key is pressed, the LED on top of the key remains lit orange. In this state, the zone sweep mode is set to only sweeps within the zone marker. Since this allows only part of the whole sweep range on the screen to be analyzed closely and quickly, the zone sweep can conveniently be used. To release the zone sweep function, press the [Zone Swp] key again.

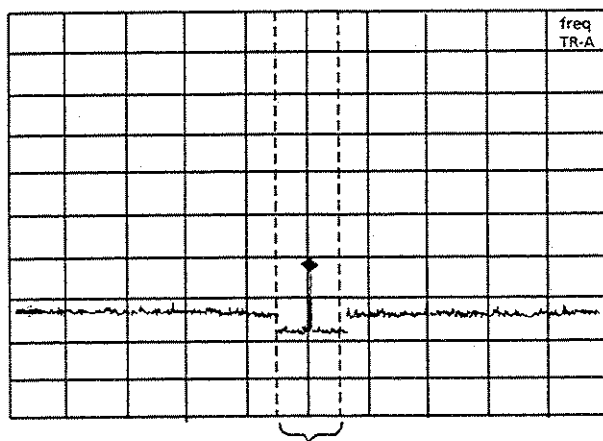

Set the zone sweep to ON, and a signal masked by noise can be analyzed at high speed by adjusting the resolution bandwidth and video bandwidth

Note: *The zone sweep cannot be executed during marker-OFF or time domain.*

6.3.2 Signal tracking

When the [Tracking] key is pressed, the LED on top of the key remains lit orange. In this state, the signal tracking function is set to ON. Since the signal frequency at the peak level within the zone marker can be moved to the center of the zone marker each time the sweep is repeated, the tracking function can conveniently be used to track and analyze a frequency-drifting signal.

To release the signal tracking function, press the [Tracking] key again.

Note: The tracking function cannot be executed during marker-OFF or domain.

6.4 Analyzing Spectrum by Time Gate Analysis

The time gate analysis function is a sweep mode which turns the waveform data display on and off by the gate control signal created in the MS2602A based on an external signal or video trigger signal. Since the timing to display a spectrum waveform can be set by using this mode, it is possible to analyze only the spectrum when the burst wave signal is set to ON.

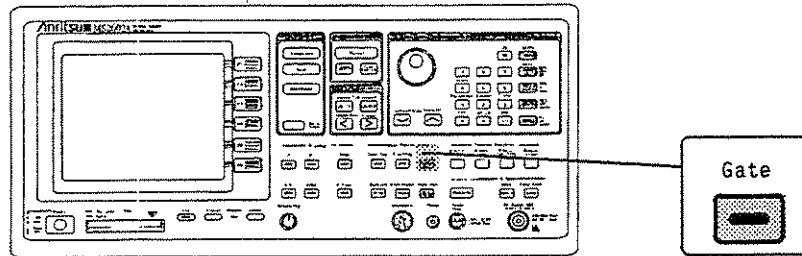

In order to use time gate analysis, an external trigger signal in synchronization with a signal transition from ON-OFF, and vice versa as a burst wave is required for creating the gate control signal. Although the video trigger signal can also be used, it is not recommended because of the limitations explained on Page 6-21.

If an external synchronous signal is unavailable, use the MA2511A Detector, which can create an external trigger signal by directly detecting the IF output signal from the MS2602A.

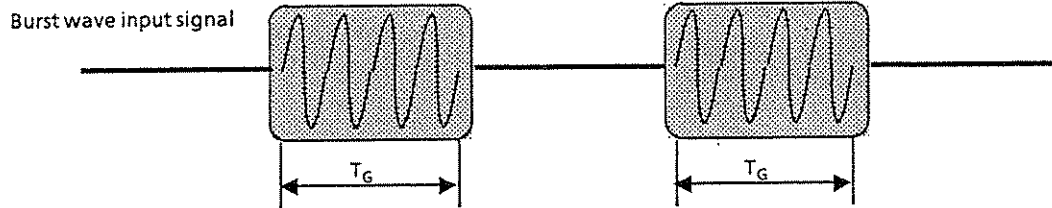

If the spectrum of the above burst wave is analyzed as it is,

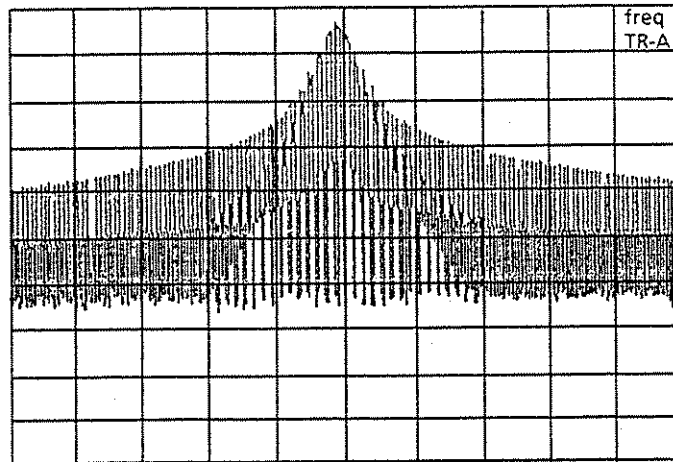

The spectrum spread by the positive leading edge or negative leading edge of the burst wave prevents the spectrum from being observed with the burst set to ON.

If the spectrum can be analyzed only during the gate time of T_G ,

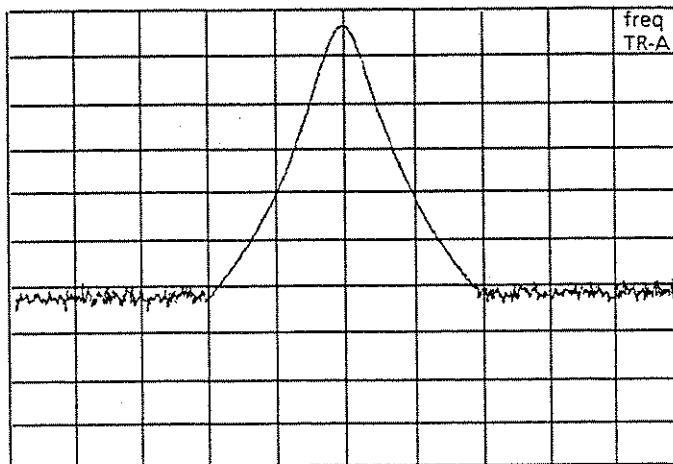

Only the spectrum when the burst is set to ON is displayed.

When the time gate analysis function is executed, the sweep runs in the FREE RUN mode and only the waveform data validated by the gate control signal is refreshed. If the sweep period is not synchronous with the gate control signal, a perfect-shaped trace can be obtained by increasing the number of sweep repetitions.

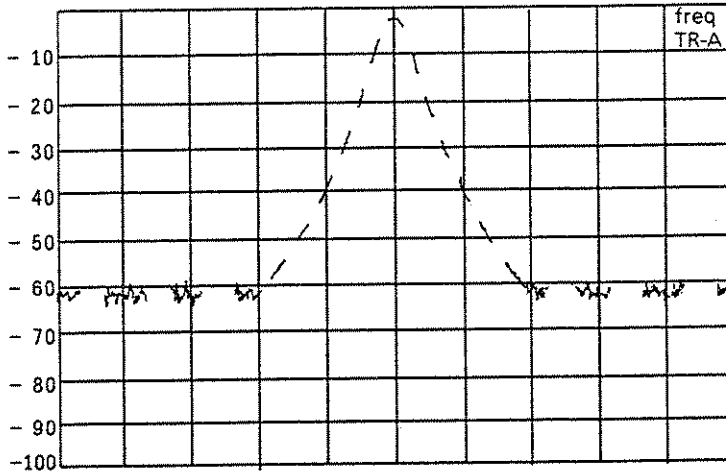

Fewer Sweep Repetitions

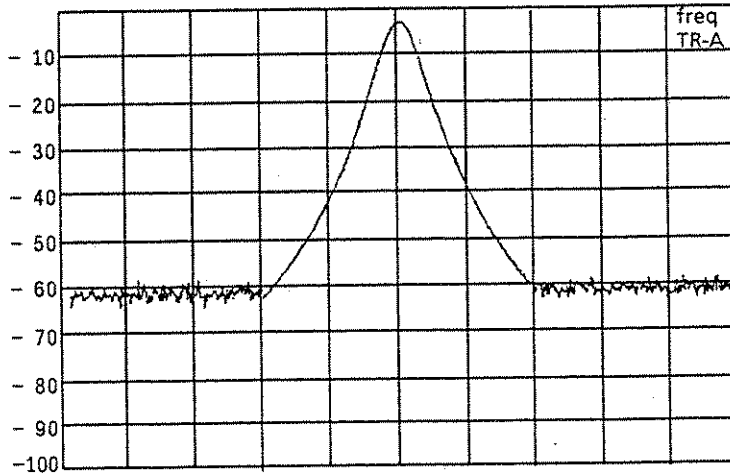

More Sweep Repetitions

Example of Frequency Spectrum Measurement on Burst Signal

6.4.1 Creating a gate control signal

If the point where an external trigger signal (only Ext Input 1) or a video trigger signal is triggered is assumed to be the reference position, the gate control signal remains ON over the period from the point immediately after the GATE DELAY time has elapsed from the reference position, to the time point set by the GATE LENGTH, or to the time reset by a trigger signal.

- GATE END: When INT is selected

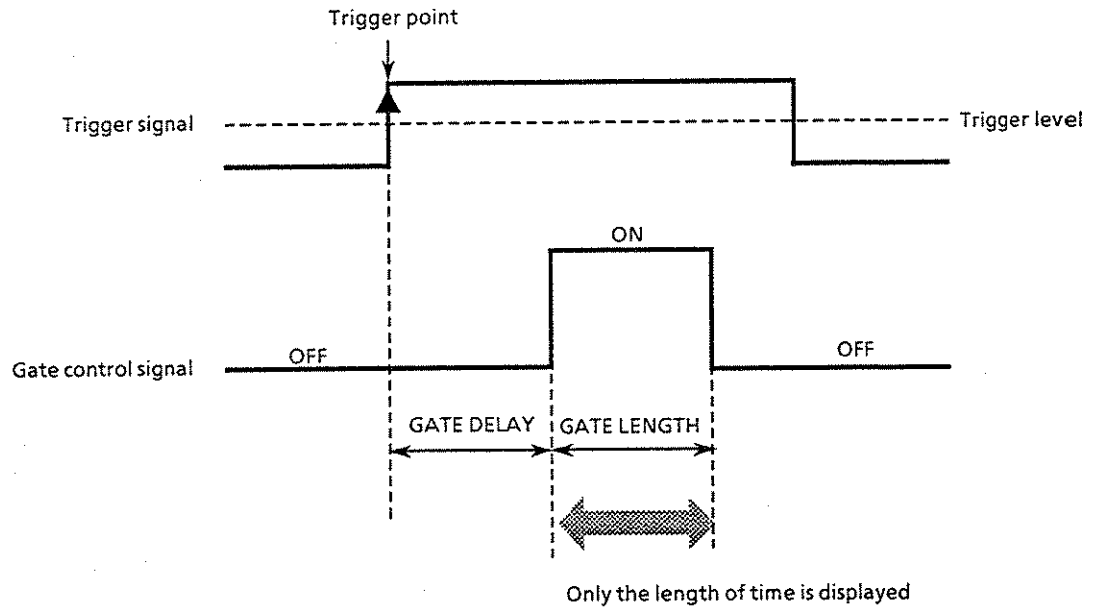

- GATE END: When EXT is selected

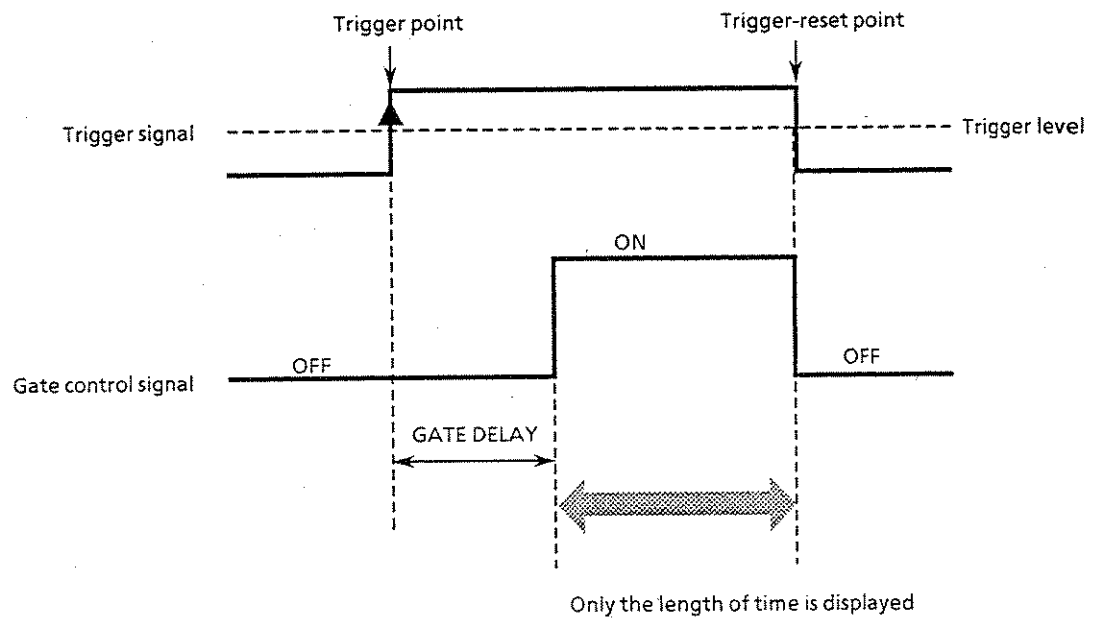

To set the time gate analysis function ON or OFF, and to create the gate control signal, perform the following key operations.

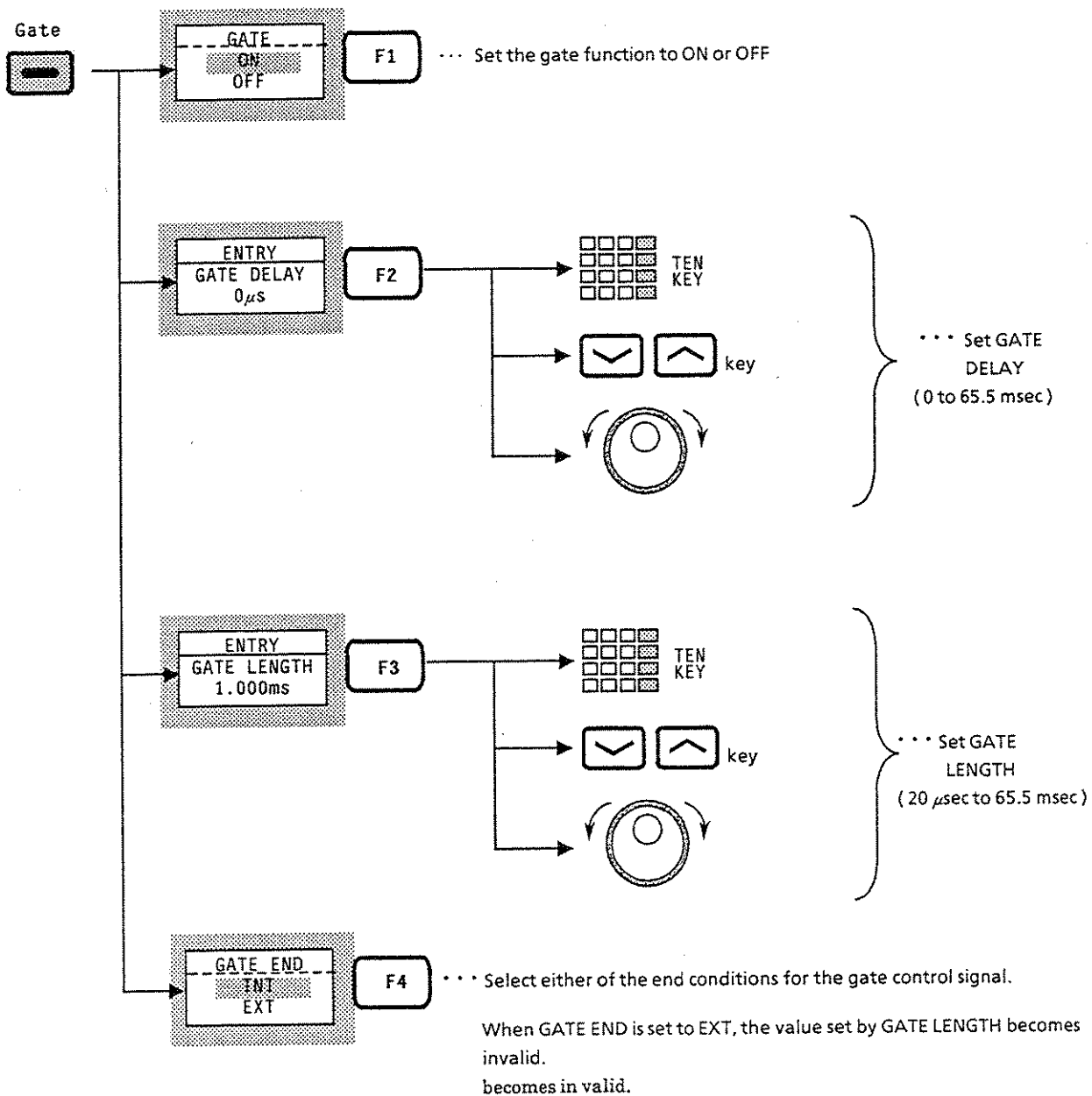

When the time gate analysis function is set to ON, the LED on top of the [Gate] key lights orange.

The time domain mode facilitates setting the time for the gate control signal. The following shows an example of how to use the time gate analysis function for which time domain is available.

Step	Procedure
------	-----------

- 1 Input the following signals to the MS2602A.

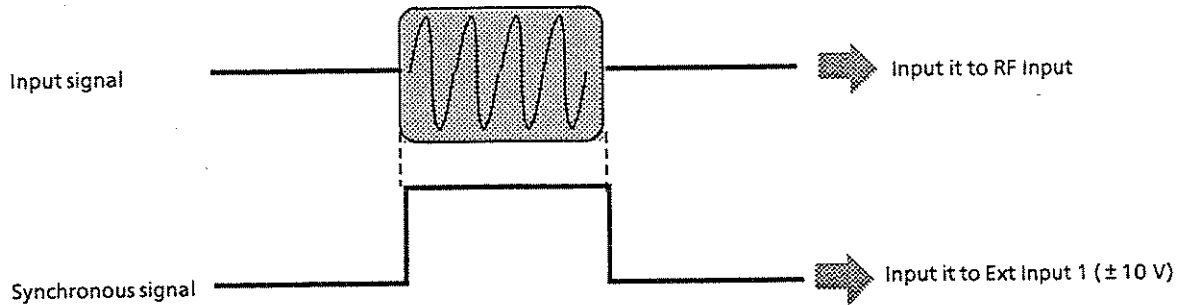

- 2 Display the waveform in the time domain mode. Synchronize the input signal by setting the trigger mode to TRIGGERED and the trigger source to EXT INPUT 1.

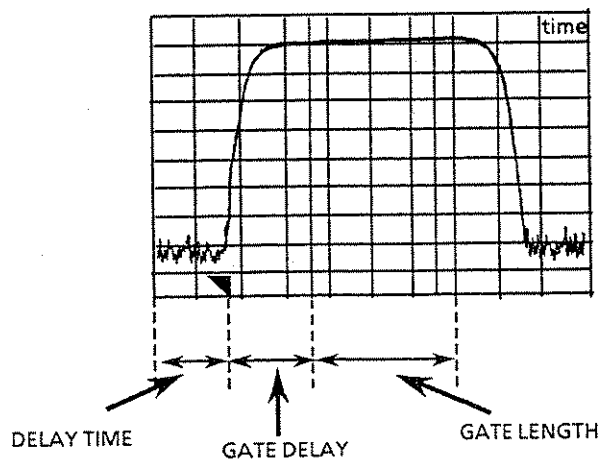

- 3 Set GATE to ON, and vertical lines (gate cursor) should be appear in the GATE DELAY and GATE LENGTH positions. Set GATE DELAY and GATE LENGTH to appropriate positions while observing the waveform.

At this time, adjust the resolution and video bandwidths in time domain mode to equal those in frequency domain mode, then set the gate cursor positions. It is possible to avoid the influence of spike-like noises independent of the conditions shown in Note 1 as described later.

- 4 Set the frequency domain, and the trigger mode runs in FREE RUN and the waveform data is displayed only for the time set by GATE LENGTH.

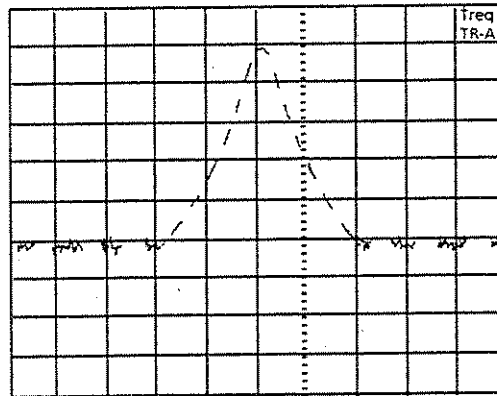

Notes: ① The detector output is delayed compared to the positive leading edge of the input waveform when the resolution bandwidth (RBW) is narrowed in frequency domain measurement mode. As a result, spike-like noises may appear on the trace. To prevent these from appearing, set GATE DELAY and GATE LENGTH to values that satisfy the following conditions..

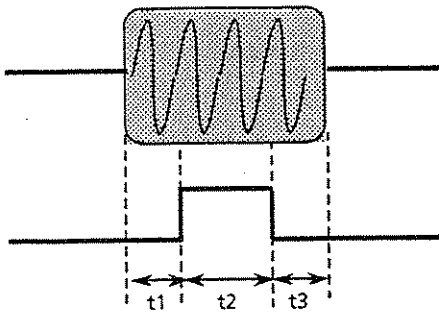

RBW	t1	t2	t3
1 kHz	≥ 2 msec	≥ 20 μ sec	≥ 1 μ sec
3 kHz	≥ 600 μ sec		
10 kHz	≥ 230 μ sec		
30 kHz	≥ 200 μ sec		
100 kHz	≥ 20 μ sec		
300 kHz	≥ 15 μ sec		
1 MHz 3 MHz	≥ 10 μ sec		

- ② When the resolution bandwidth (RBW) is extremely narrow for the frequency span, some waveforms cannot be displayed correctly. Set each parameter so that the following conditions are satisfied.

$$\text{RBW} \geq \frac{\text{SPAN}}{\text{Number of data points (501 or 1002)}} \times 5$$

- ③ *The Time Gate Analysis function can use a video trigger as a gate control signal. In this case, the gate control signal must be generated correctly so that a trigger can be normally set with the same RBW, VBW, and trigger level conditions at all frequencies within the frequency span observed in the frequency domain.*

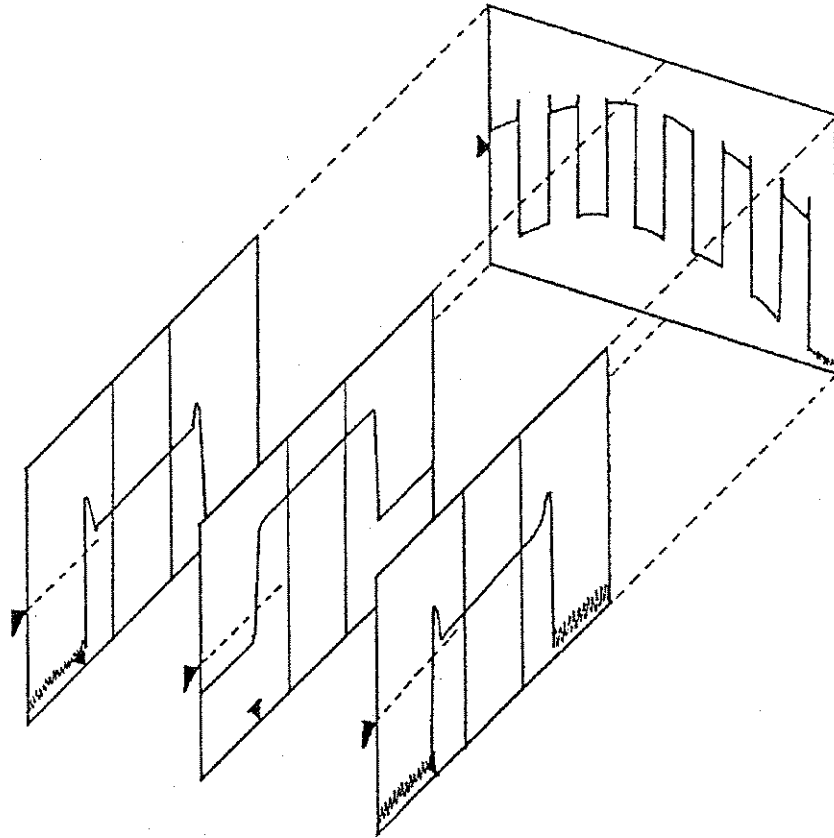

If the conditions described above are not satisfied, use of the MA2511A provides a method of setting a trigger by creating an external trigger signal based on the wide-band detection of the 521.4 MHz IF output from the MS2602A. For further details, refer to the MA2511A Detector Operation Manual.

(Blank)

SECTION 7

COUPLED FUNCTION

This section describes the coupled function group and its applications. Generally, the optimum values of the coupled function are automatically selected by the MS2602A itself so that both correct level and correct frequency values can be measured. This is called Auto Coupled Function. This section also describes the manual settings that are used to set the coupled function arbitrarily.

TABLE OF CONTENTS

7.1	Individual Coupled Functions	7-4
7.1.1	Resolution bandwidth / sweep time RBW / Swp Time	7-5
7.1.2	Video Bandwidth	VBW 7-8
7.1.3	Input attenuator	Atten 7-9
7.2	Coupled Mode	7-10

(Blank)

SECTION 7 COUPLED FUNCTION

The four functions of Resolution Bandwidth (RBW), Video Bandwidth (VBW), Sweep Time (Swp Time), and Attenuation (Atten) are initially all coupled and set individually to Auto. The optimum setting values of the coupled function are therefore automatically selected by the MS2602A itself. In the Auto Coupled Function mode, the individual Auto lamps above the respective setting keys in the Coupled Function section are lit green.

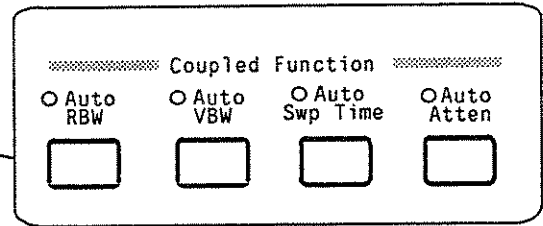
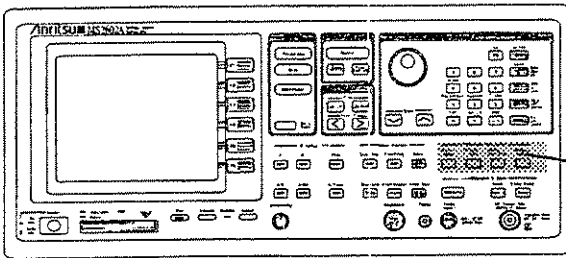

Changing from Auto to Manual

- To set RBW to Manual → RBW
- To set VBW to Manual → VBW
- To set Swp Time to Manual → Swp Time
- To set Atten to Manual → Atten

Changing from Manual to Auto control

- To set RBW to Auto → RBW → AUTO (F2)
- To set VBW to Auto → VBW → AUTO (F2)
- To set Swp Time to Auto → Swp Time → AUTO (F2)
- To set Atten to Auto → Atten → AUTO (F2)
- To set all except Atten to Auto → RBW, VBW, Swp Time → RB, VB, SWT AUTO (F5)
- To set all coupled functions to Auto → RBW, VBW, Swp Time, Atten → ALL AUTO (F6)

7.1 Individual Coupled Functions

When set manually as shows below, the individual Auto lamps above the respective setting keys go out.

<input type="radio"/> Auto RBW <input type="text"/>	When this key is pressed, the current RBW value is displayed in the communication field. Enter the required value by using the TEN keys, [∇][^] keys, or rotary knob.
<input type="radio"/> Auto VBW <input type="text"/>	When this key is pressed, the current VBW value is displayed in the communication field. Enter the required value by using the TEN keys, [∇][^] keys, or rotary knob.
<input type="radio"/> Auto Swp Time <input type="text"/>	When this key is pressed, the current Sweep Time value is displayed in the communication field. Enter the required value by using the TEN keys, [∇][^] keys, or rotary knob.
<input type="radio"/> Auto Atten <input type="text"/>	When this key is pressed, the current Attenuation value is displayed in the communication field. Enter the required value by using the TEN keys, [∇][^] keys, or rotary knob.

In the manual setting mode, the “#” mark appears at the end of each individual coupled function display on the screen.

RB 1 MHz → RB 1 MHz#
VB 100 kHz → VB 100 kHz#
ST 200 msec → ST 200 msec#
AT 5 dB → AT 5 dB#

7.1.1 Resolution bandwidth / sweep time RBW / Swp Time

(1) Auto mode

The RBW, Swp Time, and VBW parameters are set to Auto so that even if the frequency span is varied, the respective parameters are automatically set to the optimum values so that frequency and level measurement errors do not occur.

The table below shows how the frequency span, RBW, VBW, and Swp Time parameters are calculated in Auto mode.

Frequency span (Hz)	RBW (Hz)	VBW (Hz)	Swp Time (sec)
100 ~ 150	10	$VBW = R \times RBW$ Where, the lower limit is 1 Hz, and the upper limit is 3 MHz R:FREQ-VB/RB RATIO Setting value (0.0001 to 100) (Initial setting: 1)	If $RBW < VBW$, then $Swp\ Time = K \times \frac{SPAN}{RBW^2}$ If $RBW > VBW$, then $Swp\ Time = K \times \frac{SPAN}{RBW \times VBW}$ K=3 (AUTO SWT: for NORMAL) K=2 (AUTO SWT: for FAST) (when the system is set)
151 ~ 1 k	30		
1.01 k ~ 10 k	100		
10.1 k ~ 20 k	300		
20.1 k ~ 100 k	1 k		
101 k ~ 200 k	3 k		
201 k ~ 2 M	10 k		
2.01 M ~ 20 M	30 k		
20.1 M ~ 200 M	100 k		
201 M ~ 1 G	300 k		
1.01 G ~ 8.5 G	1 M		

- When RBW is Auto, the RBW value depends on the frequency span.
- When VBW is Auto, the VBW value depends on the values of RBW and FREQ – VB / RB RATIO. For details of FREQ – VB / RB RATIO, see page 7-8.
- When Swp Time is Auto, the Swp Time value depends on the values of frequency span, RBW, VBW, and AUTO SWT modes. For details of AUTO SWT mode, see SECTION 9, MEASUREMENT SYSTEM SETTING (page 9-3).

The setting range at Swp Time Auto is as follows:

- Lower limit value

For band 0 only: 20 msec (data point at trace A or trace B: when set to 501)
50 msec (data point at simultaneous display of trace A and trace B:
when set to 501)
50 msec (data point: when set to 1002)

For band 1⁻ or 1⁺: 100 msec (SPAN \leq 3 GHz)
200 msec (SPAN > 3GHz)

- Upper limit value

1000 sec

(2) Manual setting

Provided RBW, VBW, and Swp Time are set to Auto mode, normal measurements can be made without considering these setting. In the following cases, RBW should be set to manual mode.

- ① **General measurements:** When observing two adjacent signals, increasing the frequency resolution by narrowing RBW can reduce the noise level (a tenth part of the current RBW results in 10 dB reduction). However, if it is too narrow, the spectrum waveforms become too steep, the response characteristics become worse, and the sweep time also becomes longer. Therefore, the RBW value should be determined to give a practical sweep speed.
- ② **Intermodulation distortion measurement:** When measuring two signal intermodulation distortion with a comparatively wide frequency span and a reduced noise level, the RBW value should be narrowed by manual setting. However, the sweep time increases in inverse proportion to the square of RBW.

The bandwidths that can be selected by Manual are 10 Hz, 30 Hz, 100 Hz, 300 Hz, 1 kHz, 3 kHz, 10 kHz, 30kHz, 100 kHz, 300kHz, 1 MHz, and 3 MHz.

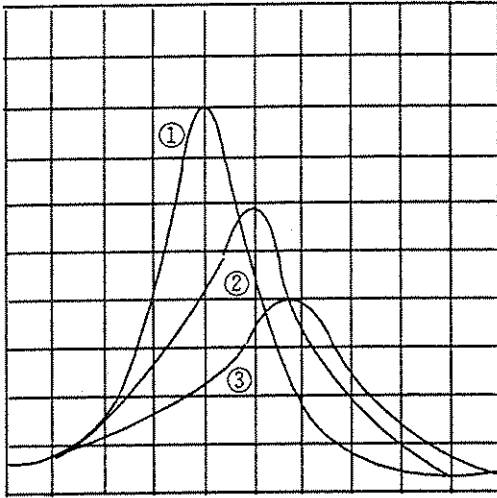

Note: The spectrum traces on the screen are displayed as shown on the left diagram according to the sweep time. The optimum sweep time gives a waveform like ①. However, a too fast sweep time decreases the waveform amplitude on the display as shown in ② and ③. Therefore, the apparent bandwidth gets wider, and the frequency also shifts. When the proper waveform ① cannot be maintained, "UNCAL" is displayed at the top-right-hand corner of the graticule on the screen.

The sweep time setting range depends on the DISPLAY mode and data point value.

Trace A or Trace B	20 msec to 1000 sec (data point: when set to 501) 50 msec to 1000 sec (data point: when set to 1002)
Simultaneous display of trace A and trace B ...	50 msec to 1000 sec (independent of data point)

7.1.2 Video Bandwidth VBW

(1) AUTO mode

As shown in the table on page 7-5, the VBW value is set to (FREQ - VB / RB RATIO) multiplied by RBW when VBW is set to Auto. Initially, since the (FREQ - VB / RB RATIO) becomes 1, both RBW and VBW are set to the same value. The setting range (FREQ - VB / RB RATIO) is from 0.0001 to 100. Set the data as follows.

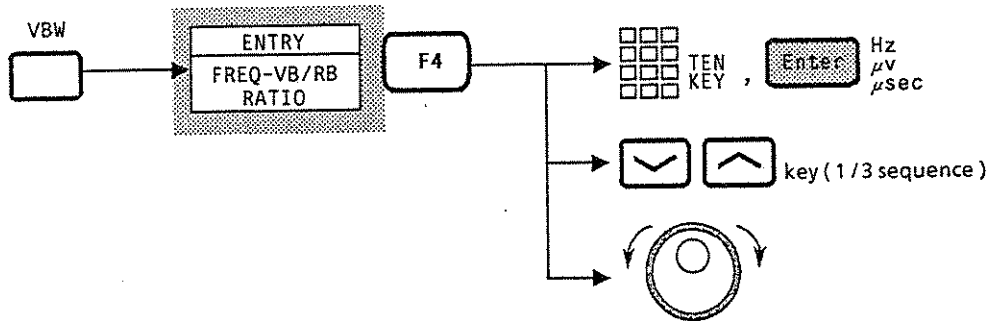

By setting (FREQ - VB / RB RATIO) to a small value, since VBW is set to a narrow value according to the RBW setting, it is possible to average noise efficiently.

Note: Since the setting range for VBW is from 1 Hz to 3 MHz, if an attempt is made to exceed this range, the VBW value is set to 1 Hz or 3 MHz.

(2) Manual setting

When a narrow VBW is required to average the noise response independent of RBW, or when a wider VBW is required to observe a signal waveform modulated with a high frequency, it is recommended that the VBW value be set to manual.

The bandwidths that can be selected manually are 1 Hz, 3 Hz, 10 Hz, 30 Hz, 100 Hz, 300 Hz, 1 kHz, 3 kHz, 10 kHz, 30 kHz, 100 kHz, 300 kHz, 1MHz, 3MHz, and OFF.

To set VBW to OFF, perform the following key operation.

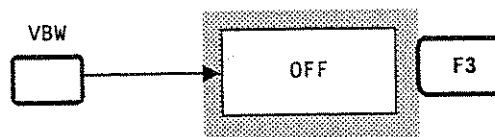

Notes: • The setting conditions of $VBW \geq RBW$ not only averages the noise response, but also increases the sweep time.

• The video averaging performed without narrowing the VBW (without decreasing the sweep time) can also average the noise response. For further details, see page 5-15.

7.1.3 Input attenuator Atten

(1) Auto mode

When the reference level is set while Auto is selected, the input attenuator is automatically set according to the AUTO column to give a wider dynamic range without gain compression according to the reference level.

Reference Level and Input Attenuator

REF LEVEL (dBm)	AUTO Atten (dB)
+25.1 to +30.0	45
+20.1 to +25.0	40
+15.1 to +20.0	35
+10.1 to +15.0	30
+5.1 to +10.0	25
+0.1 to +5.0	20
-4.9 to 0.0	15
-9.9 to -5.0	10
-74.9 to -10.0	5
-100.0 to -75.0	0

REF LEVEL (dBm)	MANUAL Atten (dB) *
+25.1 to +30.0	40 to 55
+20.1 to +25.0	35 to 55
+15.1 to +20.0	30 to 55
+10.1 to +15.0	25 to 55
+5.1 to +10.0	20 to 55
+0.1 to +5.0	15 to 55
-4.9 to 0.0	10 to 55
-9.9 to -5.0	5 to 55
-45.0 to -10.0	0 to 55
-50.0 to -45.1	0 to 50
-55.0 to -50.1	0 to 45
-60.0 to -55.1	0 to 40
-65.0 to -60.1	0 to 35
-70.0 to -65.1	0 to 30
-75.0 to -70.1	0 to 25
-80.0 to -75.1	0 to 20
-85.0 to -80.1	0 to 15
-90.0 to -85.1	0 to 10
-95.0 to -90.1	0 to 5
-100.0 to -95.1	0

* The resolution value for setting input attenuator is 5 dB.

(2) Manual setting

When a signal with the same level as the reference level is input, the input attenuator value in Auto mode is controlled so that high accuracy measurement can be performed without being influenced by gain compression and the noise level can be reduced. However, when a weaker signal measurement is required by increasing the sensitivity as when measuring a signal containing spurious non-harmonics and adjacent signals, it may be impossible to measure because the Atten values in Auto mode are too large. In this case, set the input attenuator manually according to the table in paragraph (1).

As long as the mixer level = { (same input level as reference level) - (input attenuator setting value) } is -10 dBm or less, a smaller input attenuator value can be set.

For the second and third harmonic measurements, it is necessary to eliminate the influence of internal distortion by decreasing the mixer input level. The internal distortion is specified as -80 dB when the mixer input level is -40 dBm. If the measurement range of spurious harmonics is required to be -80 dB, the mixer input level must be set to -40 dBm or less. In this case, set the input attenuator manually because the Atten values in Auto mode are too small.

7.2 Coupled Mode

At factory shipment, the four coupled functions of RBW, VBW, Swp Time (Time Span), and Atten are specified as the same values between frequency domain and time domain. This gives the same operation as the zero span of a traditional spectrum analyzer. Where parameters are set actually between frequency domain and time domain, to set the RBW, VBW, Swp Time (Time Span) parameters to different values, perform the following System settings.

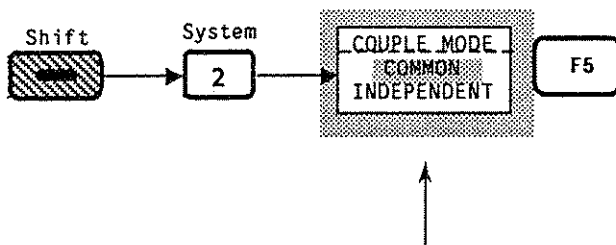

COMMON: The same values are set for both frequency domain and time domain
INDEPENDENT: Different values are set between frequency domain and time domain

It is impossible to set the Atten value independently. When COUPLE MODE is set to INDEPENDENT while in time domain mode, "RB" and "VB" displayed at the top of the screen are changed to "RBt" and "VBt" respectively.

Note: The coupled mode settings remain unchanged even when set to initial.

SECTION 8

AUTOMATIC CALIBRATION AND PRESELECTOR TUNING

This section describes the internal auto calibration function which minimizes the measurement error of the MS2602A, and the preselector tuning which passes the 1.7 GHz or higher frequencies.

TABLE OF CONTENTS

8.1	Automatic Calibration Function	CAL	8-3
8.1.1	Calibration items		8-5
8.2	Preselector Tuning		8-6
8.3	Measurement System Correction		8-8

(Blank)

SECTION 8

AUTOMATIC CALIBRATION AND PRESELECTOR TUNING

8.1 Automatic Calibration Function CAL

WARNING

If calibration is executed with an external signal applied to RF Input, it is impossible to obtain the correct calibration value. Perform calibration without applying any signal to the RF Input connector.

The MS2602A incorporates a 625 kHz Calibration Oscillator and a Calibration Attenuator, which perform automatic calibration so that the MS2602A can minimize measurement errors and gives high accuracy measurements.

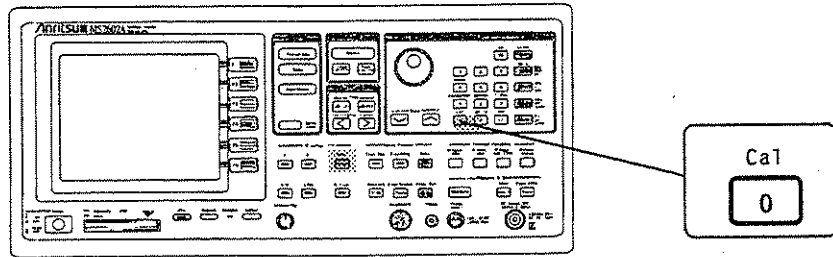

Press the [Shift] key then the [Cal] key, and the CAL menu for automatic calibration is displayed. Pushing the [F1] to [F3] keys executes automatic calibration. Perform the following key operation for automatic calibration.

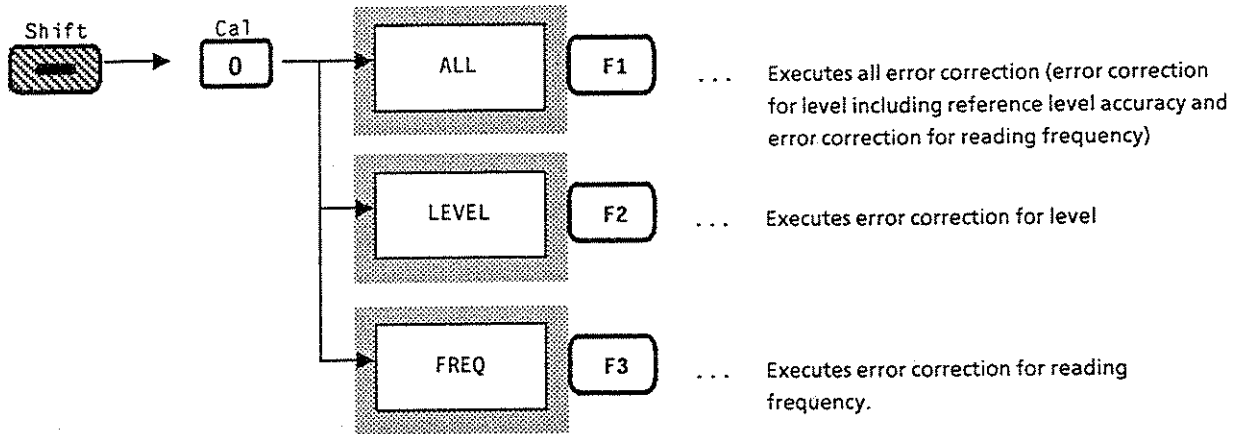

While automatic calibration is being executed, a clock indicating the elapsed calibration time is displayed instead of the normal display screen. When the needle of the clock reaches the 12 o'clock position, calibration is completed.

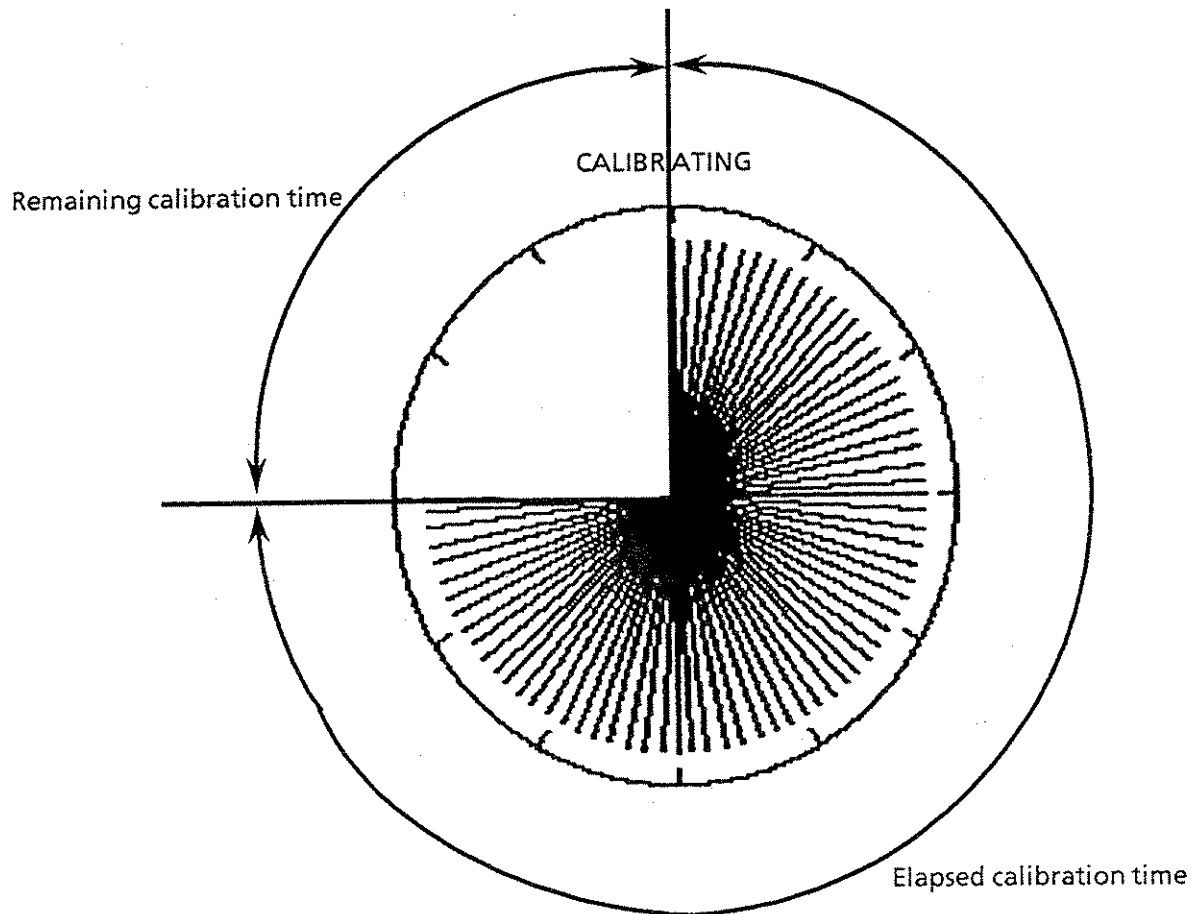

8.1.1 Calibration items

The calibration items in the table below are divided into those calibrated by the automatic calibration function and those calibrated at the factory.

ALL CAL	LEVEL CAL	Reference level error calibration	Calibrates absolute-value levels on LOG / LIN scale
		LOG-scale linearity calibration	Calibrates LOG-scale linearity
		IF Gain switching error correction	Calibrates the error caused by the IF Gain from the level errors when reference level is switched
		RBW switching error calibration	Calibrates level error when resolution bandwidth (RBW) is switched
		Detection-mode switching error calibration	Calibrates level error when detection mode (POS PEAK, SAMPLE, NEG PEAK) is switched
	FREQ CAL	RBW center frequency calibration	Calibrates center frequency error when resolution bandwidth (RBW) is switched
		FM detector linearity calibration	Calibrates FM detector linearity for monitoring FM demodulation waveform
		RBW bandwidth measurement	Performs RBW bandwidth measurement used for the bandwidth conversion of noise measurement
Calibration at factory	Frequency response calibration	Calibrates amplitude frequency response over the entire band	
	Input-attenuator switching error calibration	Calibrates level error when input attenuator is switched	

When ALL CAL is executed, the calibration data is retained by the built-in battery back-up even when the MS2602A power is turned off. Therefore, it is not always necessary to execute automatic calibration each time the power is turned on. However, when a particularly high accuracy measurement is required, when the specifications are not met, or when the set-up circumstances have changed greatly (such as ambient temperature), execute automatic calibration again.

Notes: • *Since the built-in calibration oscillator is automatically connected internally when automatic calibration is executed, external connection is not required.*

- *Unless the frequency span is taken into consideration, the measurement frequency error depends on the local oscillator frequency error and the IF center frequency error. The local oscillator of the MS2602A operates on the synthesizer system and its frequency error depends on the frequency accuracy of the reference crystal oscillator or external reference signal input. The frequency-related automatic calibration calibrates the IF center frequency error.*

8.2 Preselector Tuning

Since the MS2602A is a spectrum analyzer operating on the super heterodyne system, undesired responses such as image response, multiple response, and others could appear on the screen. The MS2602A therefore uses a preselector only for the true signal to appear on the screen by eliminating these undesired responses. The preselector is a variable tuning-type band-pass filter in which a receiving frequency can be tracked. Since the MS2602A uses the preselector in both the 1^- band (1.7 to 7.5 GHz) and 1^+ band (6.5 to 8.5 GHz), the way of tuning (peaking) is explained in this paragraph.

In normal use, it is unnecessary to perform peaking as long as the bias value is not shifted intentionally because the peaking-bias initial value is set at each frequency.

When it deviates from the proper bias, the receiving level becomes smaller as shown in the lower-left diagram; therefore, perform peaking so that the maximum amplitude response can be obtained as shown in the lower-right diagram.

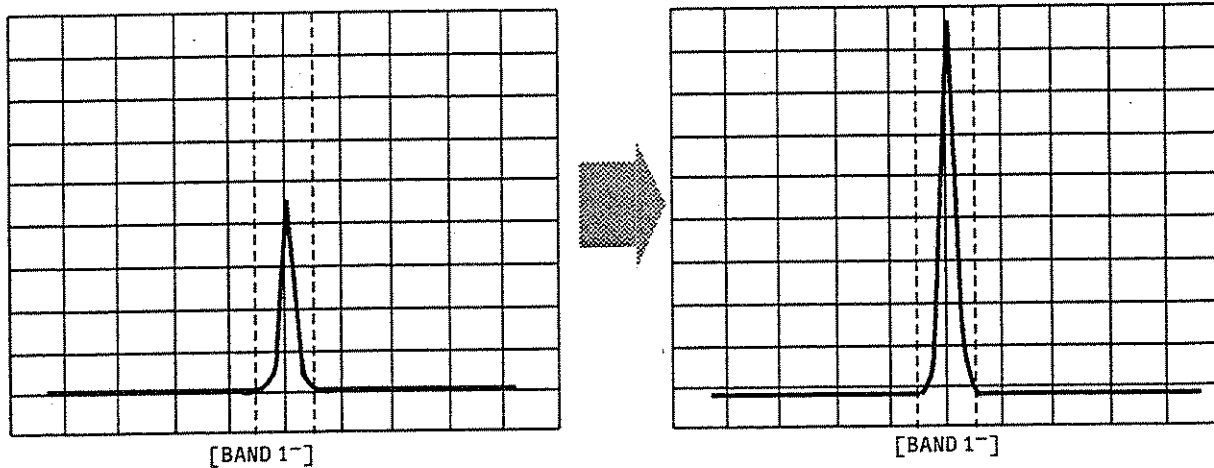

To execute peaking, perform the following key operation.

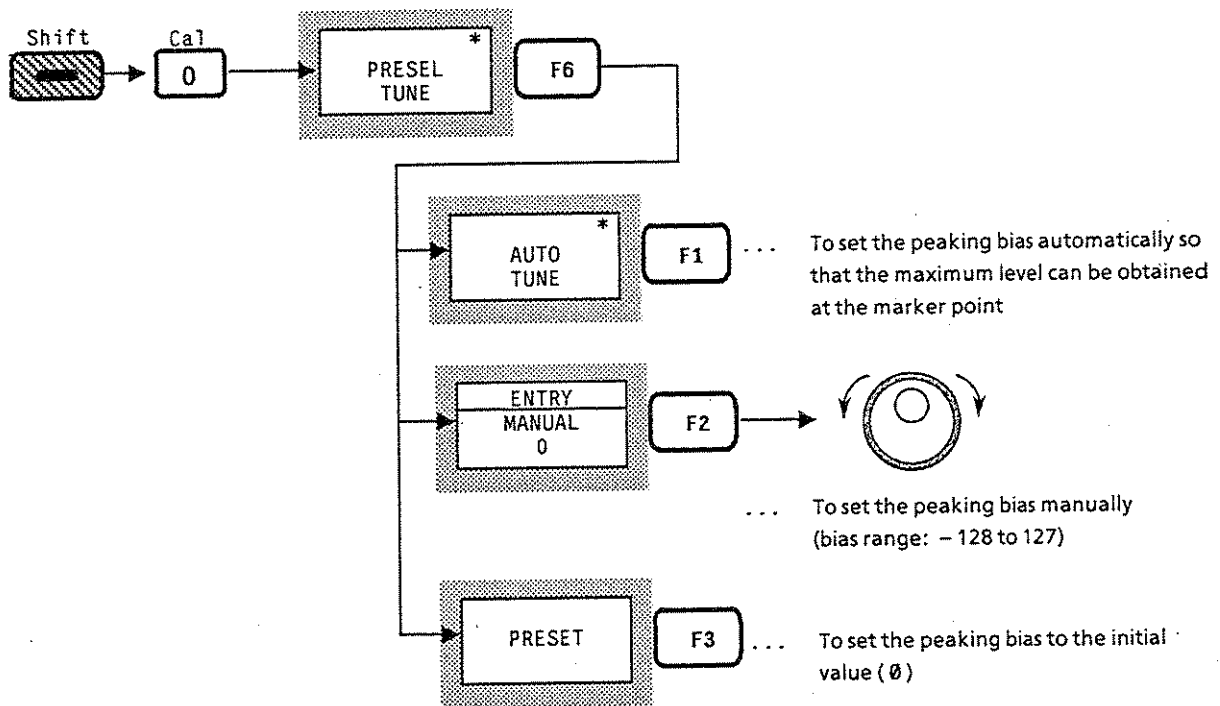

Note: The following conditions prevent the preselector *AUTO TUNE* from executing.

- The frequency span exceeds 500 MHz.
- The marker is set to *OFF*.
- The Trace BG is set to the main trace in the Trace A / Trace BG display mode.
- The Trace time is displayed in the FM / TRIG monitor mode.

8.3 Measurement System Correction

When measuring with a spectrum analyzer, sometimes it is necessary to correct the error and gain of the measurement system. The following are provided as examples of these.

- ① Frequency characteristics and loss of measurement cables
- ② Frequency characteristics and loss of pre-amplifier etc. connected to RF INPUT connector
- ③ When wanting to measure the field strength with an antenna or near-field probe connected (antenna factor correction)

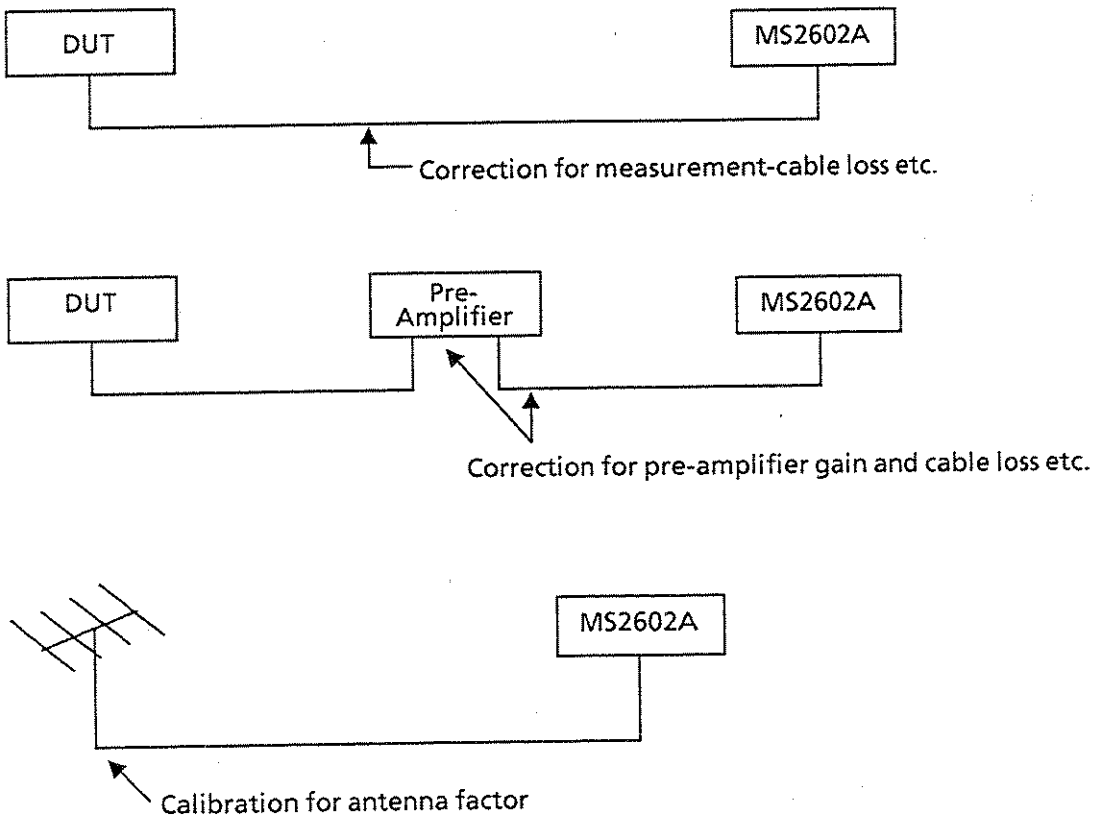

In the MS2602A, correction factors for these measurement systems can be stored in the internal memory to add the factor to the measured value and display the spectrum.

The 5 types of correction factors can be stored in the internal memory. For these storage methods, there are storage via the GPIB interface from an external computer and storage using the internal PTA.

For a more detailed explanation of these methods, refer to the GPIB Remote Control part of the separate operation manual.

The following key operations show how to add the correction factor to the measured value using the already-memorized correction data.

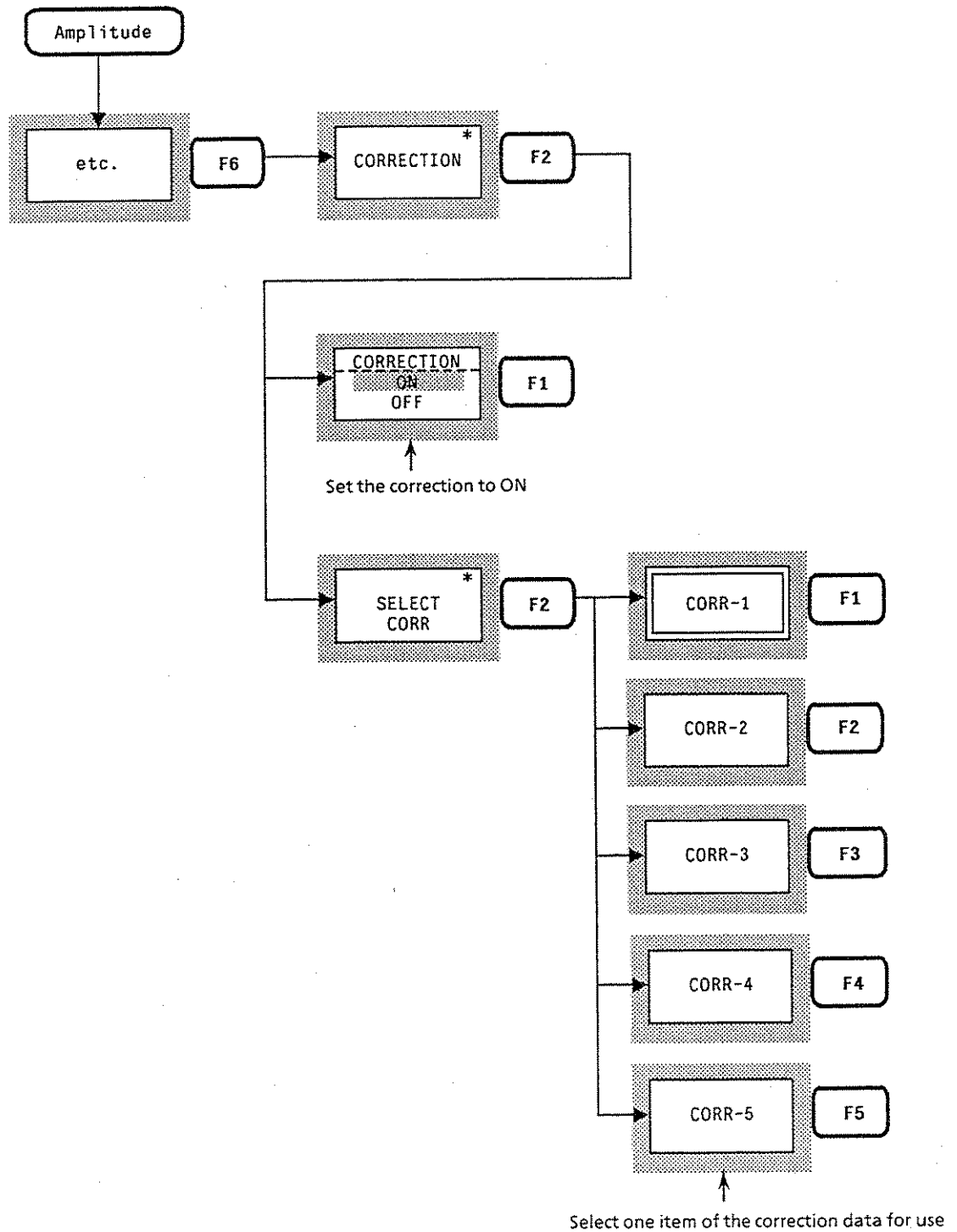

Press one of the F1 to F5 soft keys shown in the CORRECTION menu as appropriate. The spectrum data is corrected and displayed by the relevant correction value corresponding to its menu label.

If the frequency range over which the correction values are entered is from F_a to F_b , displayed frequency ranges lower than F_a or higher than F_b , have correction values applied as shown in the diagram below. The correction value for frequencies lower than F_a is the same as that (L_a) for F_a , and the correction value for frequencies higher than F_b is the same as that (L_b) for F_b .

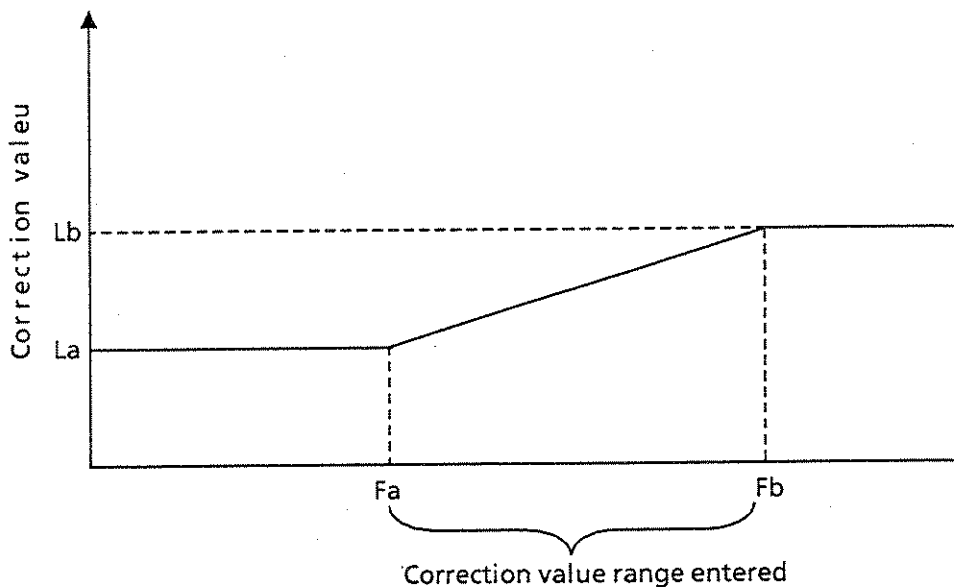

- Notes:**
- No correction factor is entered at factory shipment. The correction values are all 0 dB.
 - The correction value is backed-up by a battery. Therefore, once the value has been entered, it is not lost even after power is turned off.
 - The CORR-1 to CORR-5 soft keys allow each menu label to have up to 24 characters. The labels can be entered via GPIB only. For further details, refer to the GPIB remote control part of the separate operation manual.

SECTION 9

SETTING MEASUREMENT SYSTEM

This section describes the procedure for setting the MS2602A system parameters (conditions for auto coupled function, number of measurement data points, etc.) depending on the use. These system settings are not influenced by the initial settings.

TABLE OF CONTENTS

9.1	Measurement System Settings	9-3
9.1.1	Sweep time setting conditions in Auto mode AUTO SWT	9-3
9.1.2	Number of data points DATA POINTS	9-4
9.1.3	Common / independent settings for coupled function between frequency domain and time domain COUPLE MODE	9-6
9.2	Setting the date and time	9-8
9.2.1	Setting the date	9-8
9.2.2	Setting the time	9-8
9.2.3	Setting the display format of the date	9-8

(Blank)

SECTION 9

SETTING MEASUREMENT SYSTEM

The following system parameters of the MS2602A can be pre-set depending on the use.

- Sweep time setting conditions in Auto mode AUTO SWT
- Number of data points DATA POINTS
- Common / independent settings for coupled function
between frequency domain and time domain COUPLE MODE

These system settings are not influenced by the initial settings. However, they are included in the SAVE parameters described in SECTION 10, so the system settings may have changed when recalled.

The header key for the system settings is shown in the diagram below.

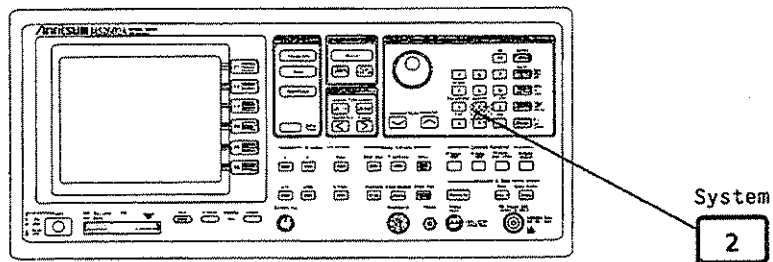

9.1 Measurement System Settings

9.1.1 Sweep time setting conditions in Auto mode AUTO SWT

When the sweep time is set to Auto, the sweep time is calculated by the following expression using the current frequency-span and resolution-bandwidth values.

$$\text{Sweep time: Swp Time} = K \times \frac{\text{SPAN}}{\text{RBW}^2} \quad (\text{when RBW} \leq \text{VBW})$$

$$\text{or else} \quad K \times \frac{\text{SPAN}}{\text{RBW} \times \text{VBW}} \quad (\text{when RBW} > \text{VBW})$$

By changing the K value of the above expression, it is possible to change the sweep time settings for resolution bandwidth RBW when the sweep time is set to Auto.

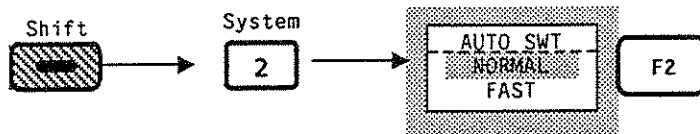

Select the setting for AUTO SWT

- FAST Gives $K = 2$ and sweeps at a comparatively high speed. Use this when measurement accuracy is not required.
- NORMAL ... Gives $K = 3$ and decreases the sweep speed. Use this when measurement accuracy is required.

The AUTO SWT parameter is set at the factory to "NORMAL".

9.1.2 Number of data points DATA POINTS

This system parameter specifies the number of data points when measurement is made on the frequency axis (time axis for time domain). Either 501 points or 1002 points can be selected for the number of data points.

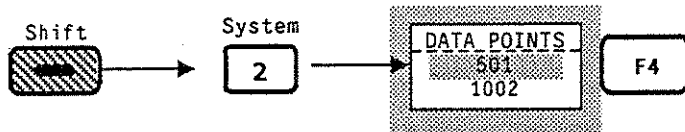

Select number of data points

The number of data points is set to 501 points at factory shipment. Use 501 points for most applications, and 1002 points for special applications only.

Regardless of whether the number of data points is set to 501 or 1002, only 501 data points are displayed on the CRT screen. Therefore, the displayed waveforms hardly change. The relationship between the measurement points and display points is shown below in an example in the frequency range 0 to 1 GHz.

(1) Data point: At 501 points

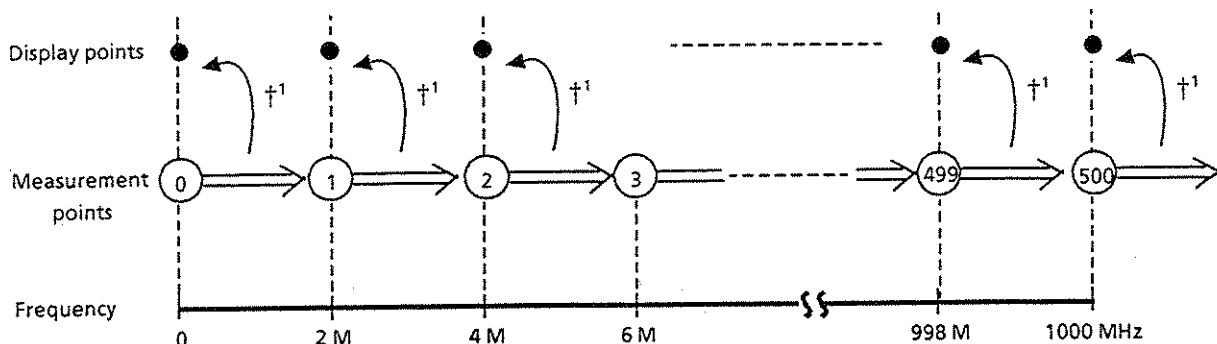

†¹ According to the detection mode, the maximum or minimum value between the current point (sample point) and the next data point (sample point) is displayed as the measured data on the CRT screen. (For further details, see page 5-20)

(2) Data point: At 1002 points

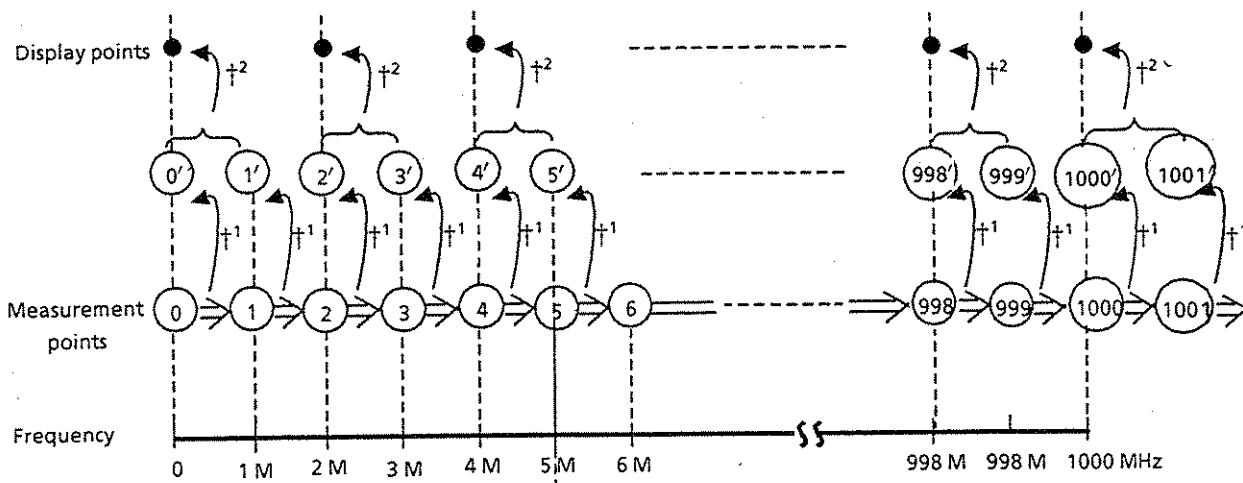

†¹ According to the detection mode, the maximum or minimum value between the current point (sample point) and the next data point (sample point) is available for the measured data. (For further details, see page 5-20)

†² The larger one is displayed in POS PEAK mode, the smaller one is displayed in NEG PEAK mode, and the arithmetical mean is displayed in SAMPLE detection mode.

Note: The marker level always displays the measured data (0', 1', 2'...) with the maximum level present within the zone marker. This causes that the trace peak point (level at display point) does not coincide with the marker level reading when there are 1002 data points in SAMPLE or NEG PEAK detection modes.

To resolve this problem, the number of data points should be set to 501 except when the measured data is processed by an external computer, or when a large number of data points exceeding 501 points are required for various types of measurements which are executed with the Measure key.

9.1.3 Common/independent settings for coupled function between frequency domain and time domain COUPLE MODE

At factory shipment, the four coupled functions of RBW, VBW, Swp Time (Time Span), and Atten are set to have the same values between frequency domain and time domain. This gives the same operation as the zero span of a traditional spectrum analyzer. If parameters are to be set differently between frequency domain and time domain, to set the RBW, VBW, Swp Time (Time Span) parameters to different values, perform the following System settings.

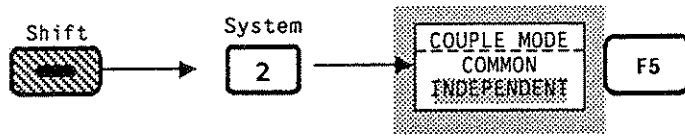

COMMON: The same values are set for both frequency domain and time domain
INDEPENDENT: Different values are set for frequency domain and time domain

It is impossible to set the Atten value independently. When the COUPLE MODE is set to INDEPENDENT while time domain mode. 'RB' and 'VB' displayed at the top of the screen are changed to 'RBt' and 'VBt', respectively.

Note: The sweep time (time span) setting range and resolution between frequency domain and time domain are different as shown below. In some cases, the same values cannot be obtained even if the couple mode is set to COMMON.

At frequency domain:

- 20 msec to 1000 sec (when the DISPLAY mode other than the simultaneous display of trace A and trace B are set in 501 data point)
Resolution: Higher-order two digits
- 50 msec to 1000 sec (when set to 1002 data point or when the simultaneous display of trace A and trace B are set)
Resolution: Higher-order two digits

At time domain:

- 50 μ sec to 1000 sec (when data point is set to 501)
Resolution: Higher-order one digit (100 to 900 μ sec)
Higher-order two digits (1 msec to 1000 sec)
- 100 μ sec to 1000 sec (when data point is set to 1002)
Resolution: Even higher-order one digit only (200 to 800 μ sec)
Even higher-order two digit only (1 msec to 1000 sec)

Example: After switching to time domain to set the time span to 100 μ sec when the sweep time is 300 msec in frequency domain mode, it switches to frequency domain.



Since the lower limit value of the sweep time that can be set in frequency mode is 20 msec, the sweep time is set to the 20 msec nearest to 100 μ sec. Then, when it switches to time domain, the time span is renewed to 20 msec.

9.2 Setting the date and time

The date and time can be set by following the procedure described below.
To display the date and time that have been set, refer to the display of title character strings (P.11-11).

9.2.1 Setting the date

Set the date by following the procedure described below.
Use the “.” (period) mark to separate the year, month and date.

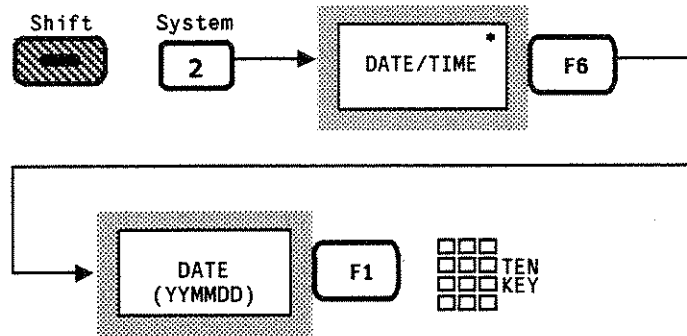

9.2.2 Setting the time

Set the time by following the operation described below.
Use the “.” (period) mark to separate the hour, minutes and seconds.

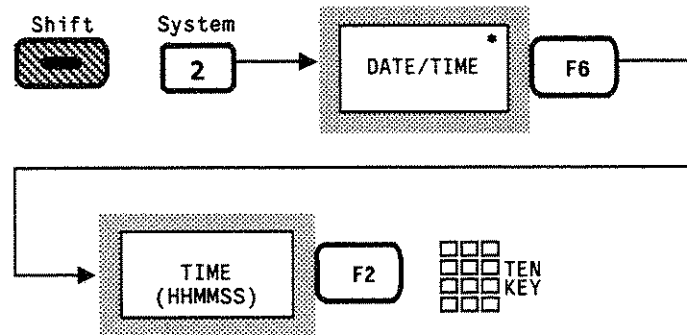

9.2.3 Setting the display format of the date

Every time the F3 key is pressed, the following status is selected in order.

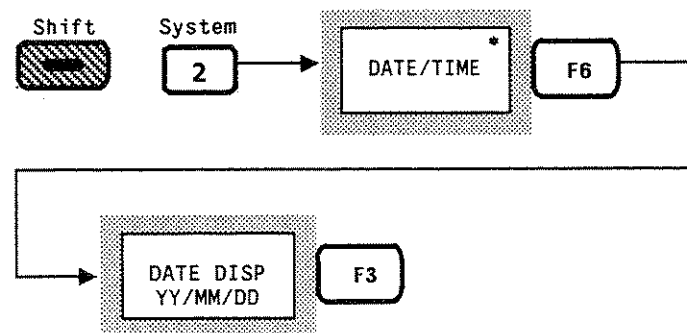

SECTION 10

SAVE / RECALL FUNCTION

This section describes saving and recalling the waveform data and parameter data to and from the internal memory and PMC file, respectively.

TABLE OF CONTENTS

10.1	SAVE / RECALL to Internal Memory	10-5
10.1.1	SAVE	10-5
10.1.2	RECALL	10-6
10.2	Saving / Recalling and Managing the PMC File	10-7
10.2.1	Selecting media	10-7
10.2.2	Formatting the PMC file	10-8
10.2.3	SAVE	10-8
10.2.4	RECALL	10-9
10.2.5	Displaying the directory	10-10
10.2.6	Write protection	10-11
10.2.7	Deleting a file	10-11
10.2.8	PMC error messages	10-12

(Blank)

SECTION 10

SAVE / RECALL FUNCTION

The MS2602A can save and recall the measurement conditions and measured results to and from memory for later use.

The MS2602A uses a memory system consisting of four types of storage media: Internal memory, PMC (used with a slot attached to the MS2602A main instrument), PMC (used with a slot attached to MC8104A), and a floppy disk (used with a drive attached to MC8104A).

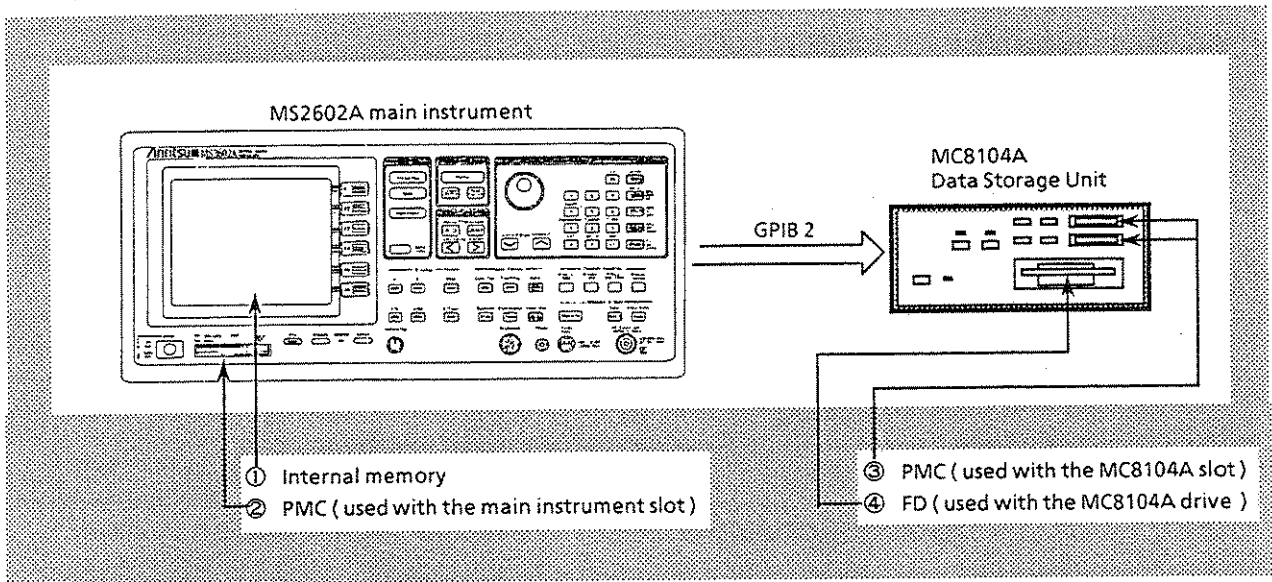

Refer to the MC8104A Operation Manual for items ③ and ④.

This paragraph explains items ① and ②.

An outline of items ① and ② is as follows:

①	Internal memory	<ul style="list-style-type: none"> • Uses the RAM backed-up by a battery in the MS2602A main instrument • Number of files that can be saved and recalled .. 16 • Save data Waveform data with parameters • Recall data Waveform data with parameters, or only parameters 																																		
②	PMC	<ul style="list-style-type: none"> • Number of files saved and recalled <table border="1" data-bbox="326 540 1360 1017"> <thead> <tr> <th rowspan="2">Conditions</th> <th colspan="2">One trace display</th> <th colspan="2">Two trace display</th> </tr> <tr> <th>Data point : 501</th> <th>Data point : 1002</th> <th>Data point : 501</th> <th>Data point : 1002</th> </tr> </thead> <tbody> <tr> <td>PMC capacity 32 KB</td> <td>11</td> <td>8</td> <td>8</td> <td>5</td> </tr> <tr> <td>PMC capacity 64 KB</td> <td>23</td> <td>16</td> <td>16</td> <td>10</td> </tr> <tr> <td>PMC capacity 128 KB</td> <td>48</td> <td>34</td> <td>34</td> <td>22</td> </tr> <tr> <td>PMC capacity 256 KB</td> <td>98</td> <td>71</td> <td>71</td> <td>45</td> </tr> <tr> <td>PMC capacity 512 KB</td> <td>99</td> <td>99</td> <td>99</td> <td>90</td> </tr> </tbody> </table> <p data-bbox="396 1023 1300 1091"><i>(Note: Provided all the contents saved in the PMC are waveform data and parameters, and also the conditions of all the files are the same.)</i></p> <ul style="list-style-type: none"> • Save data Waveform data with parameters • Recall data Waveform data with parameters, or only parameters 	Conditions	One trace display		Two trace display		Data point : 501	Data point : 1002	Data point : 501	Data point : 1002	PMC capacity 32 KB	11	8	8	5	PMC capacity 64 KB	23	16	16	10	PMC capacity 128 KB	48	34	34	22	PMC capacity 256 KB	98	71	71	45	PMC capacity 512 KB	99	99	99	90
Conditions	One trace display			Two trace display																																
	Data point : 501	Data point : 1002	Data point : 501	Data point : 1002																																
PMC capacity 32 KB	11	8	8	5																																
PMC capacity 64 KB	23	16	16	10																																
PMC capacity 128 KB	48	34	34	22																																
PMC capacity 256 KB	98	71	71	45																																
PMC capacity 512 KB	99	99	99	90																																

10.1 SAVE / RECALL to Internal Memory

This paragraph describes saving and recalling the waveform data and parameters to and from the internal memory.

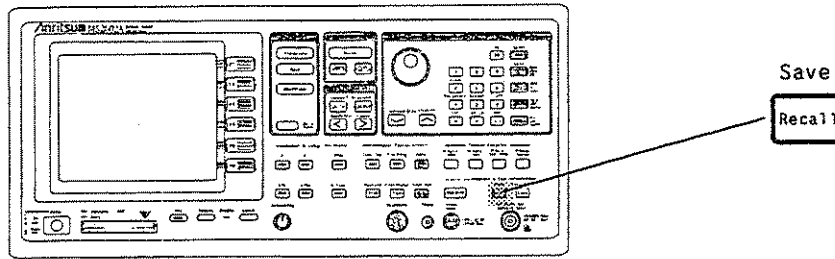

10.1.1 SAVE

To save the current waveform data and parameters to the internal memory, perform the following key operation.

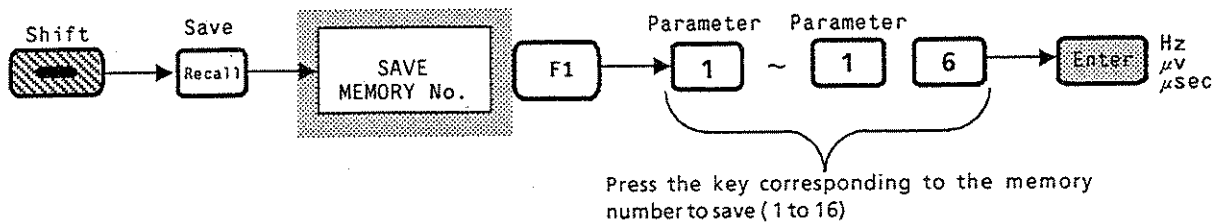

When the SAVE has completed, "SAVE completed" is displayed at the lower-right side of the screen.

Note: Since the previous data written using the same memory number is overwritten by the save operation, check the directory before saving.

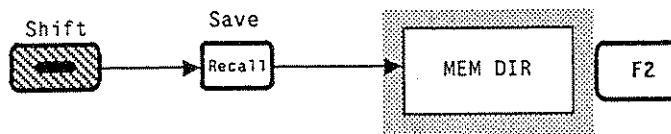

Memory Directory		
Memory-no.	Title	Date
01	NOISE LEVEL MEASUREMENT	92-09-20
02	*****Empty*****	**--**
03	*****Empty*****	**--**
04	*****Empty*****	**--**

10.1.2 RECALL

To recall saved waveform data and parameters from the internal memory, perform the following key operation.

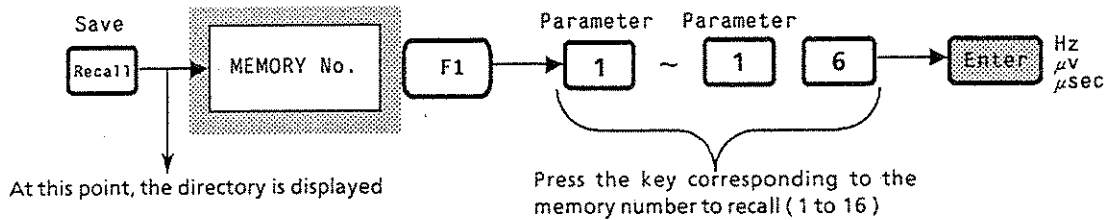

The data to be recalled can be selected from either waveform data with parameters or parameters only.

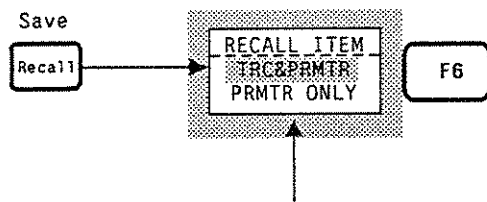

TRC & PRMTR: Recalls both waveform data and parameters

PRMTR ONLY: Recalls parameters only

- Notes:**
- ① *Waveform data should be saved in the VIEW storage mode or in the sweep state while stopped after a single sweep. Data which is saved during a continuous sweep is cleared from the screen display because of the resweep immediately after recall.*
 - ② *The CUMULATIVE or OVERWRITE storage mode allows the last-swept waveform data to be saved.*
 - ③ *Since the system settings described in SECTION 9 (AUTO SWT, DATA POINT and COUPLE MODE) are included in the parameters to be saved, these system settings may have changed when recalled.*

10.2 Saving / Recalling and Managing the PMC File

This paragraph describes saving and recalling the waveform data and parameters to and from PMC.

For the precautions for handling PMC, refer to SECTION 2 (page 2-11) in the Basic Operating Instructions part of the separate Operation Manual.

10.2.1 Selecting media

Select the media as follows, then perform the SAVE / RECALL operations.

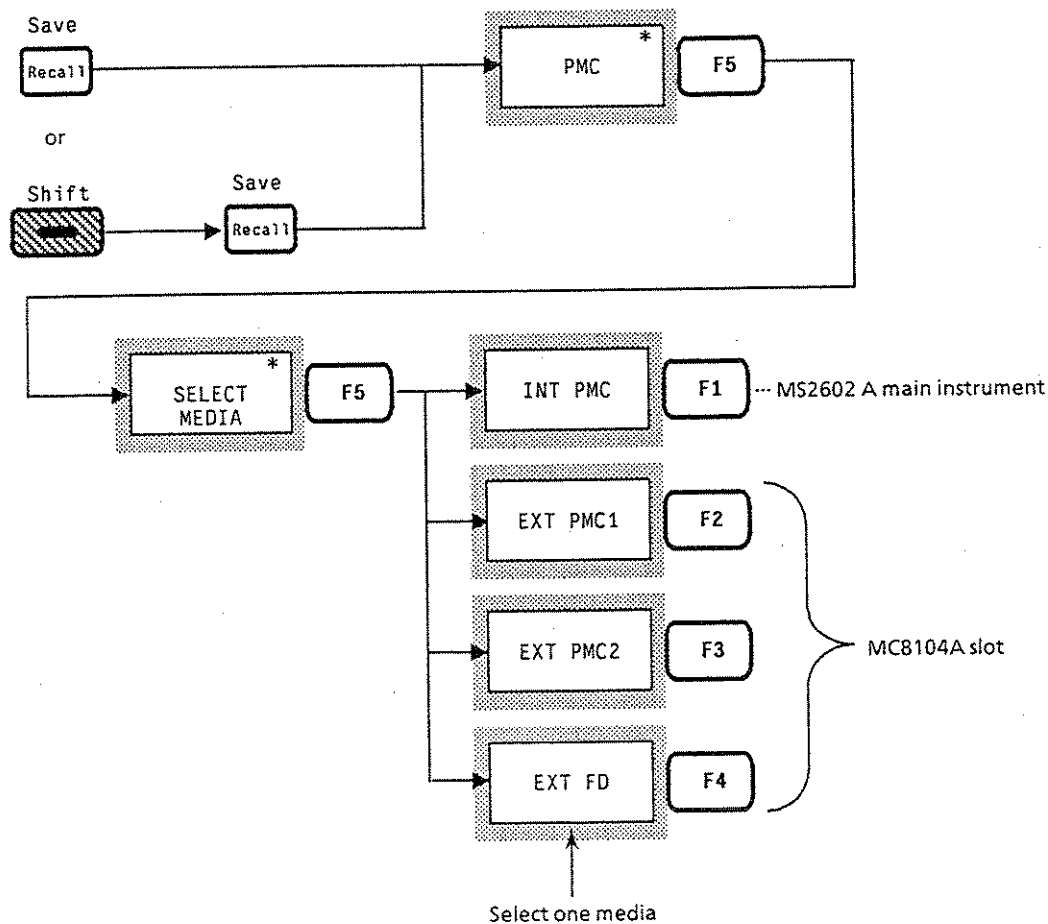

10.2.2 Formatting the PMC file

To use a new PMC, format the new PMC as follows before using it. The PMC must be first inserted correctly into the slot attached to the MS2602A main instrument.

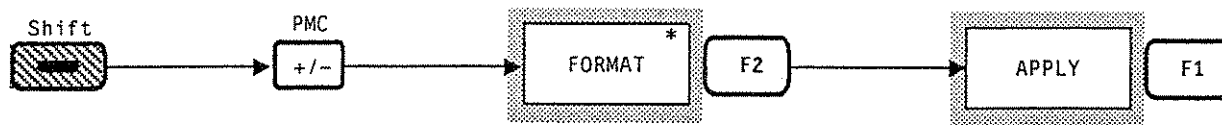

When formatting is completed, "Formatting completed" is displayed at the lower-right side of the screen.

Note: When a PMC file is formatted, all the file contents are deleted even if they are write-protected as described on page 10-11.

10.2.3 SAVE

To save the current waveform data and parameters to the PMC, perform the following key operation.

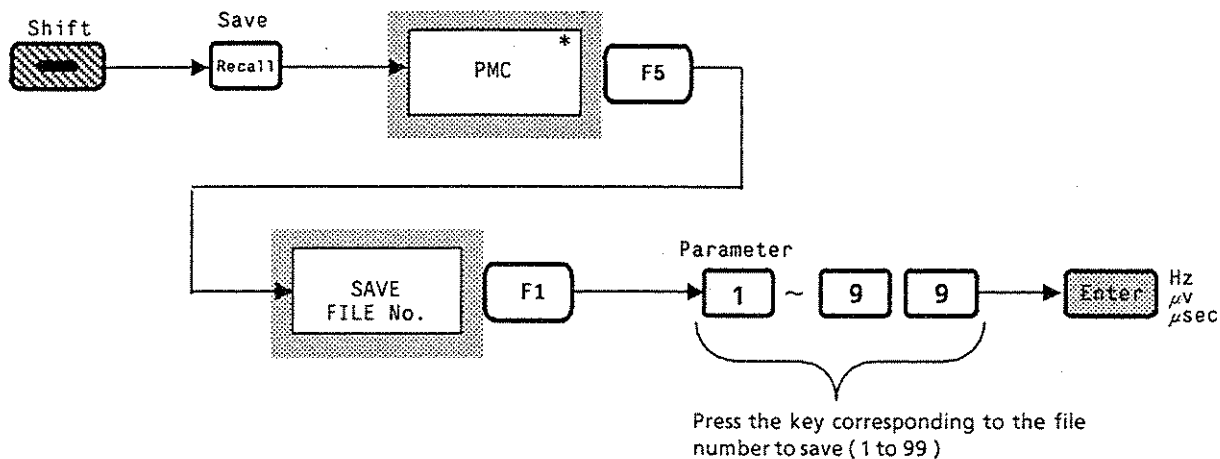

Note: The file number can be specified from 1 to 99, but this does not mean that 99 files can be saved. The number of files which can be saved depends on the PMC capacity. (See page 10-4.)
The previous data written in the same memory number is overwritten by the save operation. To prevent this, check the directory before saving. (See page 10-10.)
Important saved files can be protected from overwriting by using the write protect. (See page 10-11 or refer to SECTION 2 in the Basic Operating Instructions part of the separate Operation Manual.)

10.2.4 RECALL

To recall previously-saved waveform data and parameters from the internal memory, perform the following key operation.

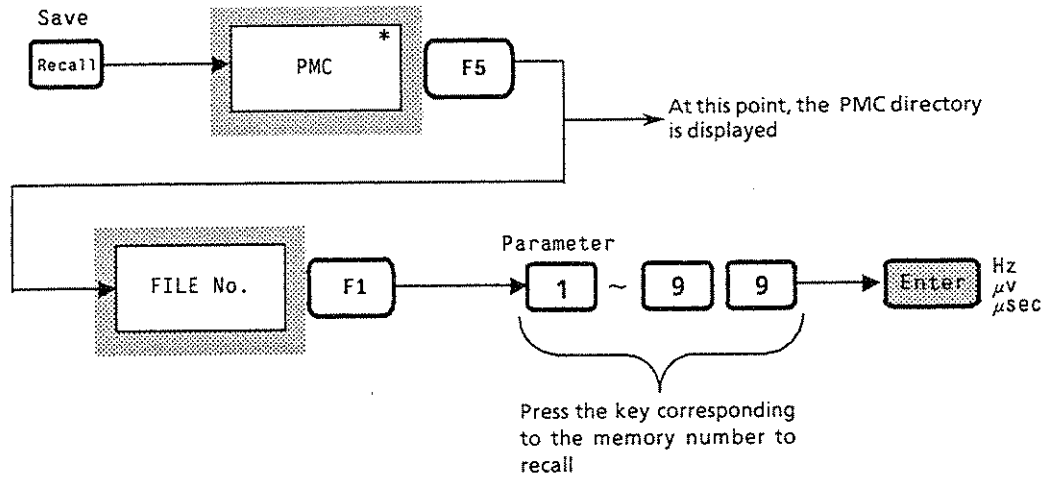

The data to be recalled can be selected from either waveform data with parameters, or parameters only.

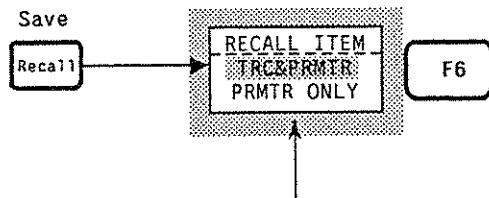

TRC & PRMTR: Reads out both waveform data and parameters

PRMTR ONLY: Reads out parameters only

- Notes:**
- ① *Waveform data should be saved in the VIEW storage mode or in the sweep state while stopped after a single sweep. Data which is saved during a continuous sweep is cleared from the screen display because of the resweep immediately after recall.*
 - ② *The CUMULATIVE or OVERWRITE storage mode allows the last-swept waveform data to be saved.*
 - ③ *Since the system settings described in SECTION 9 (AUTO SWT, DATA POINT, and COUPLE MODE) are included in the parameters to be saved, these system settings may have changed when recalled.*

10.2.5 Displaying the directory

To display the PMC directory, perform the following key operation.

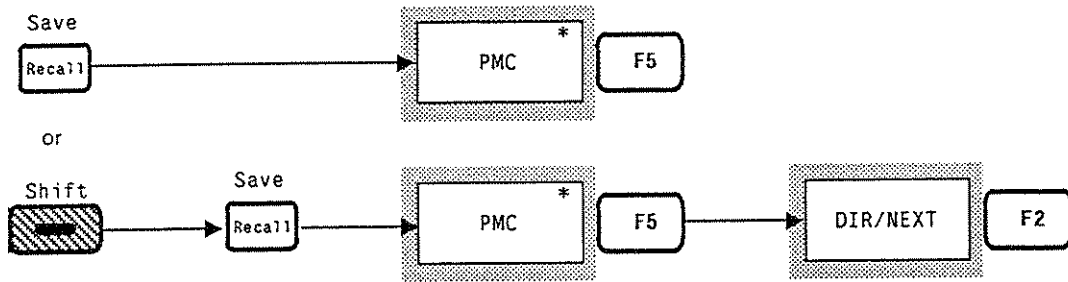

File Directory				
MEDIA : INT PMC		MEDIA NAME : MS2602		
UNUSED AREA : 11 264 Bytes				
7 Files in ¥ms2602¥TRACE				
File-Name	Title	Bytes	Date	prot.
TRACE001 DAT	Noise Measure 1 (800MHz)	2560	92-09-20	on
TRACE002 DAT	Noise Measure 2 (800MHz)	2560	92-09-20	off
TRACE003 DAT	Noise Measure 3 (800MHz)	2560	92-09-20	off
TRACE011 DAT	Noise Measure 1 (1500MHz)	2560	92-09-21	on
TRACE012 DAT	Noise Measure 2 (1500MHz)	2560	92-09-21	off
TRACE013 DAT	Noise Measure 3 (1500MHz)	2560	92-09-21	off
TRACE021 DAT	Distortion	2560	92-09-25	on

Annotations:

- File No. and Attribute: Indicated by arrows pointing to the first two columns of the file list.
- Title message displayed in the title field at the top of the screen when saved: Indicated by a bracket under the Title column.
- File size: Indicated by an arrow pointing to the Bytes column.
- Date when saved: Indicated by a bracket under the Date column.
- Protected or not: Indicated by an arrow pointing to the prot. column.

The directory can display up to 16 files on one screen. If there are more than 16 files, the next 16 files can be displayed by pressing the [F2] (DIR / NEXT) key.

10.2.6 Write protection

To set write protection for a specified file, perform the following key operation.

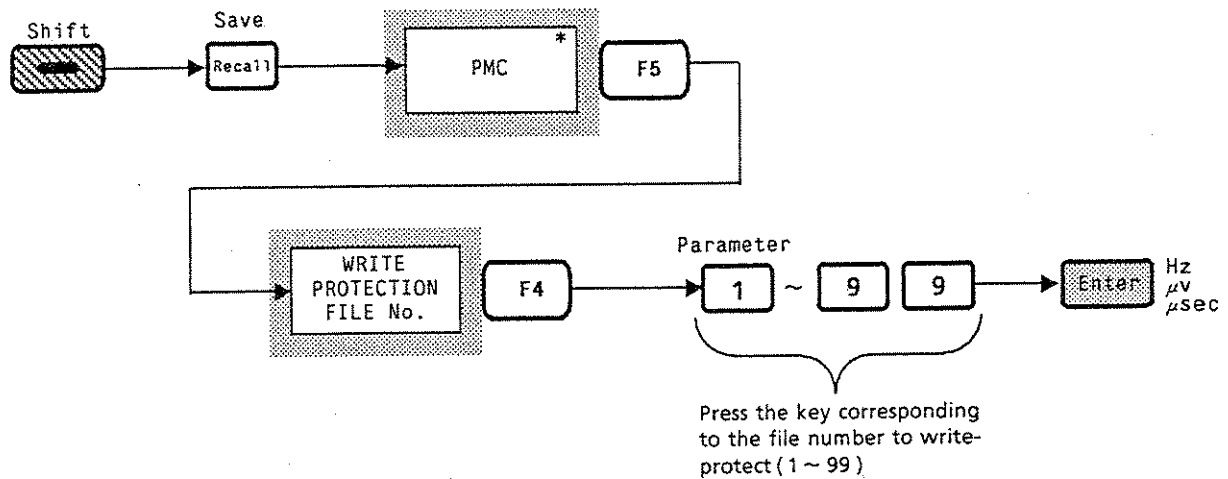

To release the write protection, perform the save operation again for the same file number.

Since write-protected files are displayed with the right most "prot." column set to "on" as shown in the directory display on page 10-10, the files cannot be saved or deleted while write-protected.

10.2.7 Deleting a file

To delete file, perform the following key operation.

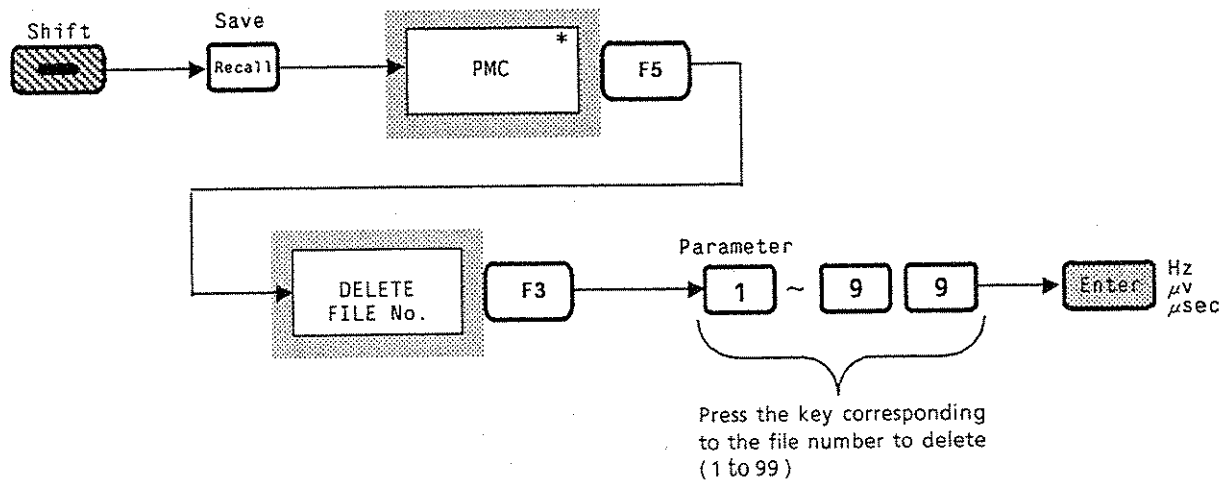

When the PMC write-protect switch or the floppy disk file switch is ON, it is impossible to delete the file contents. (For information on the PMC write-protect switch, refer to SECTION 2 of the Basic Operating Instruction part in the separate Operation Manual.)

10.2.8 PMC error messages

If a PMC error occurs when a PMC function is executed, the following error messages are displayed in the communication field.

Error message	Details of error
450 Media write protected	Media (PMC or FD) is write-protected
451 Media not installed	Media is not installed
452 Insufficient memory	Media memory is insufficient
453 File not found	Specified file is not found on the media
454 Read / Write ERROR	Media read / write error occurred
455 Memory type is different	Memory type is different
456 Media not formatted	Media is not formatted
460 Other Media ERROR	Other media error

SECTION 11

COPY / SOUND MONITOR

This section describes the COPY function for hard-copying the contents displayed on the screen and the SOUND function for monitoring an AM or FM modulated sound signal.

TABLE OF CONTENTS

11.1	Direct Plotting	11-3
11.1.1	Connecting to a printer/plotter	11-3
11.1.2	Selecting a printer	11-4
11.1.3	Selecting and setting a plotter	11-5
11.1.4	Hard-copying	11-10
11.2	Displaying the Title	11-11
11.3	List of Measurement Parameters and System Settings	11-13
11.4	SOUND Monitor	11-14
11.4.1	Sound monitor from AM wave	11-15
11.4.2	Sound monitor from FM wave	11-15

(Blank)

SECTION 11

COPY / SOUND MONITOR

11.1 Direct plotting

The MS2602A can output a hard copy of the screen as follows.

- ① Using a printer via GPIB interface
- ② Using a plotter via GPIB interface
- ③ Using a video printer

The hard-copy procedure is explained below.

11.1.1 Connecting to a printer / plotter

The MS2602A and printer / plotter are connected as shown below.

- (1) Connecting to a printer (HP2225C, VP800), to the Data Storage Unit built-in printer (MC8104A) or plotter (HP-GL, GP-GL)

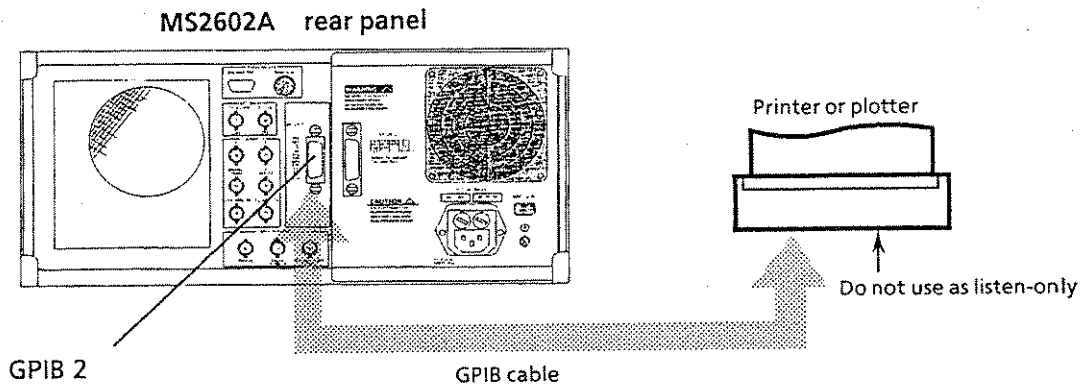

- (2) Connecting to the UA-455A / VP-1500 II video printer

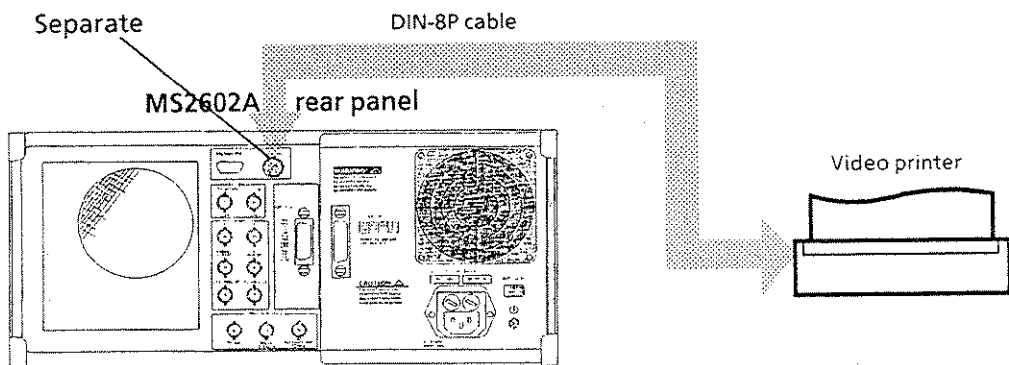

11.1.2 Selecting a printer

To select a printer to use and to set its GPIB address, perform the following key operations.

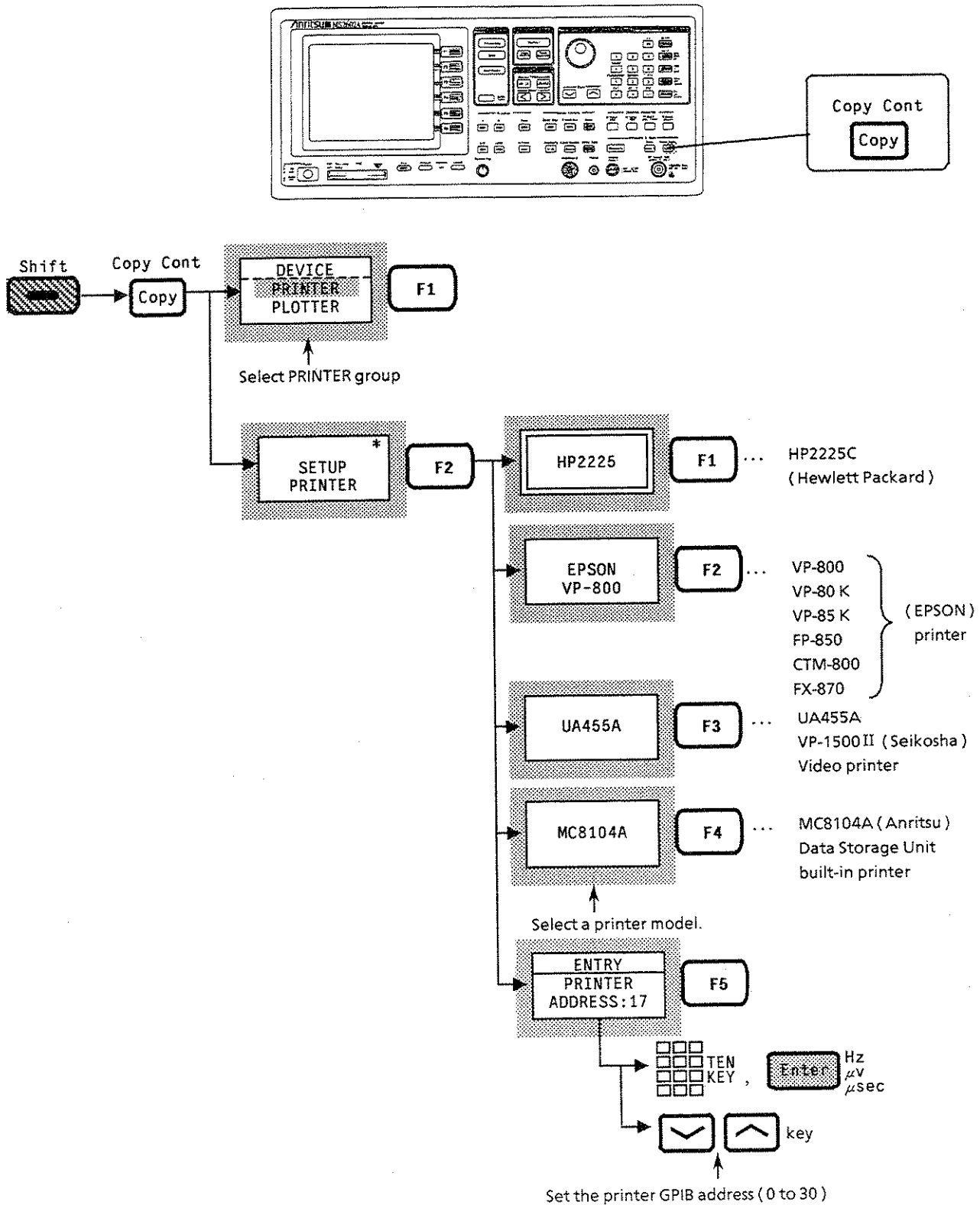

Note: When the UA455A / VP-1500 II video printer is used, it is not necessary to set the GPIB address. The GPIB address for using the MC8104A Data Storage Unit does not require the address that is set here, but requires the MC8104A address that is set in SECTION 12 'INTERFACE / PMC' or in SECTION 2 'CONNECTING BUS AND SETTING ADDRESS' in the separate GPIB REMOTE CONTROL manual.

11.1.3 Selecting and setting a plotter

(1) Selecting a plotter

Select a plotter and set its GPIB address as follows:

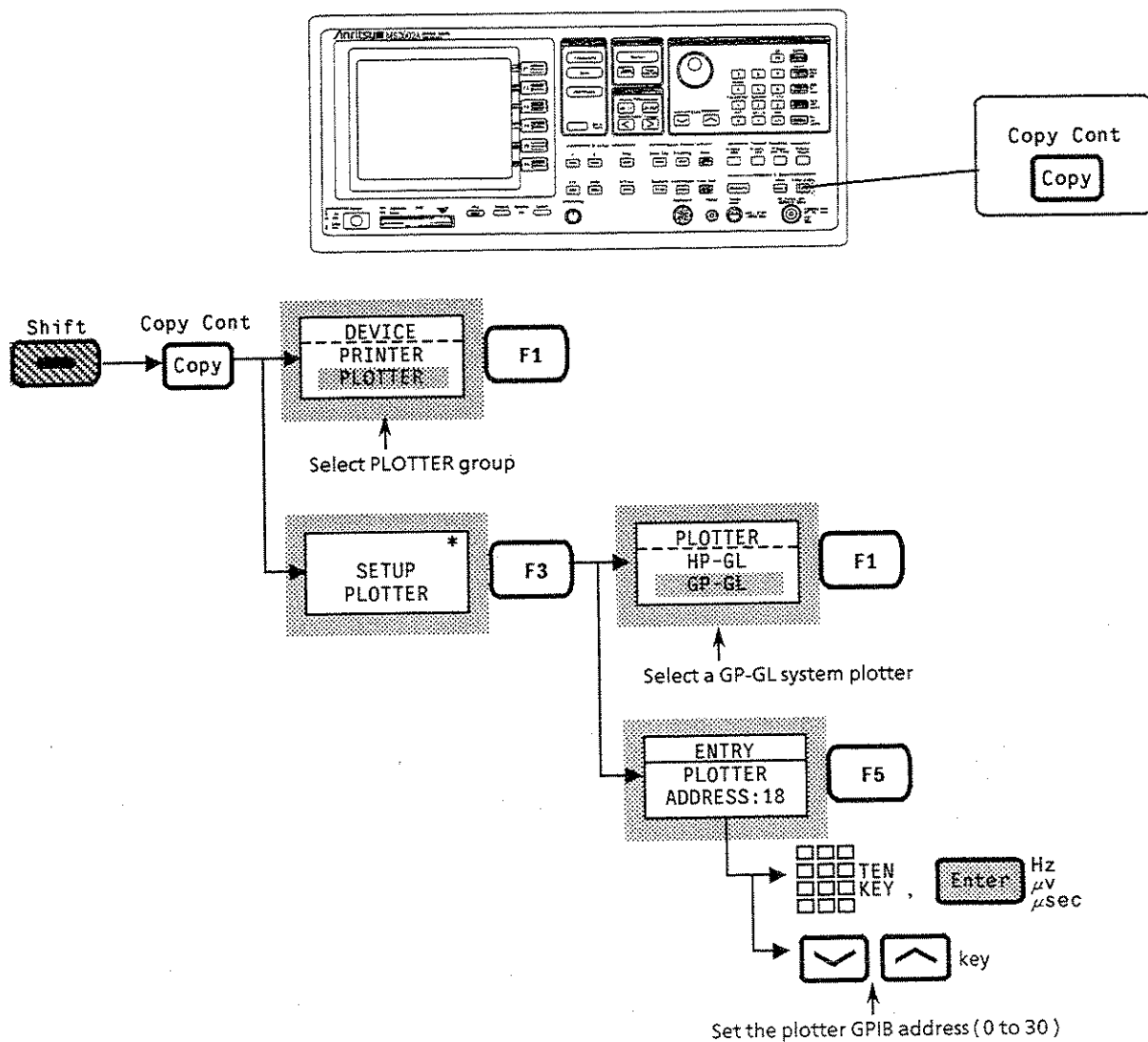

(2) Selecting plotter paper size and plot location

Select plotter paper size and plot location as follows:

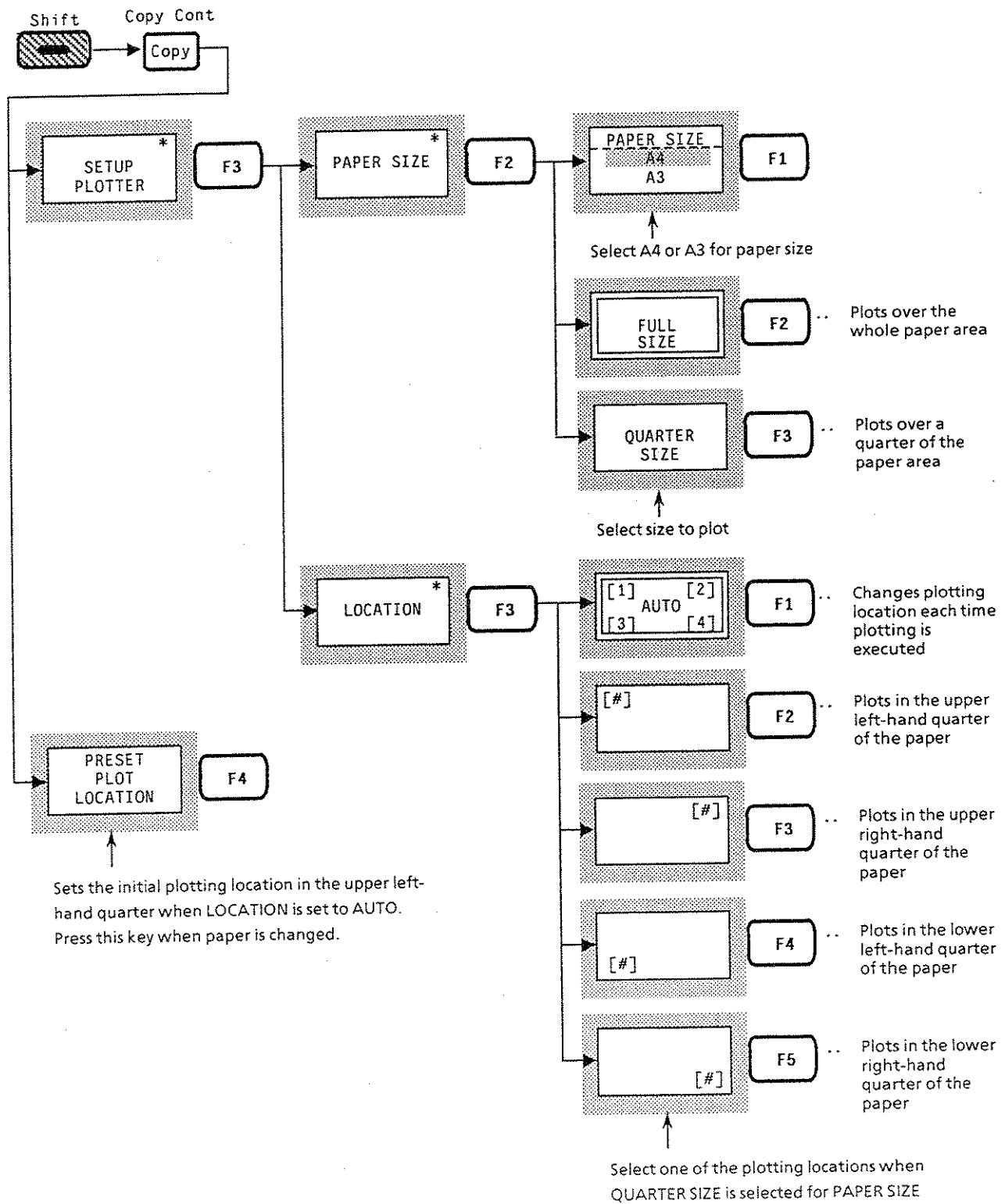

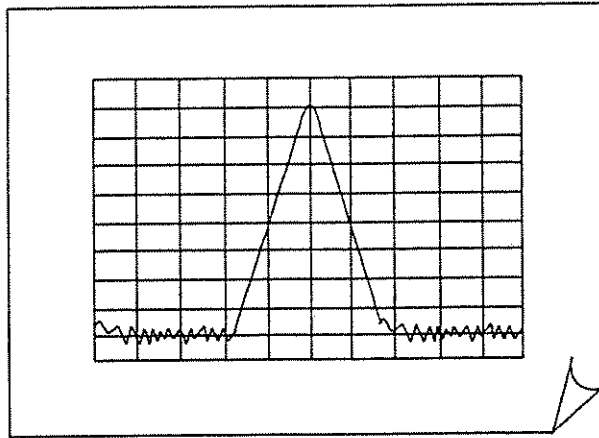

When FULL SIZE is Specified for Plotting

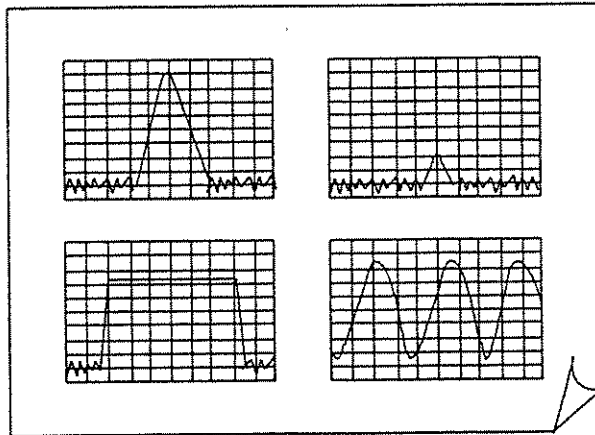

When QUARTER SIZE is Specified for Plotting

(3) Selecting item to plot

Select the item to plot as follows:

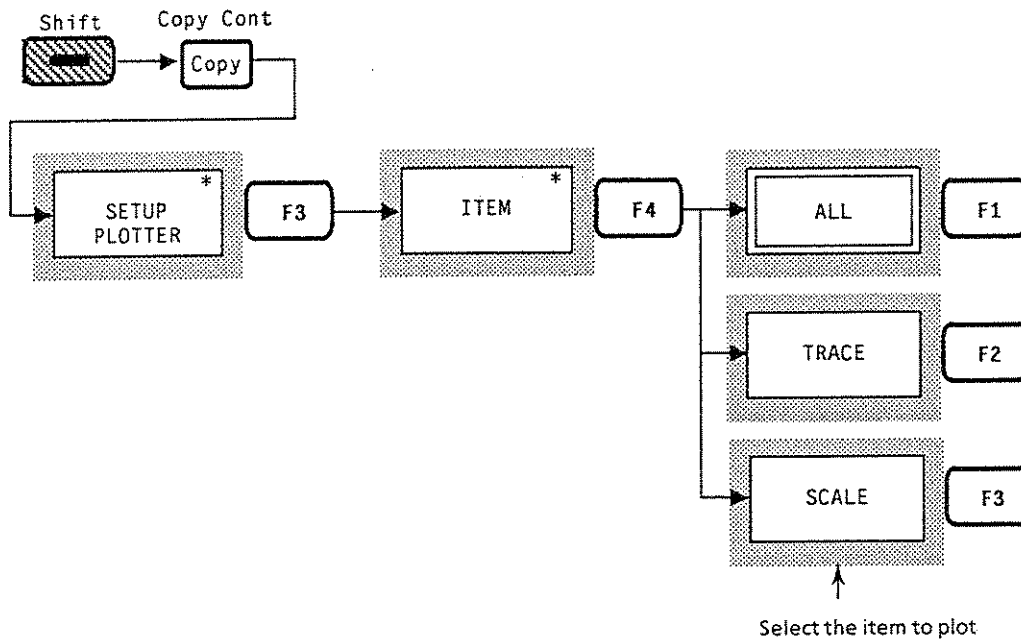

When ALL is selected

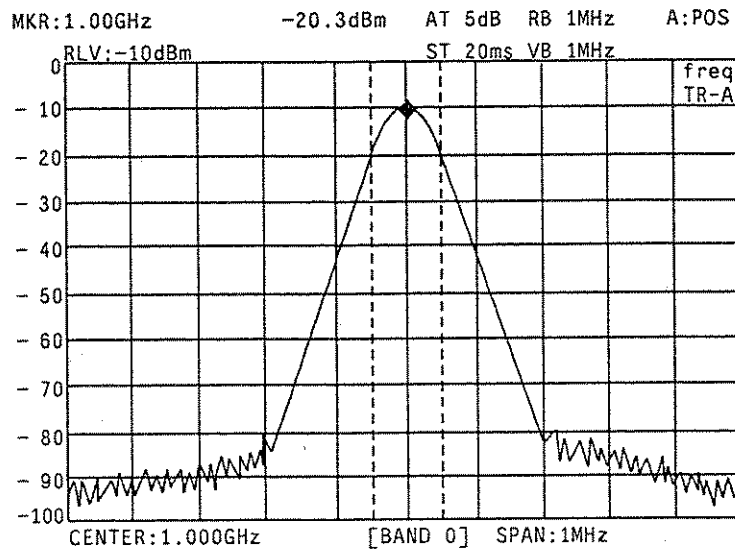

When TRACE is selected

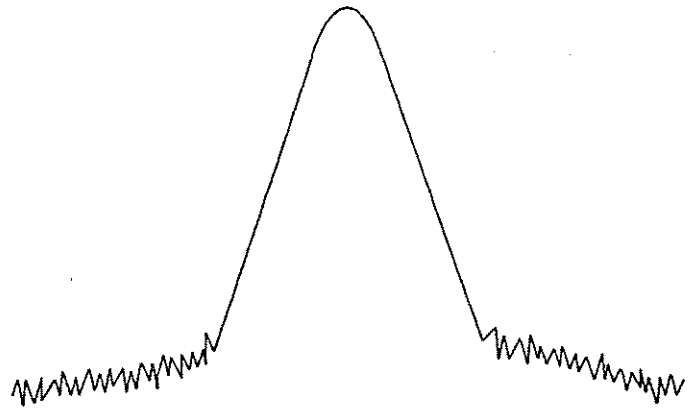

When SCALE is selected

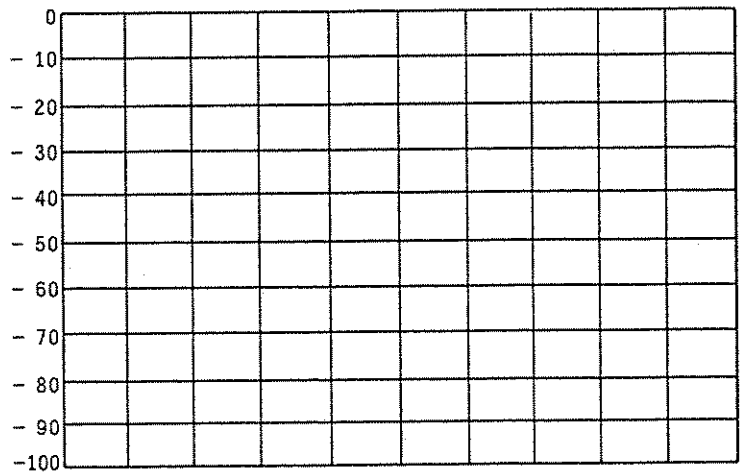

Note: *No soft key menu or communication area is hard-copied to a plotter. The measure window location plotted during measure window display is fixed in the upper right-hand corner regardless of the window location on the CRT screen. The wave trace being displayed in OVERWRITE or CUMULATIVE storage mode allows the last single sweep trace only to be plotted.*

11.1.4 Hard-copying

Press the [Copy] key to start hard-copying.

Note: The printer / plotter should be in ON LINE mode.

Changing a waveform or a marker level display during hard-copying may affect the copy results. To avoid this, stop the sweep before starting the copy or ensure that the trace cannot be rewritten. (For example, select VIEW.) To avoid hard-copying both the function menu and communication field, perform the following key operations, then press the [Copy] key.

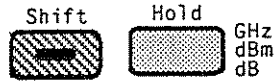

Note: Some printer models and plotter models take a considerable time to output hard copy. This may cause a time-out error in the MS2602A and the hard copy plot may be interrupted. In this case, modify the time-out setting value via GPIB using an external controller.

For N88-BASIC PRINT_@1;"GTOUT_60"

For PTL PUT_"GTOUT_60"

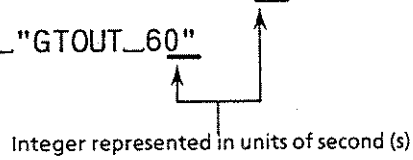

11.2 Displaying the Title

A character string or date / time containing up to 32 characters can be displayed in the title display field on the top of the screen.

To display a title character string, perform the following key operation.

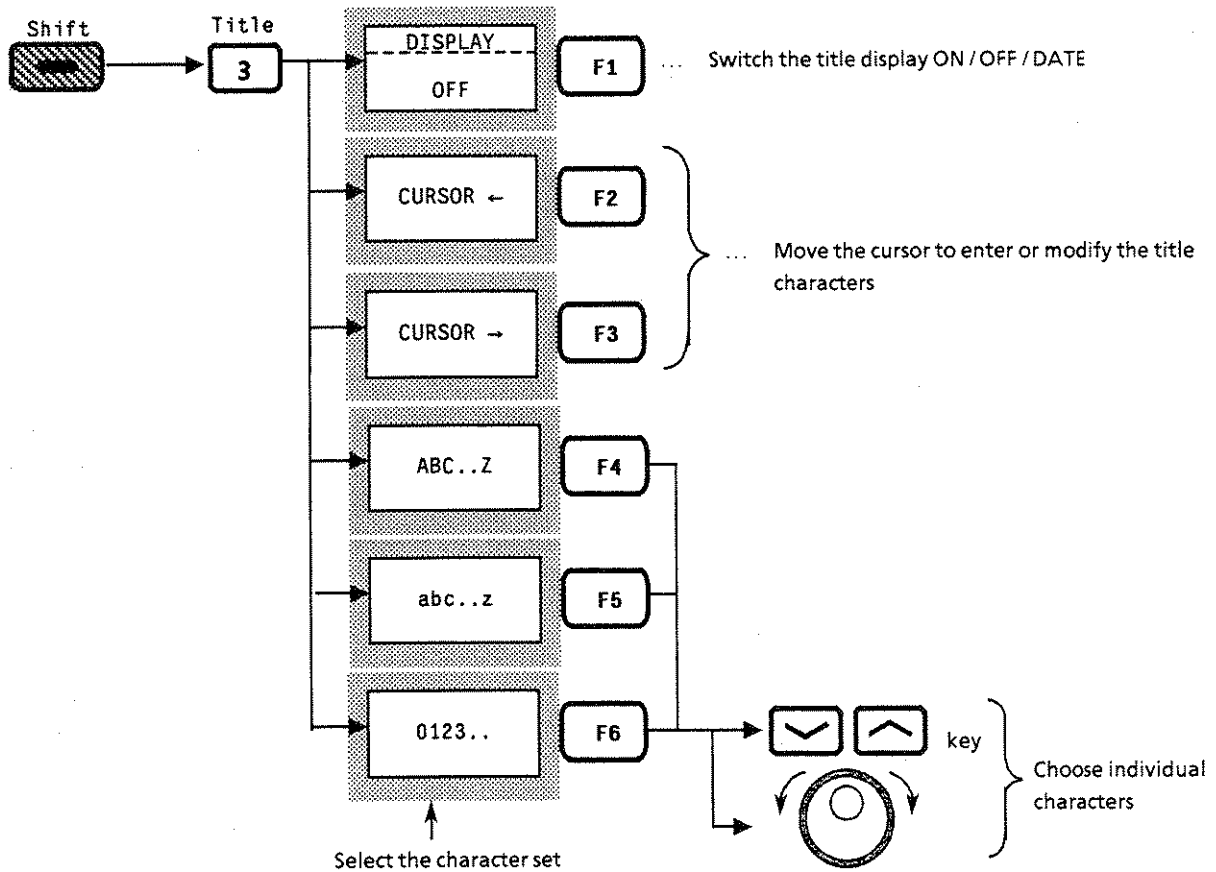

Move the cursor to the right after entering each character and select the next character. Press the [Enter] key after entering all the characters. Numbers and a decimal point can also be entered using the TEN keys (numeric keypad).

Note: To clear the current title character string, press the [Shift][BS][Enter] keys in this order while the title display field is displayed.

The table below shows the characters that can be used with F4 (upper-case letters), F5 (lower-case letters), and F6 (numbers and symbols).

Permitted characters	
Type	Characters
Upper-case letters (F4)	A B C D E F G H I J K L M N O P Q R S T U V W X Y Z
Lower-case letters (F5)	a b c d e f g h i j k l m n o p q r s t u v w x y z
Numbers, symbols (F6)	0 1 2 3 4 5 6 7 8 9 ! " # \$ % & ' () * + , - . /

11.3 List of Measurement Parameters and System Settings

The parameter settings of the MS2602A are displayed on this page.

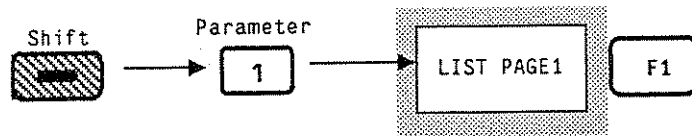

PARAMETER LIST<1>

< TRACE-A,B >		< TRACE-TIME >	
CENTER FREQ :	4.250 000 000GHz	FREQUENCY :	4.250 000 000GHz
FREQ SPAN :	8.500 000 000GHz	TIME SPAN :	260ms
START FREQ :	0Hz	DELAY TIME :	0us
STOP FREQ :	8.500 000 000GHz	EXPAND :	OFF
RES BW :	1MHz	RES BW :	1MHz
VIDEO BW :	100kHz	VIDEO BW :	1MHz
SWP TIME :	260ms	SCALE :	LOG,10dB/
SCALE :	LOG,10dB/		
TR-A STORAGE:	NORMAL		
TR-B STORAGE:	NORMAL		
TR-A DET :	POS PEAK		
TR-B DET :	POS PEAK		
< TRACE-BG >		< COMMON PARAMETERS >	
CENTER FREQ :	4.250 000 000GHz	FREQ BAND :	BAND AUTO
FREQ SPAN :	8.500 000 000GHz	REF LEVEL :	-10.0dBm
START FREQ :	0Hz	RF ATTEN :	5dB
STOP FREQ :	8.500 000 000GHz	LOG UNIT :	dBm

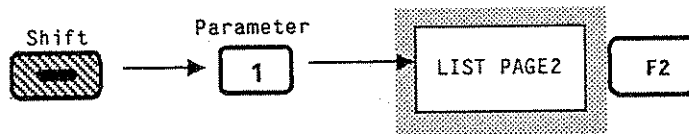

PARAMETER LIST<2>

< TRACE >		< HARD COPY >	
DISPLAY :	TRACE-A	DEVICE :	PLOTTER
FM/TRIG MON :	OFF	PLOTTER :	HP-GL.#18
		PRINTER :	2225.#17
< SWEEP CONTROL >		< MEMORY MEDIA >	
TRIGGER :	FREE RUN	MEDIA :	INT PMC
SWEEP MODE :	CONTINUOUS		
ZONE SWEEP :	OFF	< INTERFACE >	
SIGNAL TRKG :	OFF	PORT-1 :	GP-1B,#1
GATE SWEEP :	OFF		DEVICE
		PORT-2 :	GP-1B,#16
< MARKER >			CONTROLLER
MODE :	NORMAL	< SYSTEM >	
MULTI MKR :	OFF	AUTO SWT :	NORMAL
		DATA POINTS:	501
< OTHERS >		COUPLE MODE:	INDEPENDENT
SOUND :	OFF		

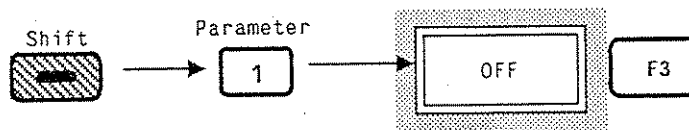

Turning off the list display returns to the normal screen.

11.4 SOUND Monitor

The MS2602A has a SOUND monitor function which demodulates an AM or FM modulated signal and the sound can be listened to using the built-in speaker.

To listen to the sound, first set the center frequency to the receiving frequency, then set the display mode to time domain mode. Second, perform the following key operations depending on the modulation system.

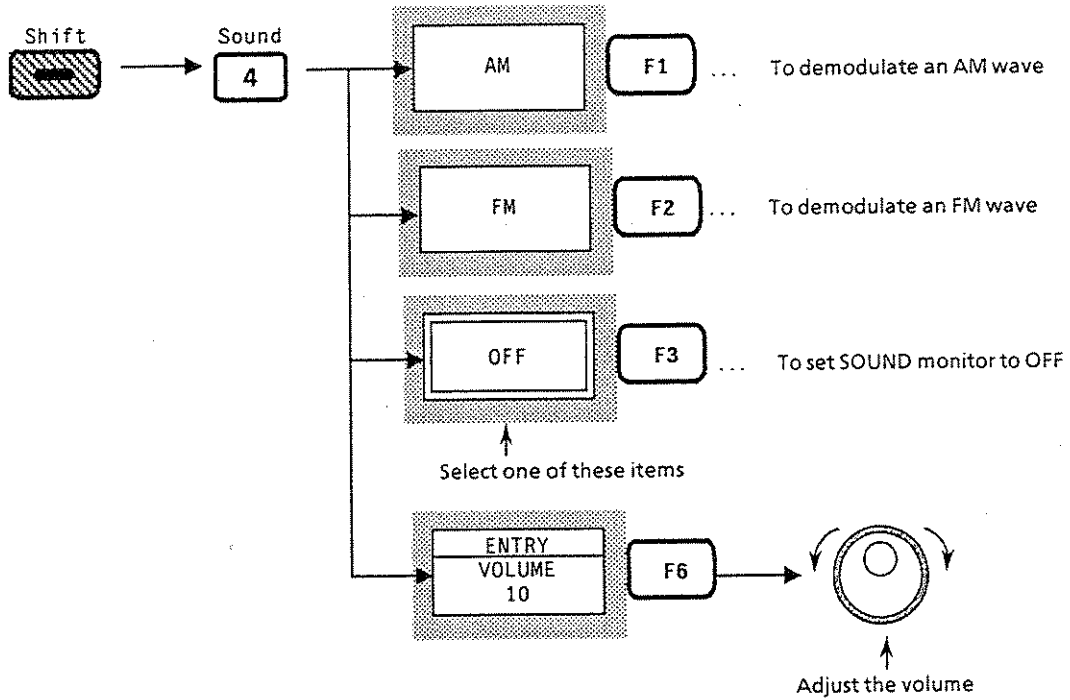

11.4.1 Sound monitor from AM wave

Since the MS2602A is not equipped with an AGC circuit that is used in a general AM receiver, the reference level must first be set to an optimum value depending on the receiving level.

In the time domain display (for linear scale), set the reference level so that the waveform shown below is displayed. The optimum values of both the resolution bandwidth (RBW) and video bandwidth (VBW) are 3 kHz and 10 kHz.

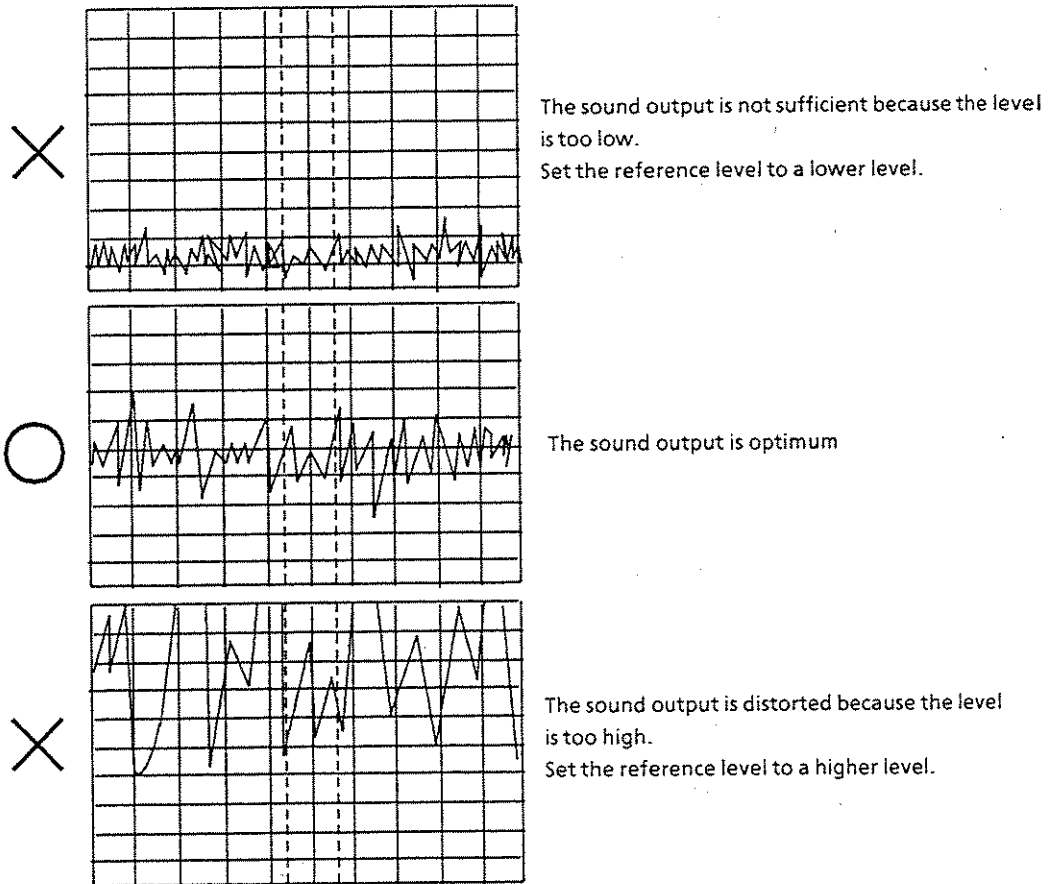

11.4.2 Sound monitor from FM wave

An FM wave is different from an AM wave in that the sound output level is not changed by the input level. When compared to the reference level, a too low input level results in S/N deterioration. Therefore, the input level should be set so that it is preferably equal to the reference level. The resolution bandwidth (RBW) should be set to approximately three times (maximum frequency deviation + maximum modulation frequency).

- ① For FM radio communication RBW = 10 kHz
- ② For FM broadcasts and TV sound broadcasts RBW = 30 kHz

(Blank)

SECTION 12

INTERFACE / PMC

This section describes the interface between the MS2602A and external devices, and the initialization and management of PMC.

TABLE OF CONTENTS

12.1	Interface with External Devices	INTERFACE	12-3
12.1.1	Using GP-IB1 and GP-IB2		12-3
12.1.2	Setting GPIB address		12-4
12.2	PMC		12-5
12.2.1	Selecting media		12-5
12.2.2	Formatting media		12-6
12.2.3	Managing media		12-7

(Blank)

SECTION 12 INTERFACE / PMC

12.1 Interface with External Devices INTERFACE

The MS2602A has two types of external interface GPIB ports: GP-IB1 and GP-IB2. This paragraph describes how to use the two GPIB ports and how to address them.

12.1.1 Using GP-IB1 and GP-IB2

To control the MS2602A as a device from an external controller, the controller and other devices are connected to the GP-IB1 via a GPIB interface cable. To use the MS2602A itself as a controller and control other external devices from the controller (hard copy, external PMC control, other control), the other devices are connected to the GP-IB2 via a GPIB interface cable. Both GP-IB1 and GP-IB2 can also be used simultaneously.

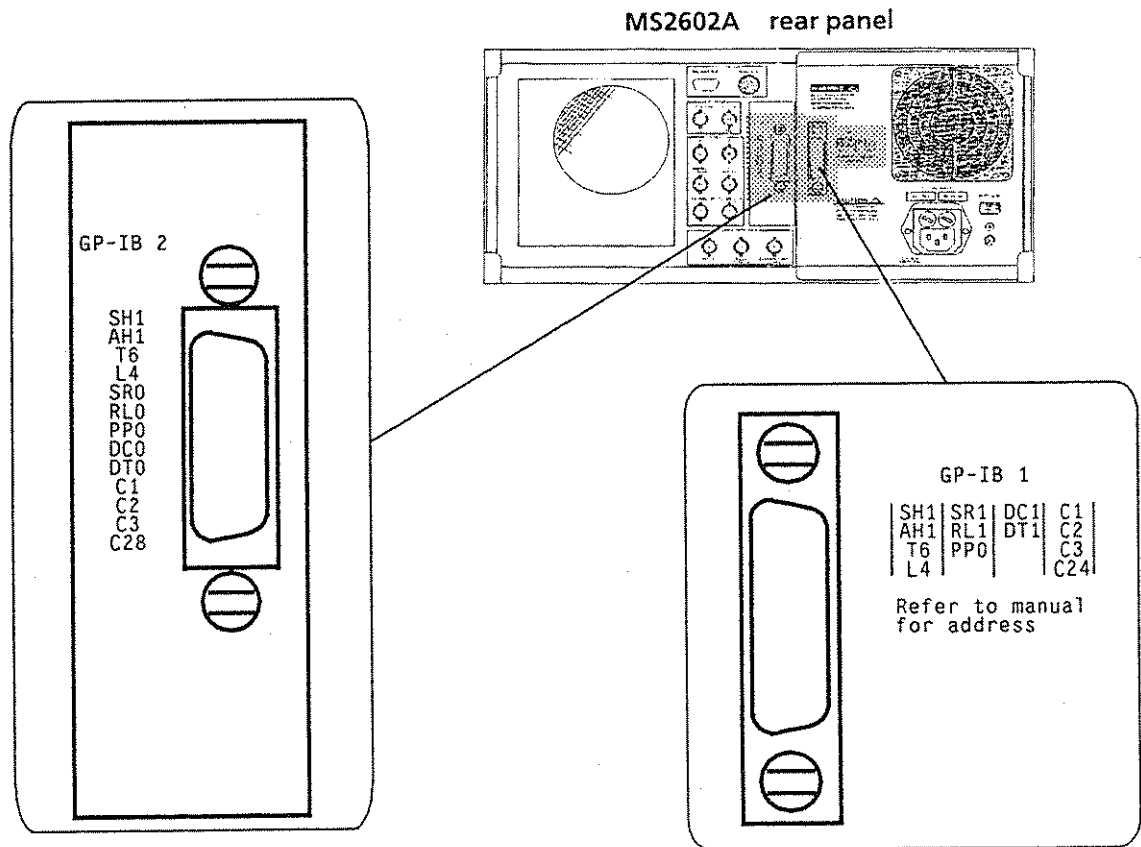

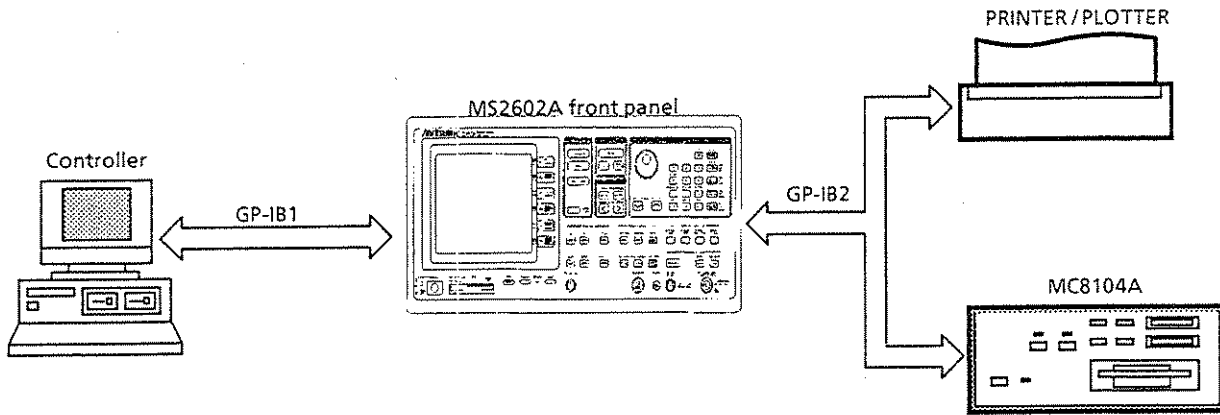

By controlling the MS2602A from the controller via GP-IB1, the measured waveforms and parameters are:

- Output to a printer or plotter.
- Saved to the PMC or floppy disk attached to the MC8104A Data Storage Unit.

12.1.2 Setting GPIB address

To set the GPIB address of each port, perform the following key operations. This addressing also includes how to set the address for outputting data to the MC8104A.

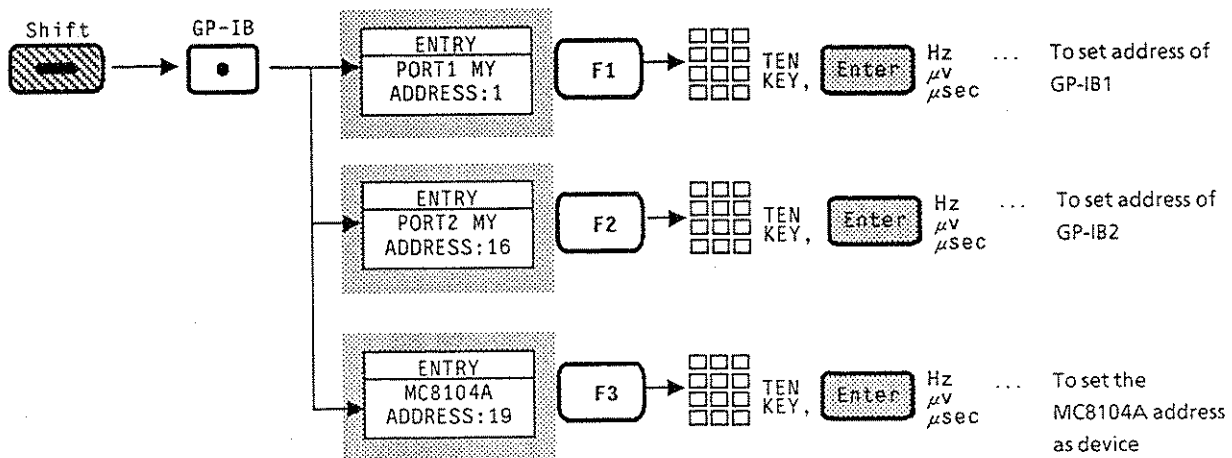
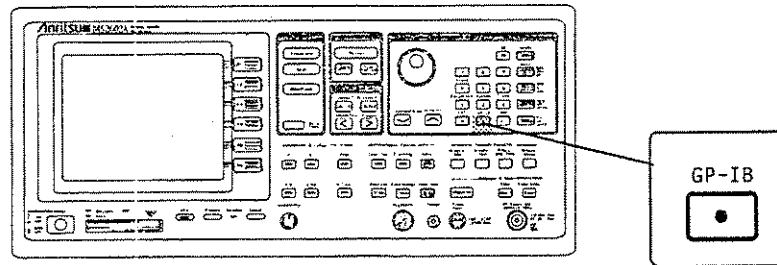

The GPIB address number for each port ranges from 0 to 30.

12.2 PMC

Trace data, measurement parameters, and other data of the MS2602A can be saved to the PMC inserted in the MS2602A main instrument slot or to the PMC or floppy disk inserted in the MC8104A Data Storage Unit connected to GP-IB2. This section explains how to format and manage these media for the MS2602A.

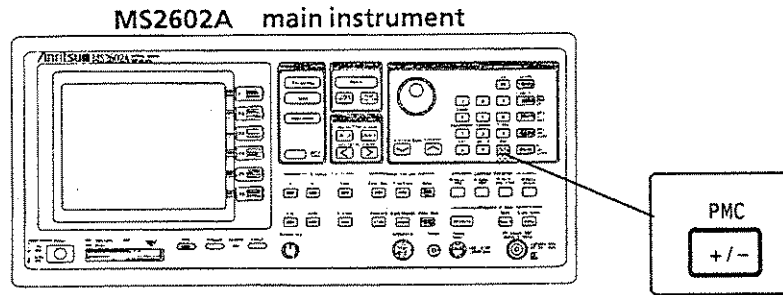

12.2.1 Selecting media

Before formatting and managing media, first select the type of media. To select a media, perform the following key operations.

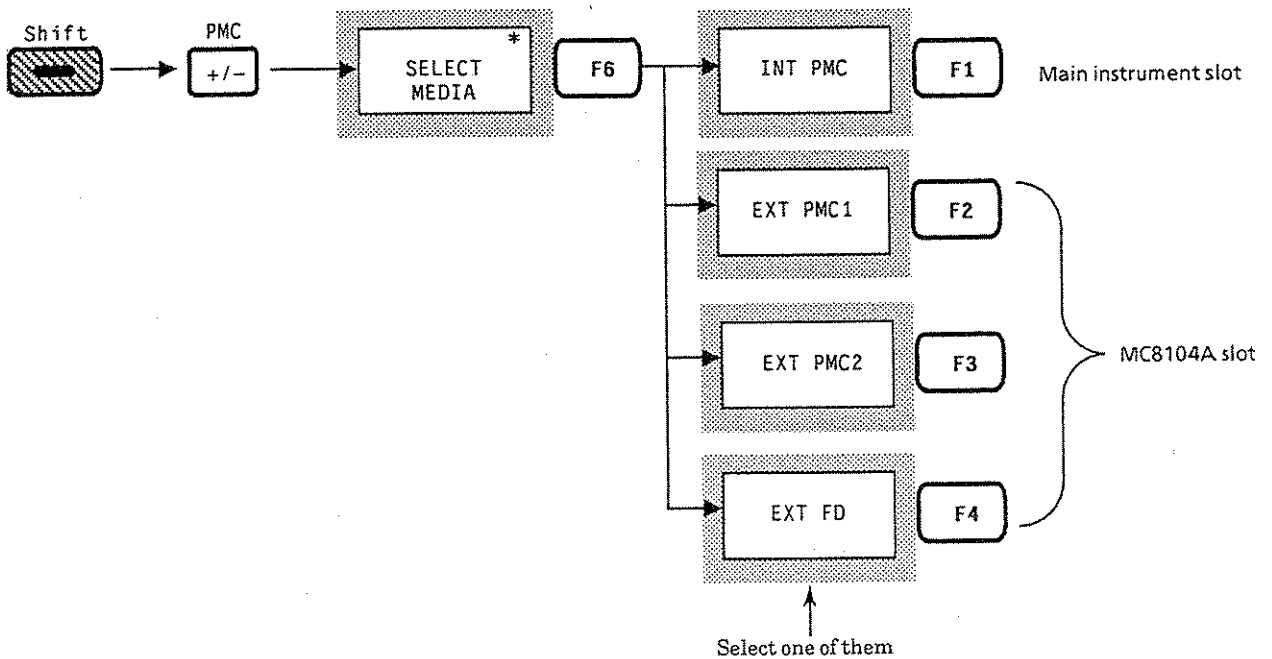

12.2.2 Formatting media

CAUTION

Since formatting media deletes all the contents of the media, check the media contents before formatting.

When PMC or a floppy disk is used initially for the MS2602A, first format the media. To format the media, select the media, then perform the following key operations.

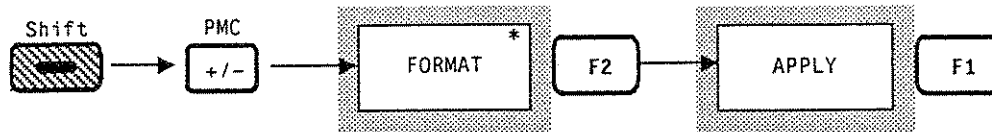

When the formatting is completed, the message 'Formatting completed' is displayed at the lower-right side of the screen.

12.2.3 Managing media

For directory display, write protection, and deletion of files, perform the following key operations.

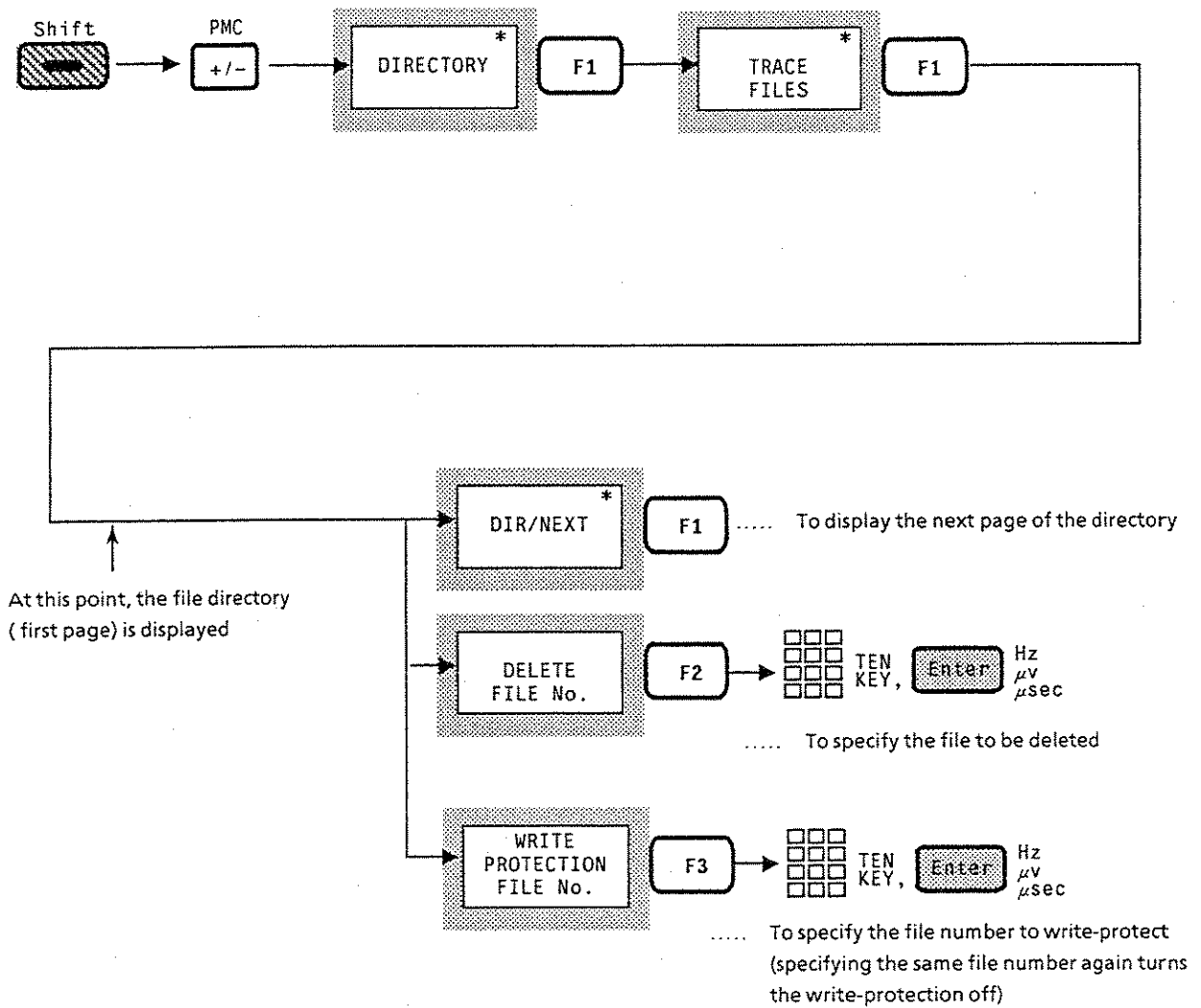

Note: When PMC, floppy disk or file is write-protected, it is impossible to delete the file.

(Blank)

TABLE OF CONTENTS (Continued)

13.7	Measuring Noise Level	13-27
13.7.1	Absolute value measurement of noise power	13-27
13.7.2	Carrier signal vs. noise power measurement	13-28
13.7.3	C / N measurement	13-29
13.8	Occupied Frequency Bandwidth Measurement	13-31
13.8.1	Occupied frequency bandwidth measurement by the X dB DOWN method	13-32
13.8.2	Occupied frequency bandwidth measurement by the N% of POWER method	13-34
13.9	Adjacent-channel Leakage Power Measurement	13-36
13.9.1	Adjacent channel leakage power measurement in which a channel is specified	13-39
13.9.2	Adjacent leakage power measurement in which a graph is displayed	13-42
13.10	Burst Signal Measurement (Go / No-Go Decision by Template Data)	13-45
13.10.1	Outline of template decision	13-45
13.10.2	Template data selection and go / no-go decision	13-46
13.10.3	Creating template data	13-48
13.10.4	Changing template data	13-54
13.10.5	Moving the template	13-56
13.11	Burst Signal Measurement (Average Power Measurement)	13-57
13.12	Setting the Measure Window Display Position	13-59

SECTION 13 MEASUREMENT

13.1 General Precautions on Measurement

The general precaution that should be observed when performing measurement are explained here.

13.1.1 Input signal level range

The table below shows the relationship between the reference level (REF LEVEL) and input attenuator (ATTEN). Usually, the input attenuator is set to AUTO and the most appropriate attenuator value is set automatically according to the reference level setting so that the mixer is not saturated.

Reference Level and Input Attenuator

REF LEVEL (dBm)	AUTO Atten (dB)
+ 25.1 to + 30.0	45
+ 20.1 to + 25.0	40
+ 15.1 to + 20.0	35
+ 10.1 to + 15.0	30
+ 5.1 to + 10.0	25
+ 0.1 to + 5.0	20
- 4.9 to 0.0	15
- 9.9 to - 5.0	10
- 74.9 to - 10.0	5
- 100.0 to - 75.0	0

REF LEVEL (dBm)	MANUAL Atten (dB) *
+ 25.1 to + 30.0	40 to 55
+ 20.1 to + 25.0	35 to 55
+ 15.1 to + 20.0	30 to 55
+ 10.1 to + 15.0	25 to 55
+ 5.1 to + 10.0	20 to 55
+ 0.1 to + 5.0	15 to 55
- 4.9 to 0.0	10 to 55
- 9.9 to - 5.0	5 to 55
- 45.0 to - 10.0	0 to 55
- 50.0 to - 45.1	0 to 50
- 55.0 to - 50.1	0 to 45
- 60.0 to - 55.1	0 to 40
- 65.0 to - 60.1	0 to 35
- 70.0 to - 65.1	0 to 30
- 75.0 to - 70.1	0 to 25
- 80.0 to - 75.1	0 to 20
- 85.0 to - 80.1	0 to 15
- 90.0 to - 85.1	0 to 10
- 95.0 to - 90.1	0 to 5
- 100.0 to - 95.1	0

* The resolution value for setting input attenuator is 5 dB.

13.1.2 Dynamic range

Generally, in spectrum analyzers, the measurable range are restricted by the following elements.

(1) Average noise level

This is the noise generated in the spectrum-analyzer RF section; it is distributed equally across the entire frequency ranges.

(2) Residual spurious

The harmonics etc. of various signals in the spectrum analyzer are mixed together in a complex manner and converted to the IF signal components, which are displayed as a response on the screen. Consequently, it is present whether or not a signal to be measured is input.

(3) Secondary harmonic distortion

When the level of the input signal is high, because of non-linearity in the mixer, spurious of the input signal harmonics is generated.

(4) Two-signal 3rd-order intermodulation distortion

When two adjacent signals with high level are input, intermodulation occurs in the mixer etc. and spurious, which is separated only by the frequency difference of the two signals, is generated above and below the two signals.

The dynamic range is the difference (between the maximum level of the input signal and the maximum level of items (1), (2), (3), and (4) described above) and is represented in dB. The range (which has no effect from items (1), (2), (3), and (4)), is called the dynamic range.

Generally, the average noise level is decreased by 10 dB when the RBW is reduced by 1 / 10. However, when the RBW is reduced, it is also necessary to reduce the sweep speed. For the best measurement efficiency, it is necessary to set the most appropriate RBW.

Secondary harmonic distortion (3) and two-signal 3rd-order intermodulation distortion (4) vary according to the mixer input level. The mixer input level is the input signal level attenuated by the ATT attenuation amount. When the mixer input level is decreased by 10 dB, the secondary harmonic distortion is lowered by 20 dB and the 3rd-order intermodulation distortion is lowered by 30 dB. However, when the ATT attenuation amount is large, since the IF-section gain increases correspondingly, the average noise level also increases. Consequently, in actual measurement, the measurement objective and efficiency must be given careful consideration for setting the RBW and ATT.

The diagram below explains how the input attenuator settings under a constant input signal level affect the dynamic range of the harmonic distortion, residual response, and average noise level.

(The numeric data below is only an example, and is not related to the actual performance of the MS2602A.)

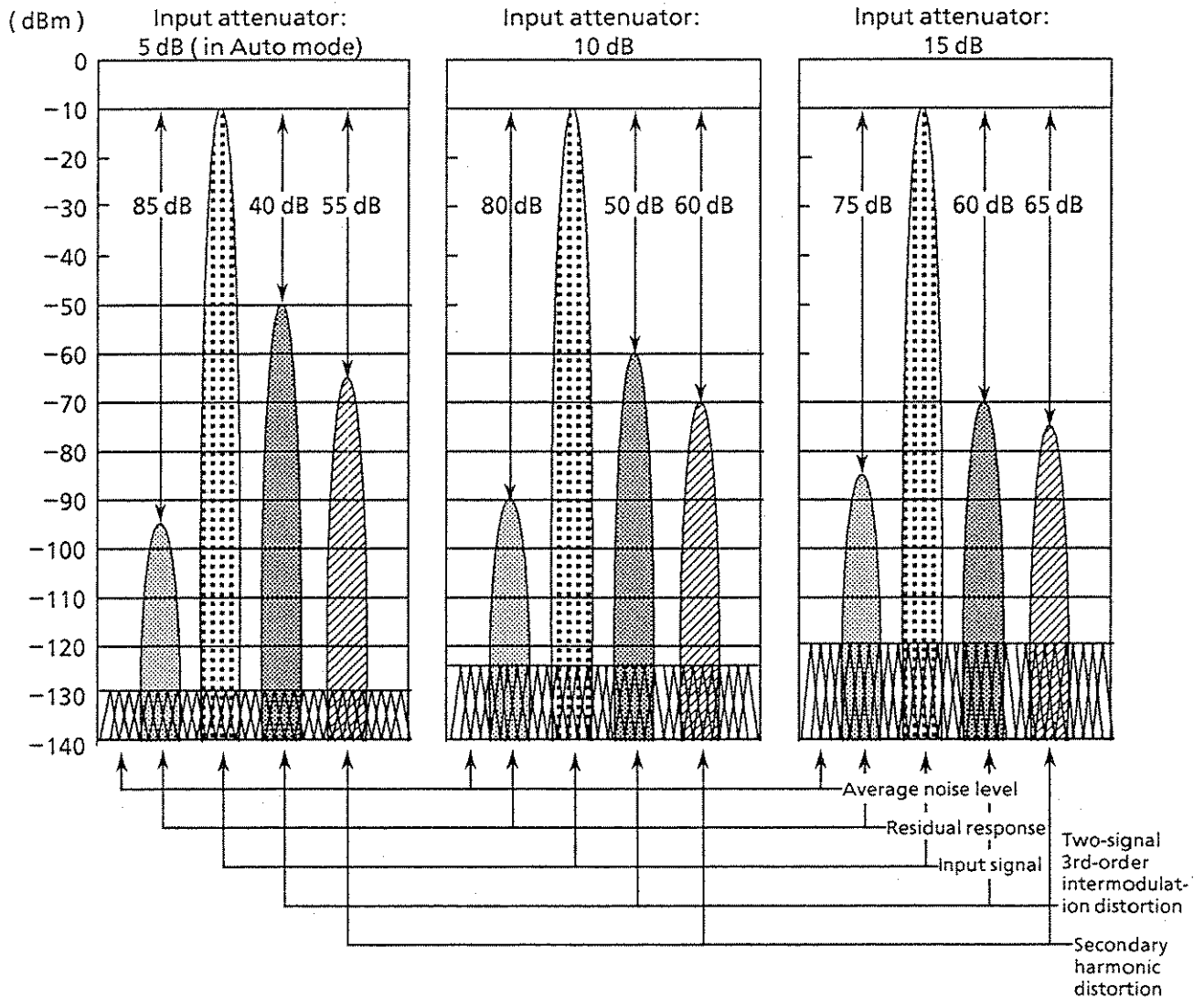

Relationship Between Input Attenuator Settings and Dynamic Range

As shown in the above diagram, the input attenuator in Auto mode is set to Noise Minimum so that the average noise level becomes lower. This indicates that the input attenuator must be higher than that in Auto mode when the dynamic range is required in relation to distortion.

13.2 General Measurement Procedure

The MS2602A general measurement procedure is explained here. The procedure for displaying the spectrum of a signal on the screen is broadly divided into the following two methods.

13.2.1 Auto Tune function

This method is applied when the frequency and level of the signal to be measured are not known and the signal has a higher level than other signals.

Step	Procedure
1	Press the [Preset] key of the MS2602A.
2	Press the [Auto Tune] key. The peak level in the reception bandwidth specified by BG of the A / BG display modes is tuned automatically. <ul style="list-style-type: none"><li data-bbox="204 697 1386 761">• When the level of the signal to be measured is lower than the level of another signal, tune according to the method described in the following paragraph.<li data-bbox="204 778 1386 842">• For more details of the Auto Tune function, see SECTION 4 ' SIGNAL SEARCH FUNCTION ' (page 4-4).

13.2.2 A / BG, Peak → CF, Peak → Ref

These methods allow easy tuning to a signal that cannot be tuned by the Auto Tune function described in the previous paragraph.

Step	Procedure
1	Press the [Preset] key of the MS2602A.
2	Press the [A / BG] key of the Display section.
3	Change the position and width of the zone marker (BG zone) on the trace BG to enclose the signal to be measured. Check that the signal to be measured appears on trace A.
4	Press the [A] key of the Display section.
5	Press the Peak [→ CF] key so that the spectrum of the signal to be measured moves to the center position.
6	Press the Peak [→ Ref] key so that the spectrum peak of the signal to be measured moves to the reference line.
7	Change the frequency span as necessary to magnify or reduce the spectrum.

13.3 Measuring Spurious Harmonics

This paragraph explains the procedure for measuring the level difference of higher harmonic spurious relative to the fundamental signal of a receiver or oscillator.

13.3.1 Measuring fundamental wave and harmonics on the same screen

As the diagram below shows, the fundamental wave and the harmonics can be displayed on the same screen by setting the appropriate frequency range; the level difference of each harmonic wave is measured using the multimarker function. This shows an example of measuring up to the third harmonic wave of a 500 MHz signal.

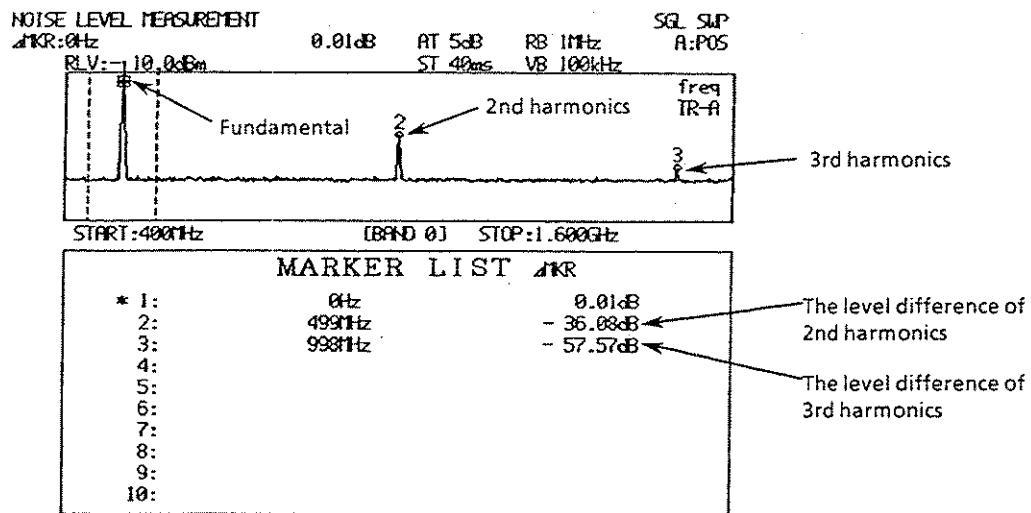

Measuring Fundamental Wave and Harmonics on the Same Screen

Step	Procedure
1	Press the [Preset] key of the MS2602A.
2	Set the start frequency and stop frequency to 400 MHz and 1600 MHz, respectively.
3	Press the [Peak Search] key to move the marker to the peak of the fundamental wave.
4	Press the Peak [→ Ref] key so that the peak of the fundamental wave reaches the reference level.
5	Press the [Marker] [F2: DELTA] key in this order to set the marker to the delta marker mode.
6	Press the [F5: MULTI MKR] key to set the multimarker to ON, then press the [F2: HARMONICS] key to move the marker to the harmonic wave.
7	Read the level difference value of the individual harmonic wave from the marker list.

13.3.2 Measuring low-level harmonics

When measuring low-level harmonics, it is impractical to narrow the RBW to obtain the required sensitivity, because it takes too long for the fundamental wave and harmonics to appear on the same screen. For this reason, generally, the span is narrowed and measurement is made by tuning to each harmonic. However, in the case of the MS2602A, the fundamental and harmonics can be displayed simultaneously while only the harmonics are measured at high speed by using the zone sweep function. Both methods are explained here using the previous measurement example for the harmonics of a 500 MHz signal.

(1) Measurement precautions

- Since the signal passes through a preselector when the frequency to be measured is between the 1⁻ and 1⁺ bands, execute AUTO TUNE for the preselector (see page 8-6) each time the frequency is changed.
- When the harmonic is tuned, in the case when the reference level and RBW are changed to make measurement of the level easy, fix the input attenuator value in manual mode and do not change it. In addition, see paragraph 13.1 for the relationship between the harmonic dynamic range and noise level.

(2) General measurement method

Step	Procedure
1	Press the [Preset] key of the MS2602A.
2	Set the frequency span to 10 kHz.
3	Press the [Auto Tune] key, and the fundamental wave is tuned automatically and the zone marker is displayed.
4	Set the input attenuator value so that the required dynamic range can be obtained. (For the relationship between input attenuator and harmonic dynamic range, see the diagram on page 13-5.)

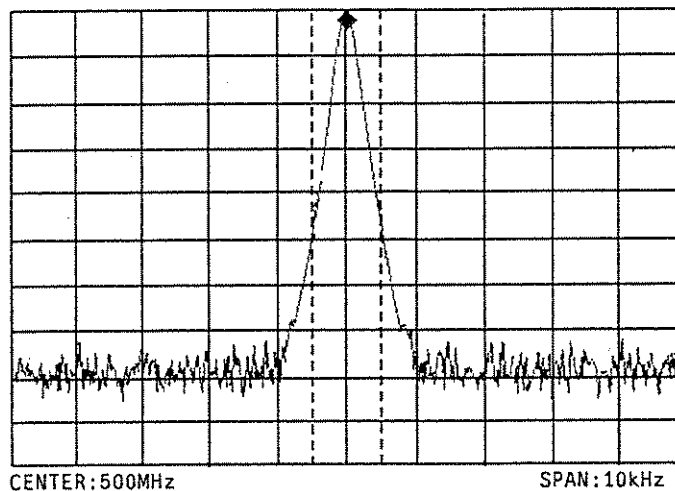

**Low-Level Harmonic Wave Measurement
(Fundamental Wave)**

Step	Procedure
5	Press the [Marker] [F4: MKR →] [F3: MKR → CF STEP] key in this order to set the frequency step size to the same value as the marker frequency.
6	Press the [Marker] [F2: DELTA] key in this order to set the marker to the delta marker mode.
7	Press the [frequency] key to set the entry mode to the center frequency, then press the Step [^] key once; the center frequency is set to approximately 1 GHz and the second harmonic is tuned. Read the level difference of the marker.
8	Press the Step [^] key once more, and the center frequency is set to approximately 2 GHz and the third harmonic is tuned. Read the level difference of the marker.

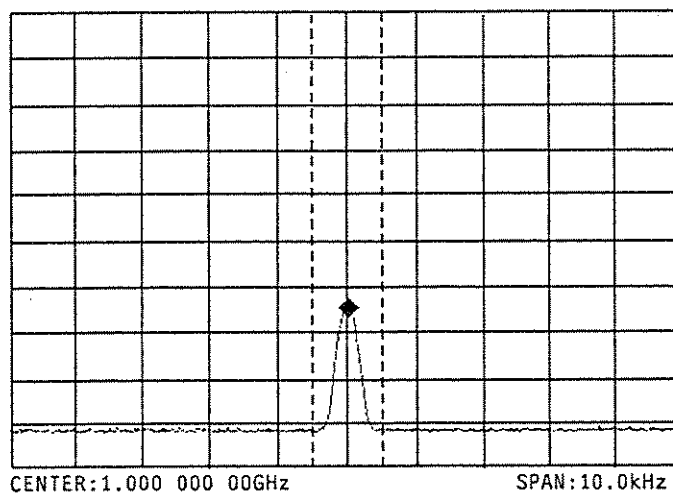

Low-Level Harmonic Wave Measurement
(Second Harmonic)

(3) Measurement using zone sweep

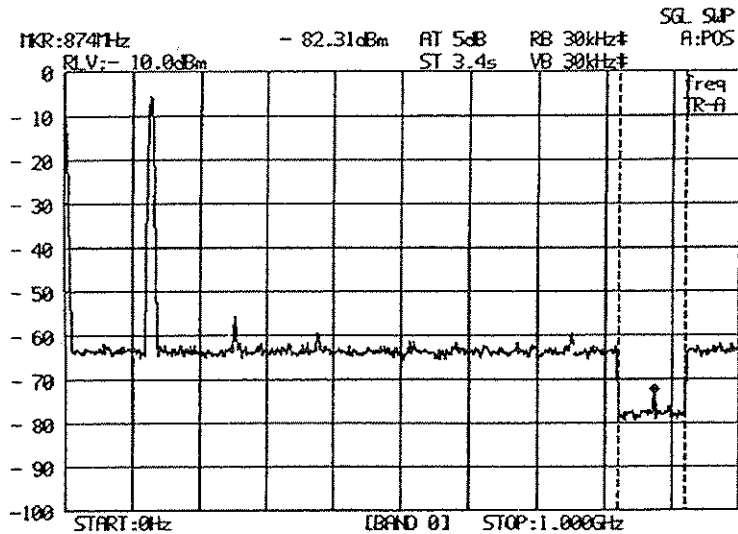

Measuring Harmonics Using Zone Sweep

(At zone sweep - ON,
measure with narrow
RBW.)

Step	Procedure
1	Perform measurement according to the method described in paragraph 13.3.1 with the fundamental wave and harmonics displayed on the same screen. Match the ZONE MARKER to the harmonic. At this time, when the level of the harmonic is low, narrow RBW to reduce the noise level.
2	Press the [Zone Swp] key, then the ZONE SWEEP to ON. Only the ZONE MARKER region is swept so the sweep time becomes shorter in comparison to the full sweep and the harmonic components can be measured quickly.

13.4 Measuring Modulated Waves

In any of the AM, FM or pulse modulated waves, a sideband spectrum is distributed above and below the carrier wave. Consequently, almost the same procedure can be used to enlarge and display the spectrum on the screen and to perform measurement as that for measuring harmonic distortion.

13.4.1 Measuring AM modulation factor

(1) Measuring AM wave in LOG mode

When the spectrum of an AM wave is being measured in LOG mode, the carrier frequency f_c , the modulation frequency f_m , the carrier level P_c , and the single-sideband-wave level P_1 (dBm or dB μ) can be measured as the diagram shows.

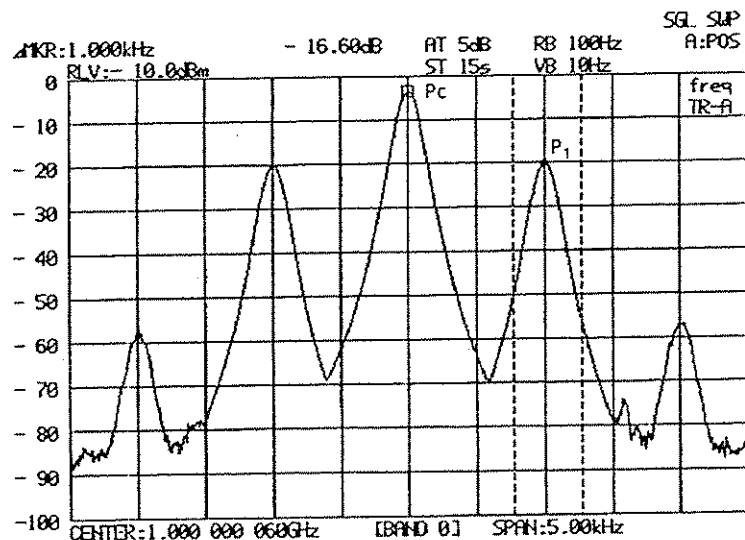

Spectrum of AM Wave (LOG Mode)

The modulation factor m is calculated from the difference ($P_1 - P_c$) between the levels of the carrier wave and single sideband wave using the equation:

$$20 \log (m / 2) = P_1 - P_c$$

This relationship is shown in the diagram on the next page. The level difference ($P_1 - P_c$) is measured easily by using the delta marker.

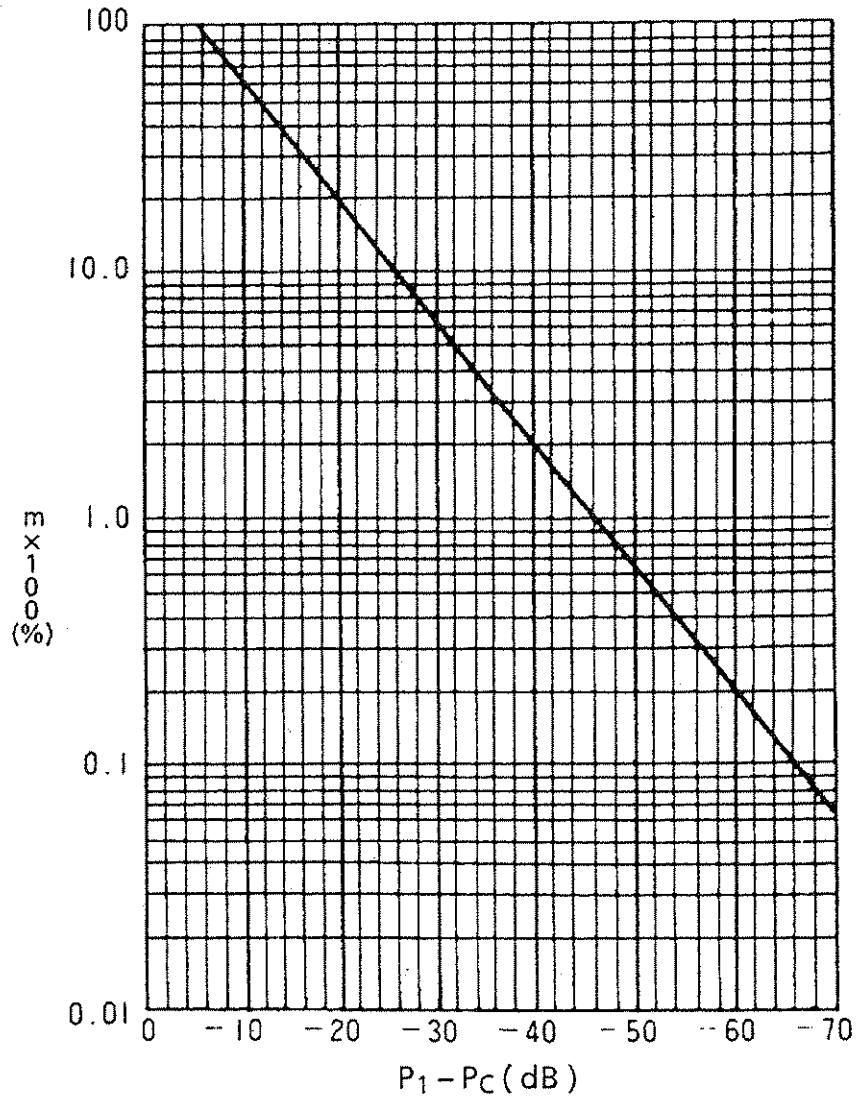

Modulation Factor m and Single Sideband Wave Level (dB)

(2) Measuring AM wave in LIN mode

The carrier wave level P_c and the single sideband level P_1 (volt) can be measured in the LIN mode as shown in the diagram.

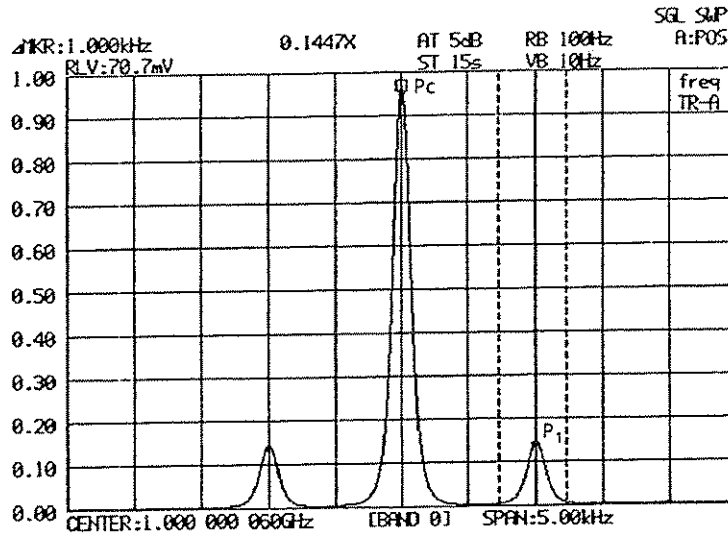

Spectrum of AM Wave (LIN Mode)

The modulation factor m is calculated from the level ratio of the carrier wave to single sideband wave using the equation:

$$m / 2 = (\text{single-sideband-wave level } P_1) / (\text{carrier-wave level } P_c)$$

The level ratio of the carrier wave to single-sideband wave can be measured easily using the delta marker. At LIN scale, the delta marker gives the level ratio between the reference marker and the current marker. Consequently, the modulation factor m can be found from the equation below when the delta marker reading is d .

$$m = 2 \times d \times 100 (\%)$$

(3) Measuring AM wave at time domain

When the modulation frequency is low and the sideband wave cannot be resolved on the frequency axis, the AM modulation factor can be measured by using the time domain.

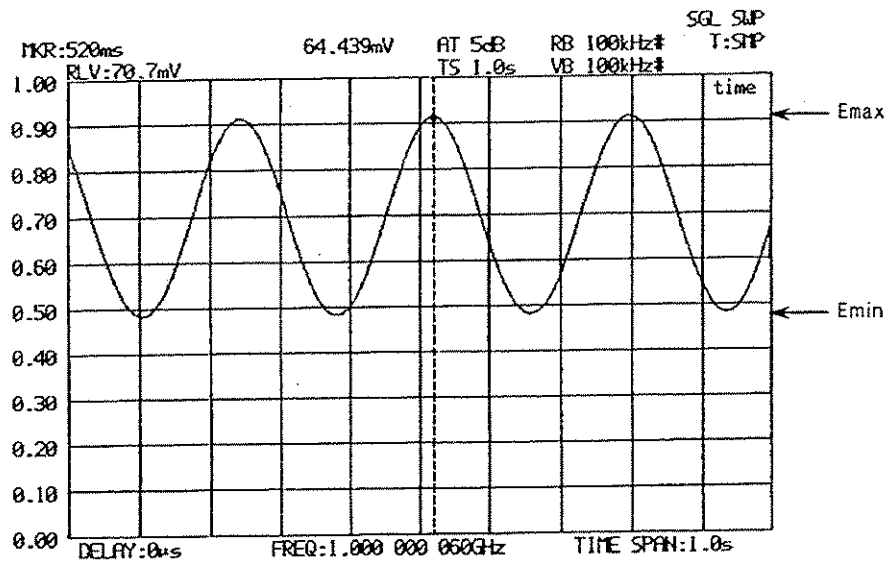

Measuring AM Wave at Time Domain

As the diagram above shows; the maximum value E_{max} , and the minimum value E_{min} , of the demodulated waveform can be measured in LIN mode. The modulation factor m is calculated from E_{max} and E_{min} using the equation:

$$m = (E_{max} - E_{min}) / (E_{max} + E_{min})$$

E_{max} and E_{min} can be obtained easily using the PEAK search and MIN search functions of marker.

13.4.2 FM peak deviation

(1) Measuring FM peak deviation at frequency domain

When the spectrum of an FM wave is displayed as shown below, the carrier frequency f_c , modulation frequency f_m , and the level of each sideband spectrum can be measured.

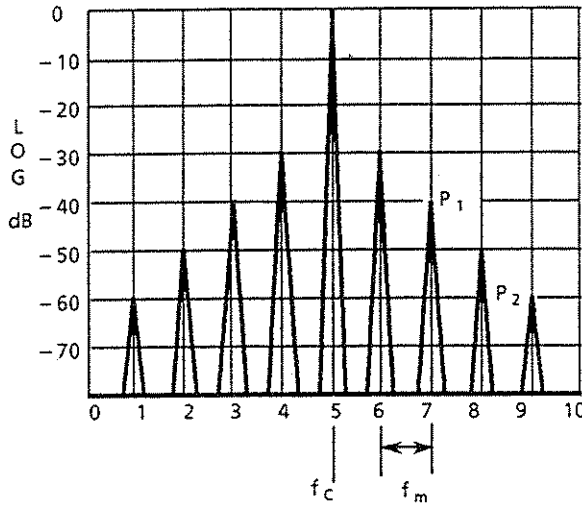

(a) Spectrum interval = f_m

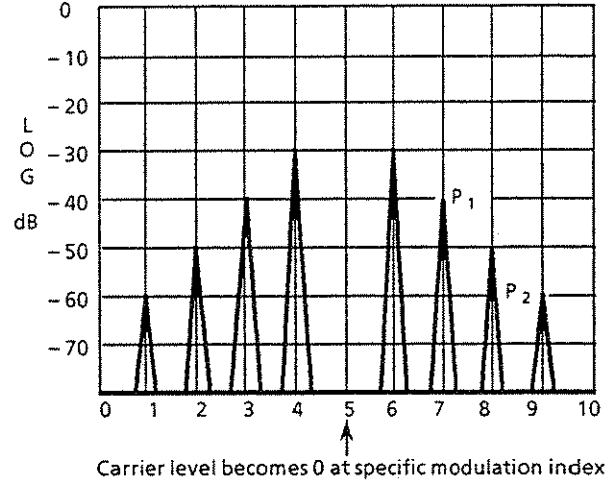

(b) Setting peak deviation by using carrier zero-suppression method

Example of FM Spectrums

The carrier level and sideband level changes according to the modulation index m_f as shown by the Bessel function curves below. The $j_0(m_f) = 0$, $j_1(m_f) = 0$ table shows the modulation indexes when the carrier wave and first sideband wave become zero-level.

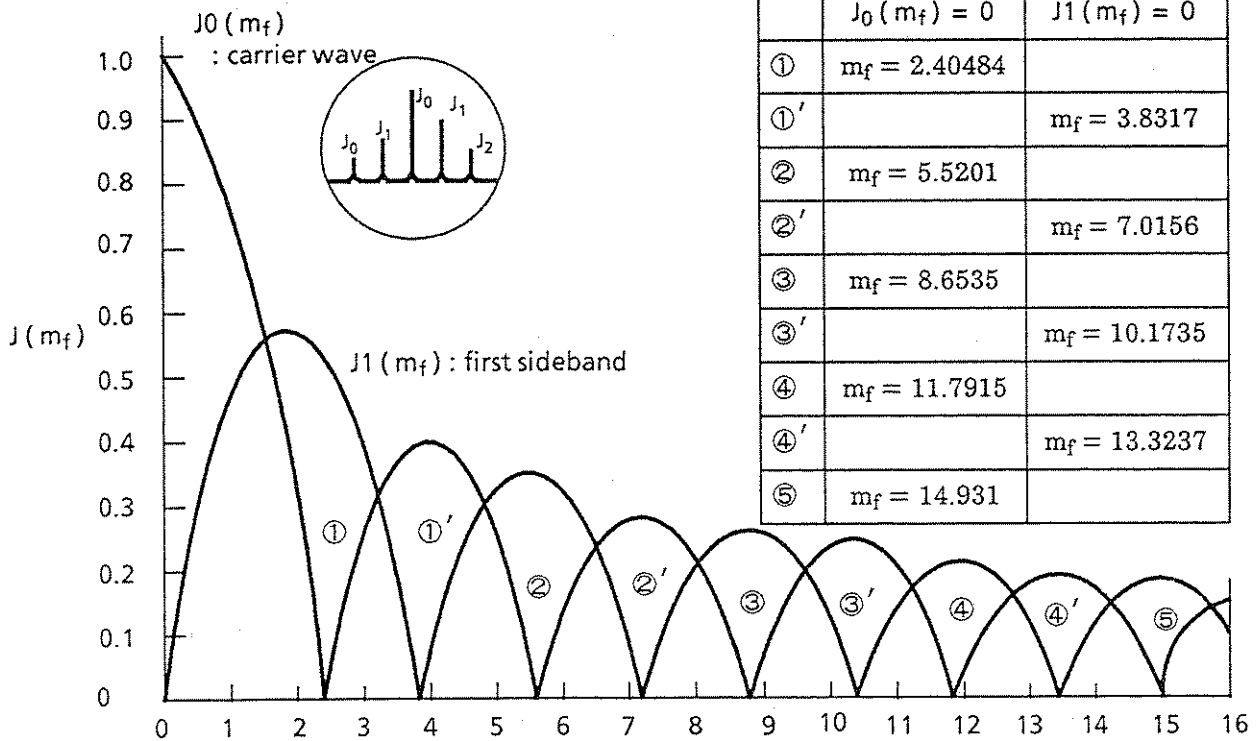

Bessel Functions $j_0(m_f)$, $j_1(m_f)$

Measurement of the FM frequency deviation by determining the modulation index m_f with which the carrier wave becomes zero-level is called the 'carrier zero-suppression method.'

The modulation index m_f is changed by increasing and decreasing modulation signal input level to FM signal generator. The modulation frequency f_m , modulation index m_f , and the peak deviation Δf are related as follows:

$$\Delta f = m_f \cdot f_m$$

The diagram below shows the setup for measuring the frequency deviation of an FM transmitter. The modulation frequency f_m is monitored with a counter and m_f is adjusted by the audio-oscillator output level.

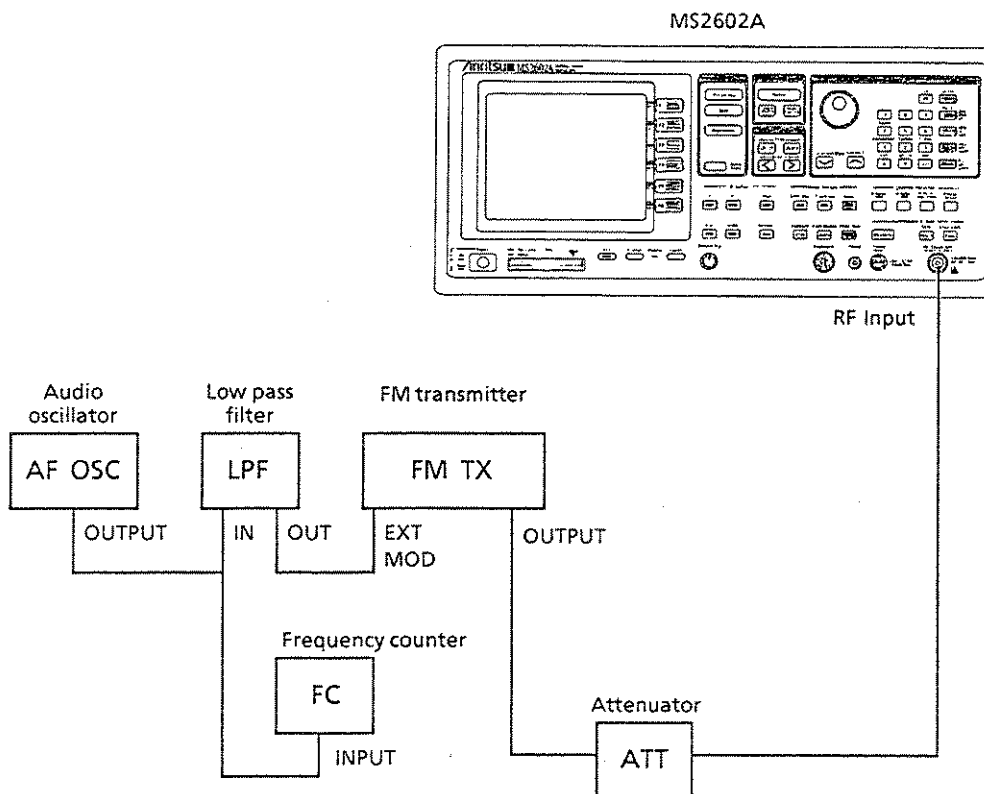

Frequency Deviation Measurement Setup

The relationship between the residual component of the carrier level at the Bessel function curves and the frequency-deviation calibration accuracy is shown in the table on the next page. For example, to attain a $\pm 0.2\%$ calibration accuracy at first time for CW (carrier-wave level) = 0, CW must be attenuated to the -52 dB value shown in () in the table. The frequency deviation at this point becomes:

$$2.40484(1 \pm 0.002) \times f_m = 2.40484 f_m \pm 4.80968 \times 10^{-3} f_m$$

Frequency Deviation Calibration Accuracy

		Calibration accuracy →	± 0.2%	± 0.5%	± 1%
Residual components	CW = 0 (first time) 2.40484 rad	0.00250 † (-52 dB)	0.00663 (-43.6 dB)	0.0124 (-38.1 dB)	
	CW = 0 (second time) 5.52009 rad	0.00374 (-48.6 dB)	0.00937 (-40.6 dB)	0.0187 (-34.6 dB)	
	CW = 0 (third time) 8.6535 rad	0.00468 (-46.6 dB)	0.0117 (-38.6 dB)	0.0233 (-32.7 dB)	
	CW = 0 (fourth time) 11.7915 rad	0.00515 (-45.8 dB)	0.0138 (-37.2 dB)	0.0271 (-31.3 dB)	
	CW = 0 (fifth time) 14.9301 rad	0.00615 (-44.2 dB)	0.0154 (-36.3 dB)	0.0306 (-30.3 dB)	

† $20 \text{ LOG } 0.0025 = -52 \text{ dB}$

As one example, at the measurement setup shown on the previous page, the table below shows the modulation frequency when the carrier wave level becomes 1st, 2nd, 3rd time etc. for frequency deviation of 9 kHz, 3 kHz and 900 Hz using the carrier zero-suppression method.

Modulation Frequency and FM Deviation for Carrier Zero

		Frequency deviation →	9 kHz	3 kHz	900 Hz
Modulation frequency	$J_0(m_f) = 0$ (CW = 0)	First time	3742.5 Hz	1247.5 Hz	374.3 Hz
		Second time	1630.4 Hz	543.5 Hz	163 Hz
		Third time	1040 Hz	346.7 Hz	104 Hz
		Fourth time	763.3 Hz	254.4 Hz	76.3 Hz
		Fifth time .	602.8 Hz	201 Hz	60.3 Hz

(2) FM peak deviation measurement at time domain

By using the FM monitor function at time domain, the FM peak deviation can be measured on the time axis.

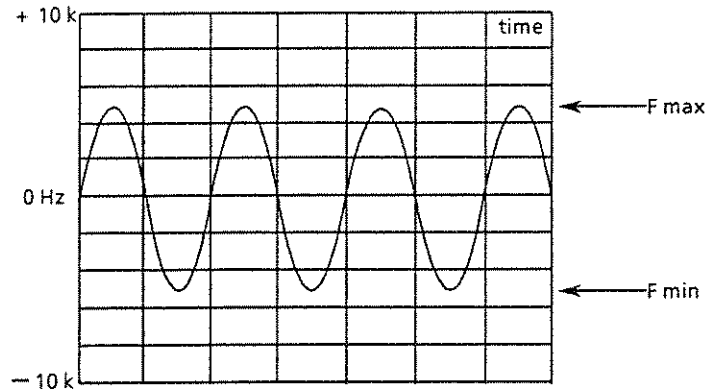

FM Peak Deviation Measurement on Time Axis

As shown in the diagram, where the horizontal and vertical axis are time and frequency respectively, the maximum value F_{max} , and the minimum value F_{min} , of the demodulation waveform can be measured. The peak deviation ΔF can be calculated from F_{max} and F_{min} using the equation:

$$\Delta F = \frac{F_{max} - F_{min}}{2}$$

F_{max} and F_{min} can be obtained easily from the Peak search and Min Dip Search functions of the marker.

13.4.3 Pulse modulated wave

The diagrams below show a pulse modulated wave observed in the time domain and frequency domain. The carrier frequency is shown by f_c , the pulse repetition period by T , and the pulse width by t . When this signal is changed to the frequency domain, the spectrum envelope is shown by $y = (\sin x) / x$. However, since the phase cannot be detected with a spectrum analyzer and the reception frequency varies with time, the appearance of the spectrum varies according to the spectrum analyzer resolution bandwidth and pulse period T . Generally, when the relationship is as shown below, the frequency spectrum shown as the envelope indicated by the dotted line in the diagram can be measured.

$$\begin{aligned} 1/T &< \text{RBW} \\ t \times \text{RBW} &< 0.1 \end{aligned}$$

The total number of spectrums comprising the envelope becomes equal to the number of pulses per sweep; this number changes according to the spectrum-analyzer sweep time. The parameter values f_c , t , and T are found from the spectrum interval and envelope as shown below.

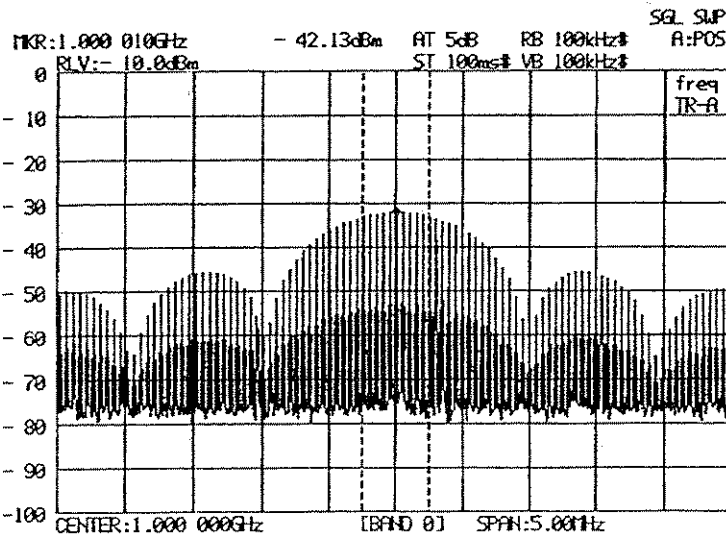
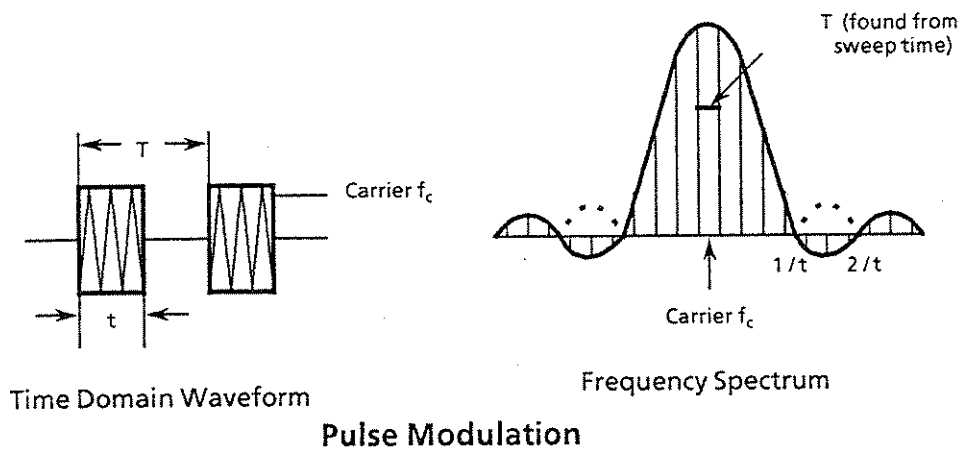

Example of Frequency Spectrum of Pulse Modulated Waveform

In the digital display type spectrum analyzer, the pulses always comes to exist during the sampling time when the pulse repetition period becomes fast. However, each individual pulse becomes invisible.

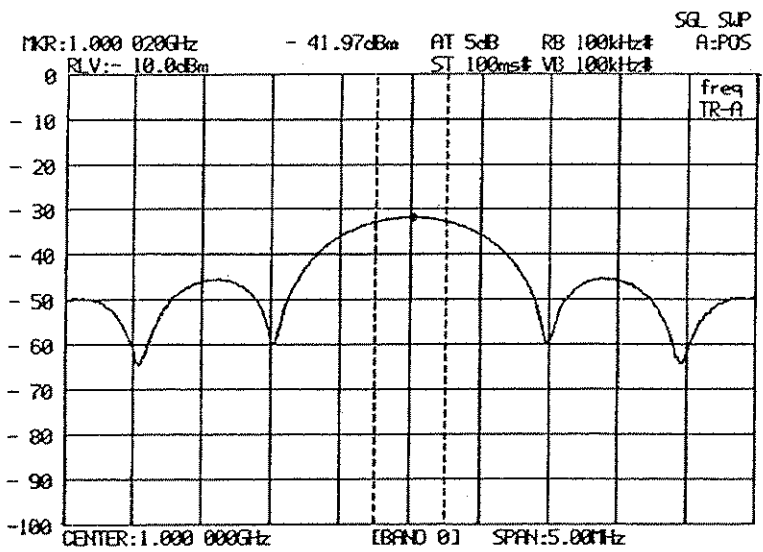

Pulse width: approx. 1.0 μ sec
 Pulse period: approx. 0.1 msec

Example of Frequency Spectrum Measurement of Pulse Modulated Wave

In this case, since the time domain of the MS2602A allows the sampling time to go down to 100 nsec, it is possible to observe the pulse modulated waveform on the time axis.

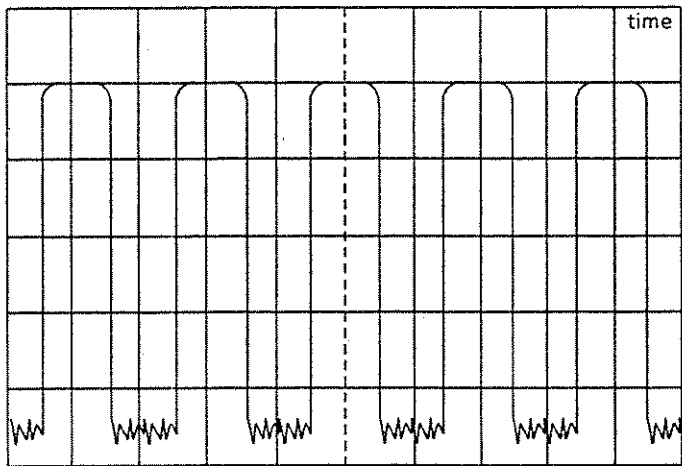

Example of Pulse Modulated Wave Measurement at Time Domain

13.5 Measuring Intermodulation Distortion

When two or more large-level signals are input to a device such as an amplifier, these signals are intermixed and generate signals other than the original signals. This is called intermodulation distortion. The signals generated by intermodulation distortion appear as signals that are separated from the original signals by the frequency difference of the original signals. The level of this intermodulation distortion depends on the levels and frequencies of the input signals. When two signals are input, the distortion is observed as 3rd-order distortion, and when the input signal level is decreased by 10 dB, the distortion decreases by 30 dB. The diagram below shows this relationship; the point (where the input signal crosses the distortion component) is called the intercept point.

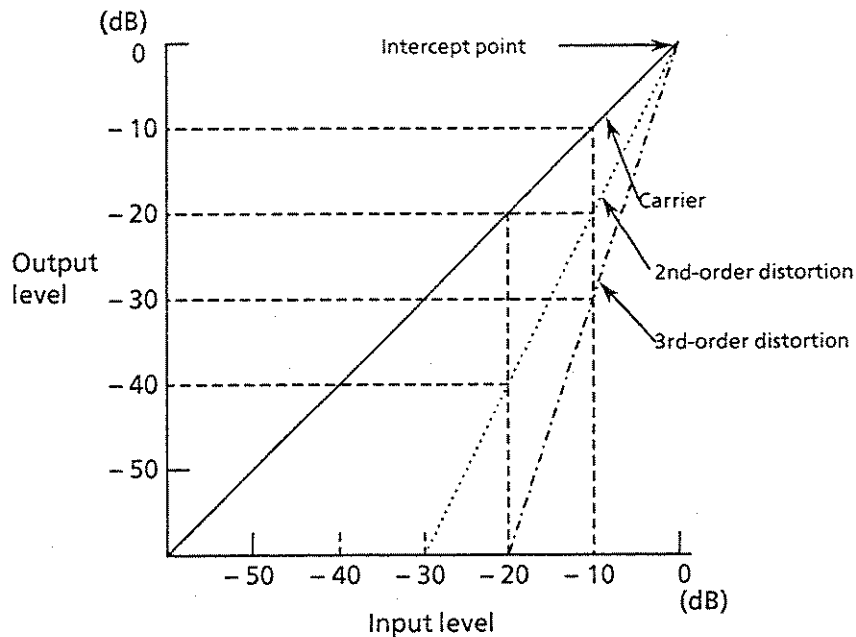

Harmonic Distortion and Input Level

The diagram below shows the setup when measuring the intermodulation distortion of a device such as an amplifier with a spectrum analyzer. Intermodulation distortion is even generated in the spectrum analyzer and this distortion component is determined by the mixer input level. Consequently, when measuring intermodulation distortion using a spectrum analyzer, it is necessary to take care about the mixer input level. At this time, it is possible to determine whether or not the DUT or the spectrum analyzer is generating the distortion by whether or not the distortion component changes when the spectrum analyzer input attenuation value is varied.

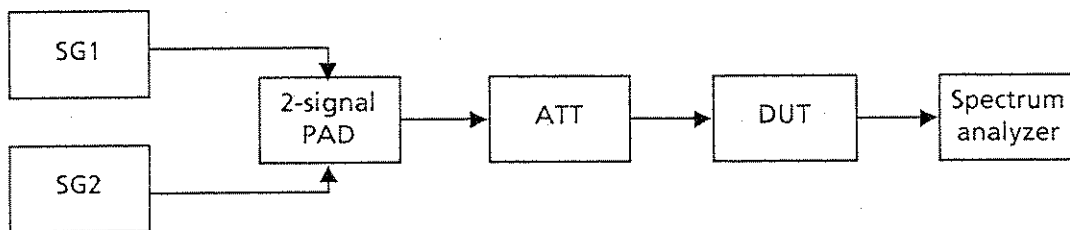

Intermodulation Distortion Measurement Setup

When the spectrum analyzer is generating the distortion, the distortion component changes by 15 dB when the input attenuation is varied by 5 dB. Consequently, in this case, it is necessary to increase the attenuation of the input attenuator to the point where the distortion does not change.

In addition, when two signals are input to the DUT, the two signal generators cause mutual interference and intermodulation distortion occurs. To distinguish this, confirm whether or not the distortion changes by a factor of 3 relative to the attenuation value when the attenuator in front of the DUT is varied. When the distortion component does not change by a factor of 3, insert an isolator between the 2-signal pad and the signal generators to prevent intermodulation distortion being caused by the signal generators.

13.6 Measuring Frequency

The simple way to measure the frequency by the spectrum analyzer is to read out the marker frequency described previously in SECTION 3, MARKER FUNCTION. However, since in addition to the reference frequency error, this includes the errors of span linearity and IF filter center frequency, it is impossible to measure the frequency accurately.

Since the MS2602A incorporates a frequency counter, it is possible to measure the frequency with the same accuracy as the reference frequency.

To measure the frequency accurately, first move the marker to the peak of the signal to be measured, then perform the following key operations.

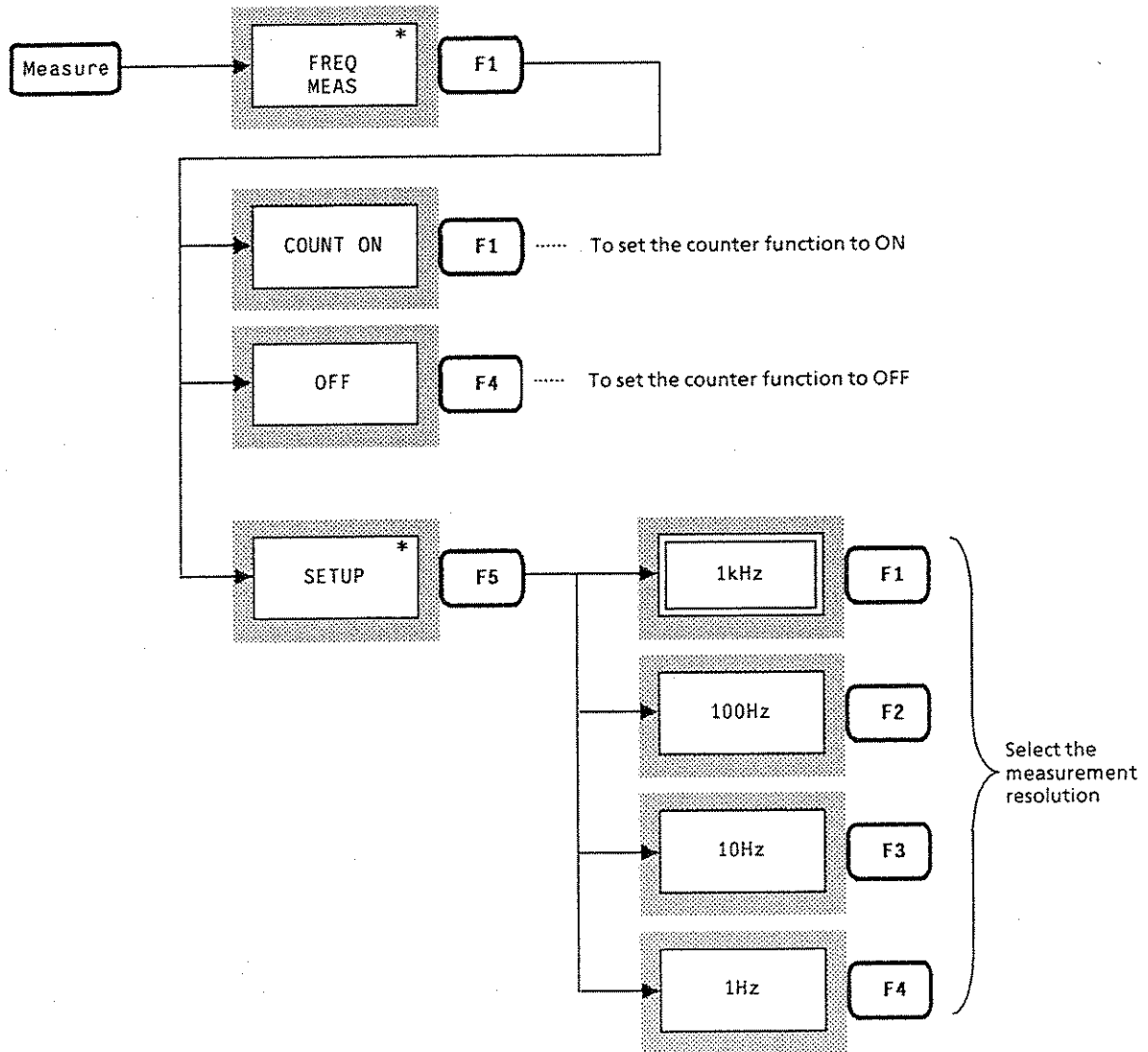

The frequency is measured every time the sweep is completed, and the measured result is displayed in the measure window at the upper-right corner of the graticule.

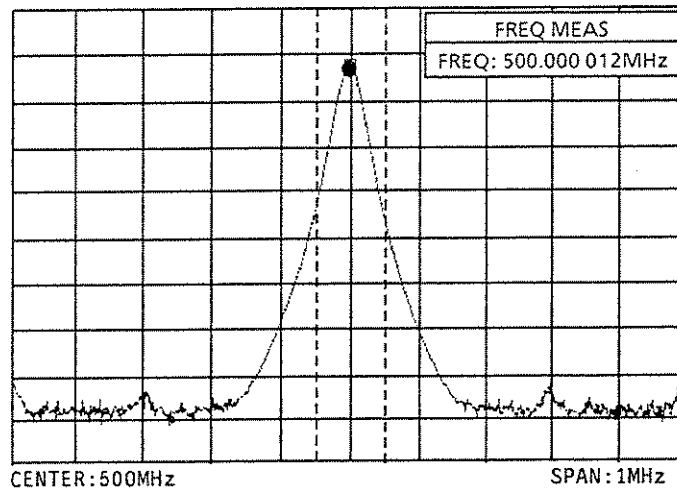

Notes: *The count operation is performed every time each sweep is completed.*

The frequency counter function does not operate during marker OFF or while $A < BG$ in the A / BG mode.

A too narrow resolution width in comparison with the frequency span incurs a longer measurement time because automatic tuning is made internally and then the frequency is counted.

Since the following cases are affected by noise and adjacent interference waves, miscounting may occur.

- *Signal level is -30 dB or less than the reference level*
- *The level difference between the signal level and noise level is 20 dB or less*

13.7 Measuring Noise Level

The MS2602A can measure the noise level for any bandwidth as an absolute-value power or as value relative to a carrier signal.

13.7.1 Absolute value measurement of noise power

To measure the absolute value of noise power, perform the following key operations.

- ① Set the marker mode to the normal marker to move the marker to the frequency to be measured.
- ② Set the zone marker width to the noise bandwidth to be measured.
If the zone marker is set to the spot marker, then the noise level per 1 Hz is measured.
- ③ Perform the key operations below; the noise measurement starts to measure at each sweep; the measured noise level value is displayed in the measure window in the upper right-hand corner of the graticule.

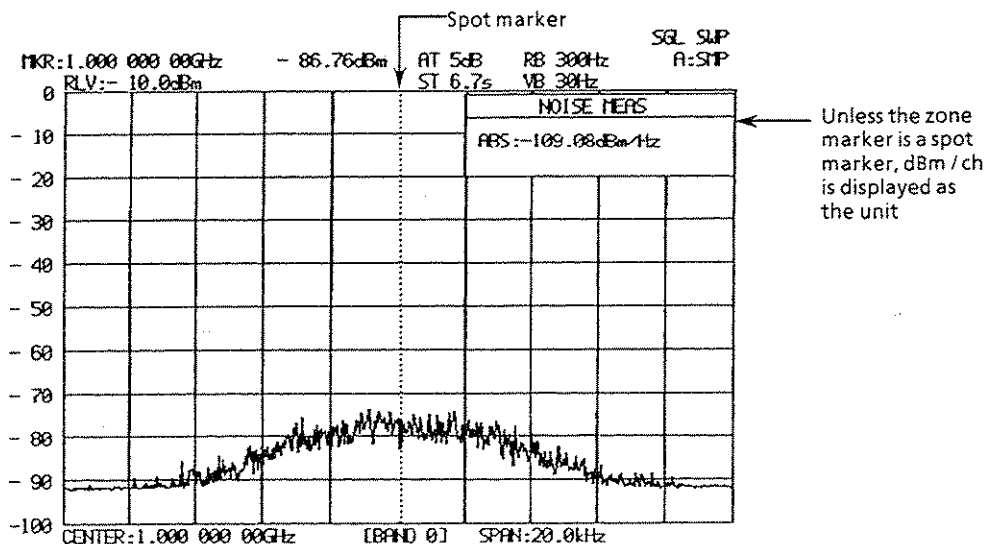
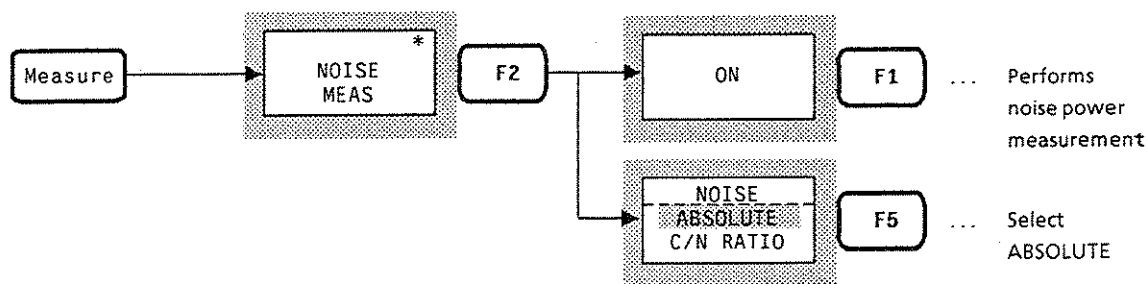

- Notes:**
- When the scale is set to linear scale, the noise is not measured.
 - The unit of the measured result is dBm / Hz or dBm / ch, irrespective of the reference level unit.
 - The noise must be measured with the detection mode set to SAMPLE.

13.7.2 Carrier signal vs. noise power measurement

To measure the noise power in comparison with the carrier signal level, perform the following key operations.

- ① Set the marker mode to the normal marker to move the marker to the peak point of the signal to be measured.
- ② Set the marker mode to the delta marker.
- ③ Set the zone marker width to the noise bandwidth to be measured, then move the zone marker center to the frequency at the noise measurement point. If the zone marker is set to the spot marker, then the noise level per 1 Hz is measured.
- ④ Perform the key operations below; the noise measurement starts to measure at each sweep; the measured noise level value is displayed in the measure window in the upper right-hand corner of the graticule.

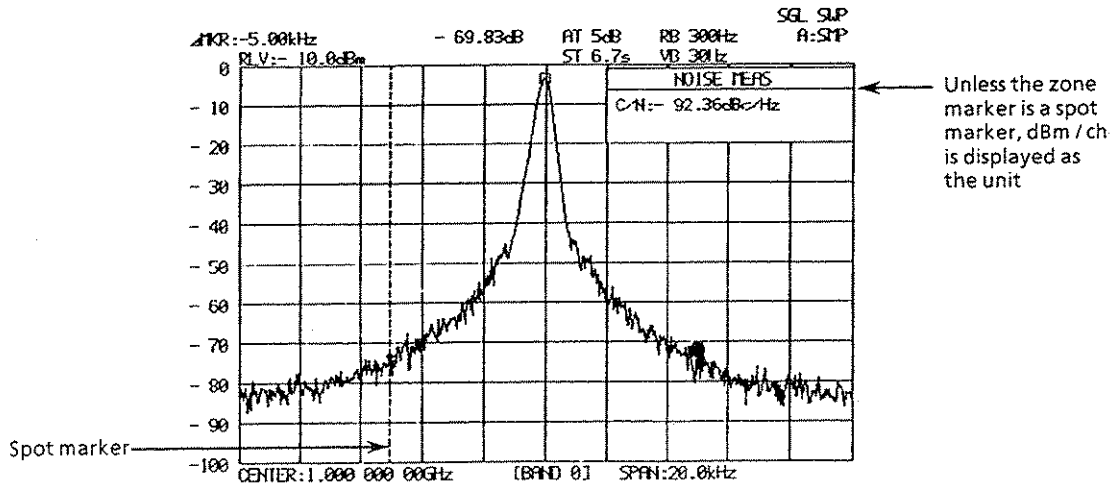
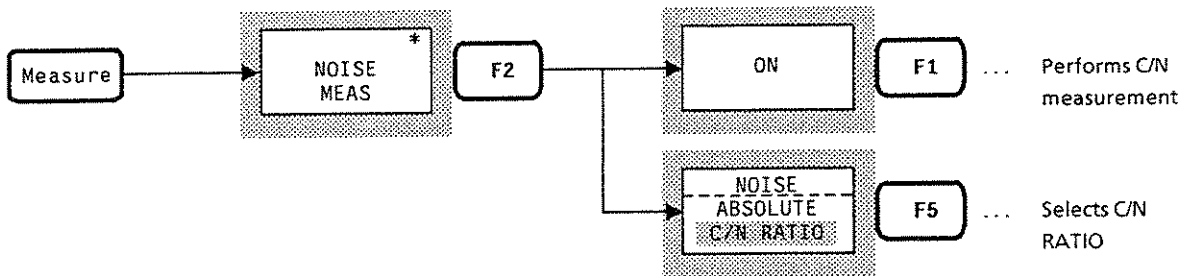

Notes: When the scale is set to linear scale, the noise is not measured. The unit of the measured result is dBc / Hz or dBm / ch, irrespective of the reference level unit.

The noise must be measured with the detection mode set to SAMPLE.

In this measurement, the level difference value when the normal and reference markers overlap each other by moving the marker frequency to the reference marker (the peak point of the carrier signal) is not always 0 dB. This is because a detection correction value is added to the carrier signal with the reference marker as a noise.

13.7.3 C/N measurement

An actual example of measuring the sideband noise of the signal using the noise measurement function of the MS2602A is given below.

The output signal from equipment such as a signal generator is not a pure sine wave, and besides the harmonic wave, it includes noise of amplitude components and frequency components. These are generally called AM noise and FM (phase) noise. Generally, the AM noise is a lot smaller in comparison to the FM noise so measurement of FM noise is explained here.

The FM noise exists just above and below the carrier wave as shown in the diagram on the right and is expressed with the ratio of the power of the single sideband phase noise to the carrier wave power within a 1 Hz bandwidth with the offset frequency from the carrier. When a spectrum analyzer is used, the carrier wave power and the sideband noise can be viewed directly on the screen. However, the following points must be noted when using a spectrum analyzer.

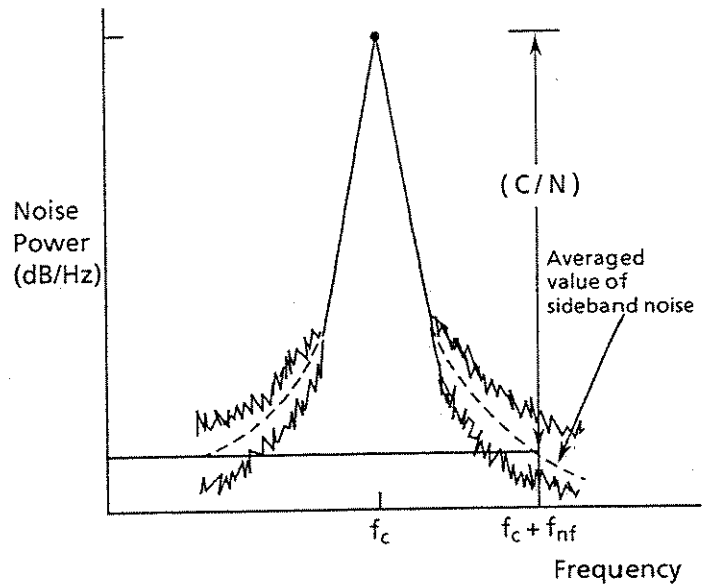

Single Sideband Phase Noise

(1) Averaging noise power

Since a spectrum analyzer has a peak-hold circuit in front of an A/D converter, when noise is measured, the maximum power of the noise over the sampling time is displayed. Generally, noise is evaluated as the average value of the power against time. Consequently, it is necessary to set DET MODE to SAMPLE and to narrow the VBW in order to average the noise power.

(2) Conversion for noise bandwidth

Since the measured noise power depends on the noise bandwidth, correction in accordance with the noise bandwidth is required.

(3) Correction of average noise value

In a spectrum analyzer, since the signal is logarithmically-converted and envelope-detected, the average value of the noise appears to be lower than the actual rms noise value, so this part must also be corrected.

In the MS2602A, this correction is performed automatically by using the NOISE MEASURE function and the single sideband noise can be measured easily.

(4) Measurement procedure

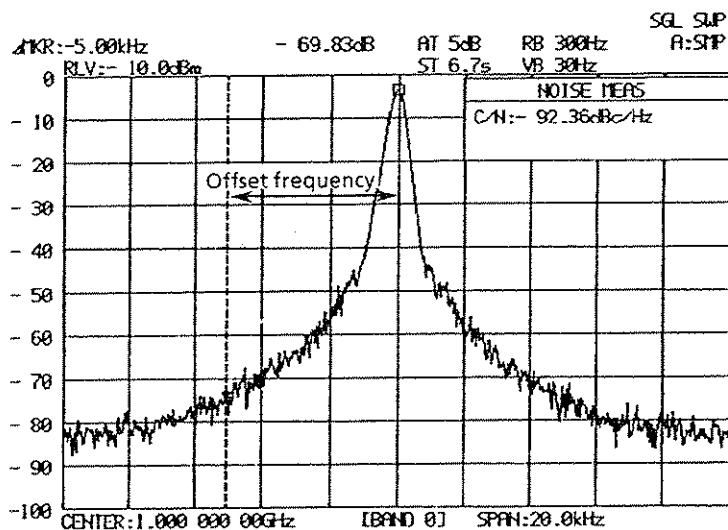

Example of Side Band Noise Measurement

Step	Procedure
1	Set the center frequency to the carrier frequency of the signal to be measured.
2	Set the span frequency to approximately three times the sideband noise offset frequency.
3	Press the Peak [→ CF] and Peak [→ Ref] keys in this order for tuning so that the carrier spectrum is positioned in the center of the screen.
4	Set the video bandwidth (VBW) to 10 Hz or 30 Hz.
5	Set the zone marker to the spot marker.
6	Press the [Peak Search] key to overlap the marker to the peak point of the signal.
7	Press the [Measure], [F2: NOISE MEAS], and [F2: NOISE ABSOLUTE / C/N RATIO] keys in that order to select C/N RATIO.
8	Press the [F1: ON] key to start the C/N measurement. This key operation automatically puts the marker function in the delta mode.
9	Move the marker so that the delta marker frequency display becomes the sideband noise offset frequency.
10	Read the noise level value in the measure window in the upper right-hand corner of the graticule.

13.8 Occupied Frequency Bandwidth Measurement

The MS2602A Occupied frequency Bandwidth Measurement function (OBW MEAS) provides two ways to measure the occupied frequency bandwidth.

- (1) X dB DOWN method The frequency bandwidth between the points at which the level is lower by X dB from the peak point of the signal.

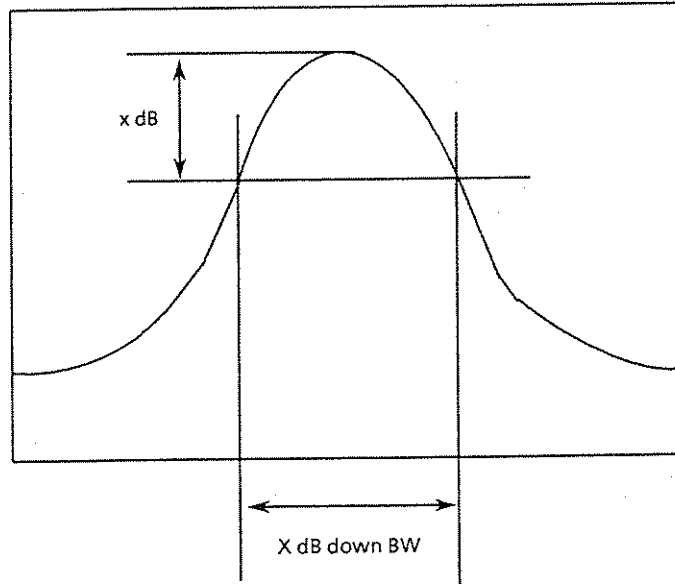

- (2) N % of POWER method The frequency bandwidth occupied by N% of the power, assuming that the total power of the spectrum displayed on the screen is 100 %.

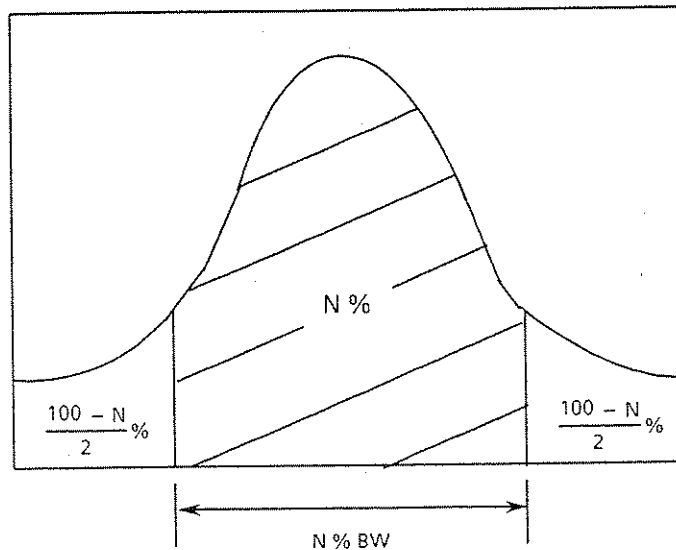

13.8.1 Occupied frequency bandwidth measurement by the X dB DOWN method

To measure the occupied frequency bandwidth by the X dB DOWN method, perform the following key operations.

- ① Set the center frequency to the signal frequency, then set the frequency span so that the waveform lower by X dB from the peak level appears on the screen.
- ② Perform the following key operations to set the "X" value of X dB.
(If step ② is performed before making a measurement, this setting is allowed at any time.)

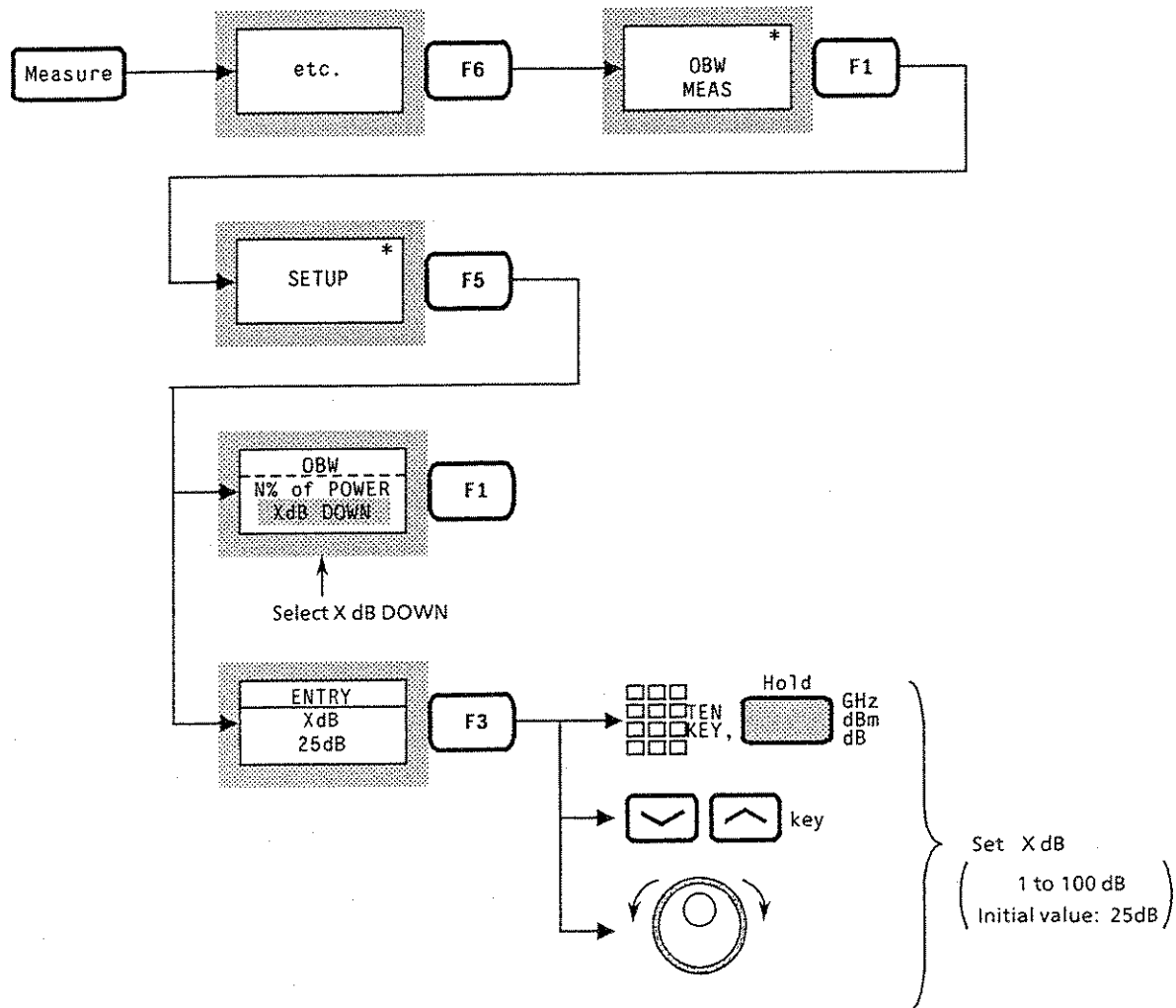

- ③ Perform the key operations shown below to measure the occupied frequency bandwidth. The measured results are displayed in the measure window in the upper right-hand corner of the graticule.

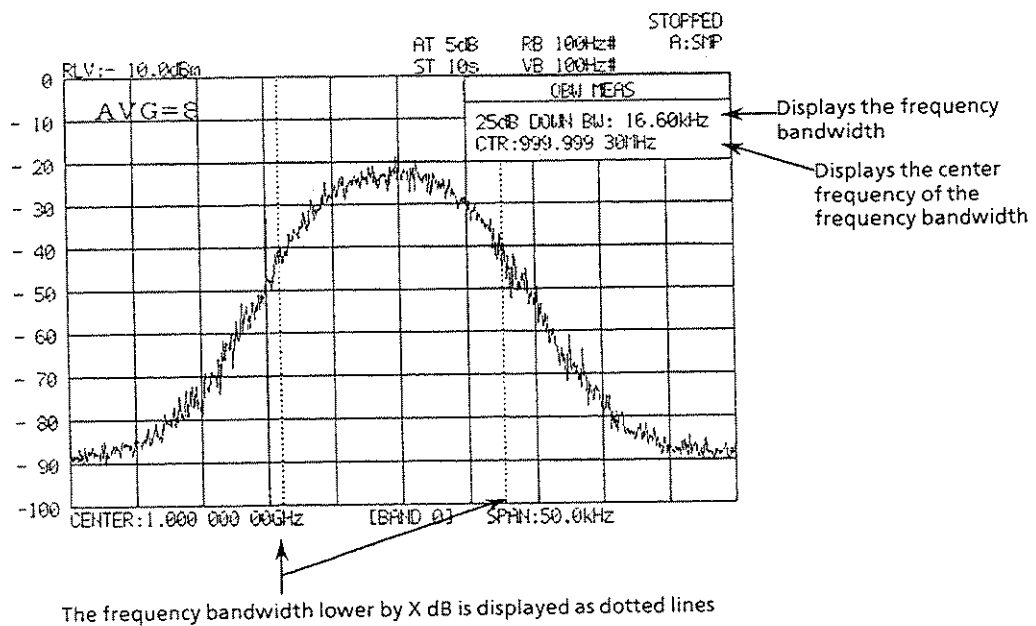
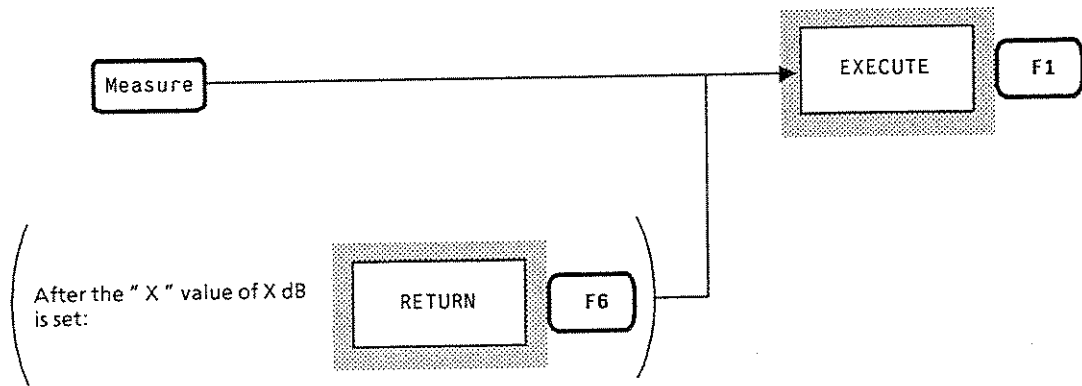

- Notes:**
- The measurement is executed only when the [F1 : EXECUTE] key is pressed in step ③. The measurement is not executed at each sweep.
 - When video averaging is required prior to occupied frequency bandwidth measurement, first perform video averaging to average the displayed waveform, then execute step 3 in the above procedure.
 - The marker is set to OFF when the occupied frequency bandwidth is executed.
 - Select one of the following detection modes, depending on the transmitter modulation system. For details, follow the measurement method of the communication system.
Analog system.....SAMPLE
Digital system.....POS PEAK

13.8.2 Occupied frequency bandwidth measurement by the N% of POWER method

To measure the occupied frequency bandwidth by the N% of POWER method, perform the following key operations.

- ① Set the center frequency to the signal frequency, then set the frequency span to approximately three times the occupied frequency bandwidth.
- ② Perform the following key operations to set the "N" value of N%.
(If step ② is performed before making a measurement, this setting is allowed at any time.)

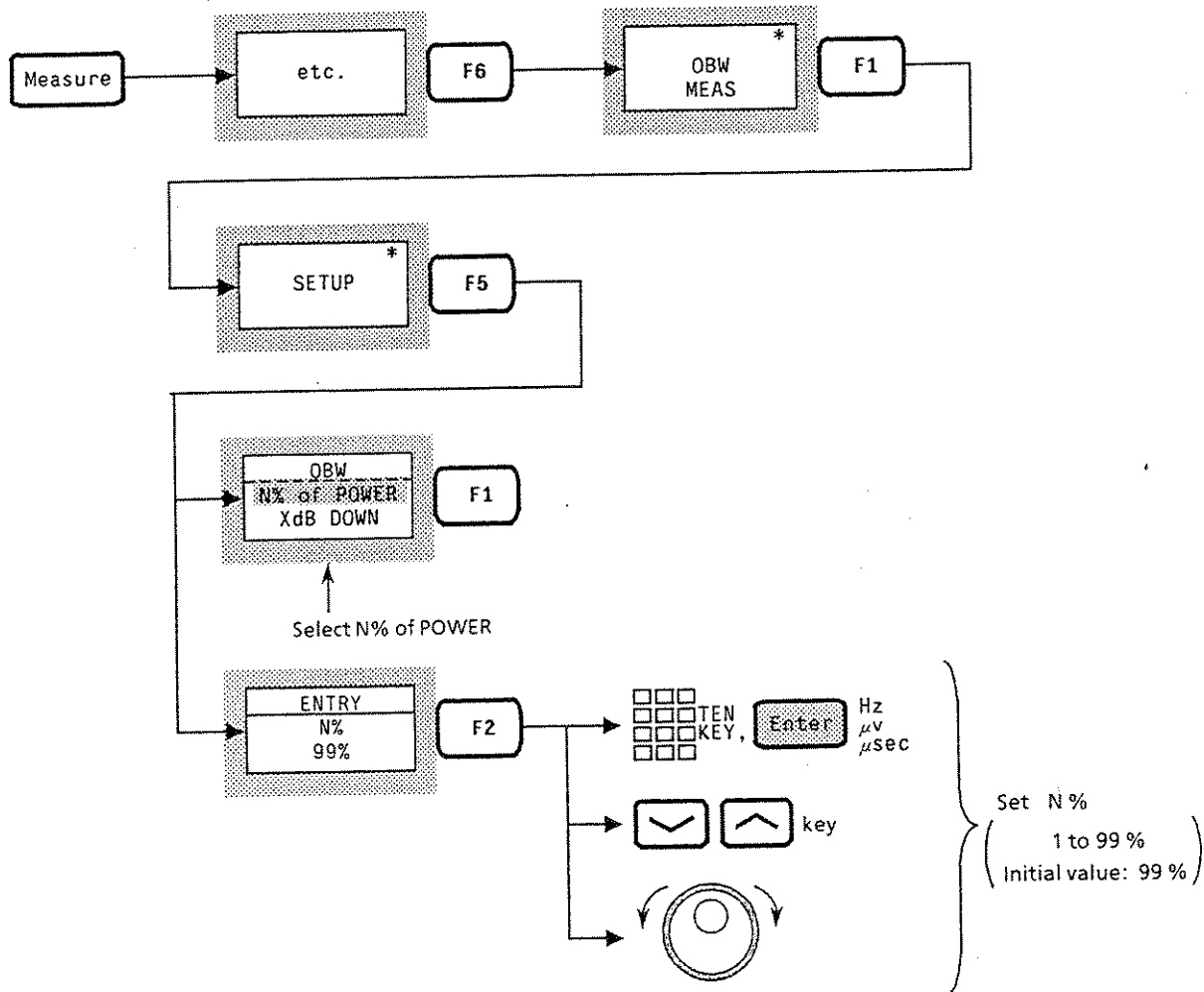

③ Perform the following key operations to measure the occupied frequency bandwidth, and the measured results are displayed in the measure window at the upper right-hand corner on the graticule.

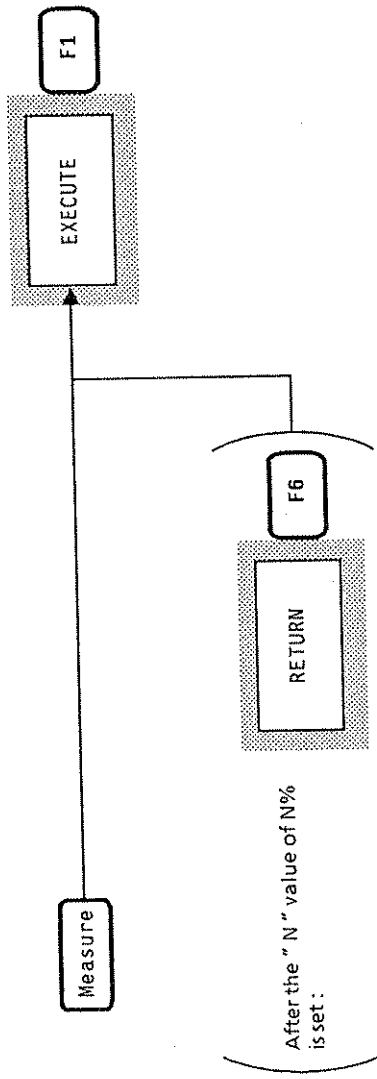

After the "N" value of N% is set:

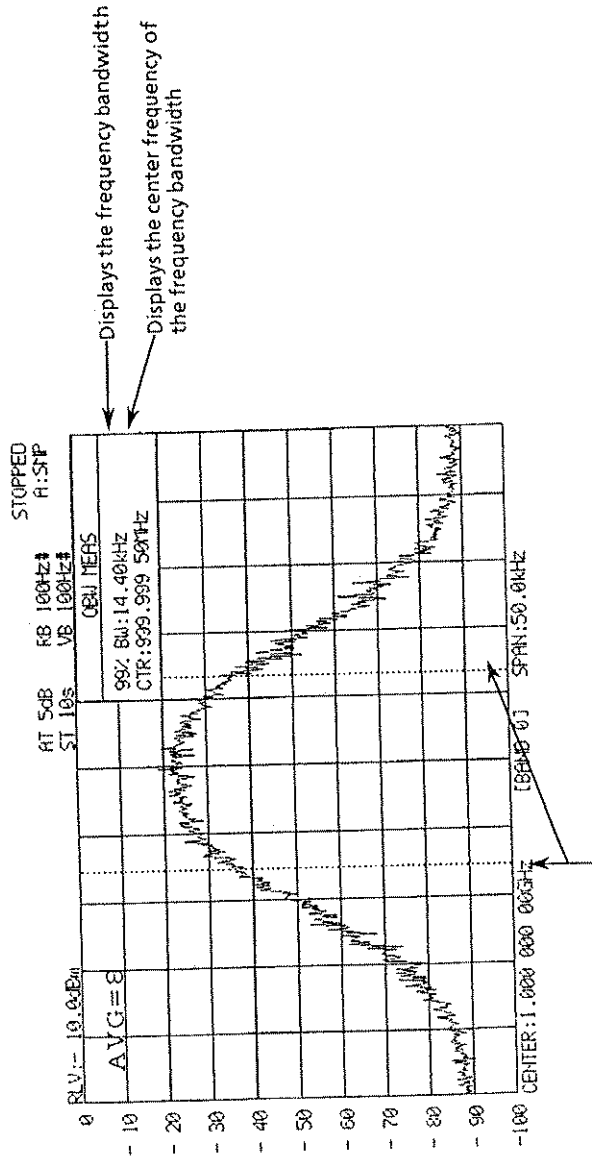

The frequency bandwidth occupied by N % is displayed as dotted lines

- Notes:
- The measurement is executed only when the [F1: EXECUTE] key is pressed in step ③.
 - The measurement is not executed at each sweep.
 - When using averaging is required prior to the occupied frequency bandwidth, first perform the

- ② On the basis of the waveform measured in trace A, calculate the leakage power for the set channel width over all the frequency points, then display the result on trace B in graph format.

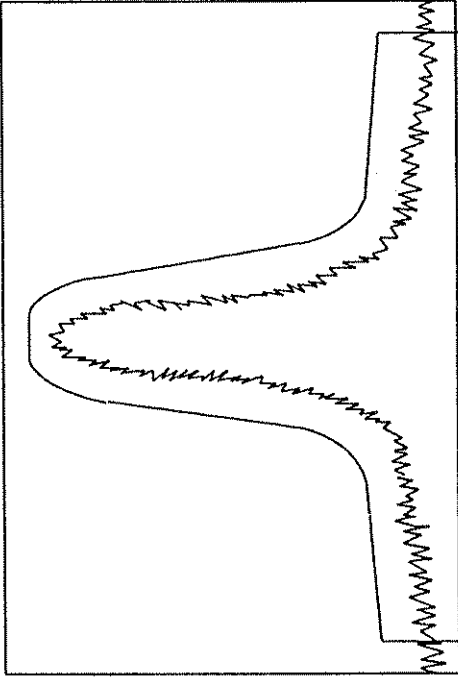

This can be obtained within the upper (or

2602A can measure

t method)

he spectrum on the reference frequency is

13.9.1 Adjacent channel leakage power measurement in which a channel is specified

Measure the adjacent channel leakage power for a specified channel as follows:

- ① Set the center frequency to the signal frequency. Set the frequency span to a width which covers the adjacent channel to be measured.
- ② Set a resolution bandwidth which is suitably narrow when compared to the channel width. Select SAMPLE or POS PEAK detection mode† according to the requirements of the communication system measurement method for the transmitter to be measured.
- ③ Make the following settings according to the measurement method.

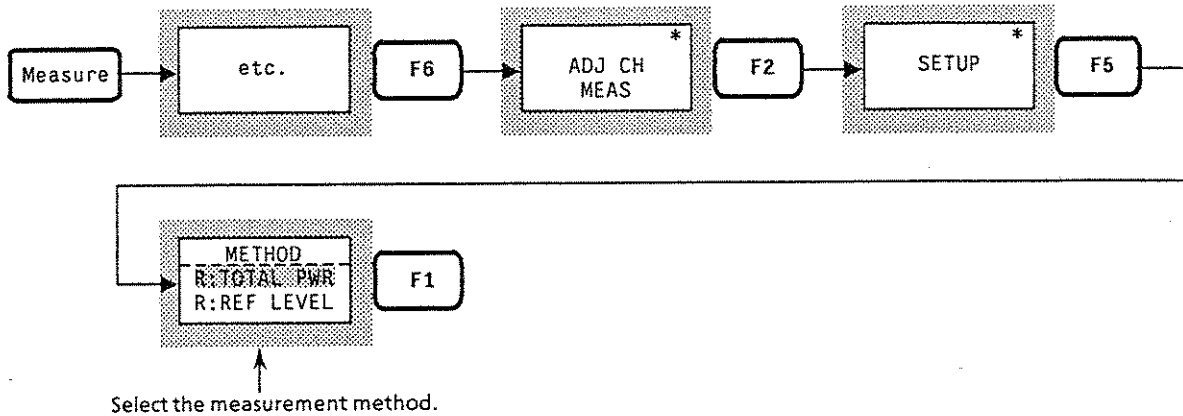

- i) For the R: TOTAL PWR method (measurement relative to the total power of modulated wave)

Set the zone marker center frequency (spot marker frequency) to the signal frequency. Set the reference level so that its signal is hardly distorted. (If the signal total power becomes much greater than the reference level, then intermodulation can be generated in the modulated wave itself. This also allows a high adjacent channel leakage power value.)

- ii) For the R: REF LEVEL method (measurement relative to the peak level when non-modulated)

Execute PEAK → CF, PEAK → REF with the signal non-modulated, then set the signal peak to the reference level at the center frequency. Next, set the signal so that it is modulated.

† In MS2602A detection mode, SAMPLE is usually selected for analog systems; POS PEAK for digital systems.

④ Set the channel separation and channel bandwidth and select the channel to be measured as follows:

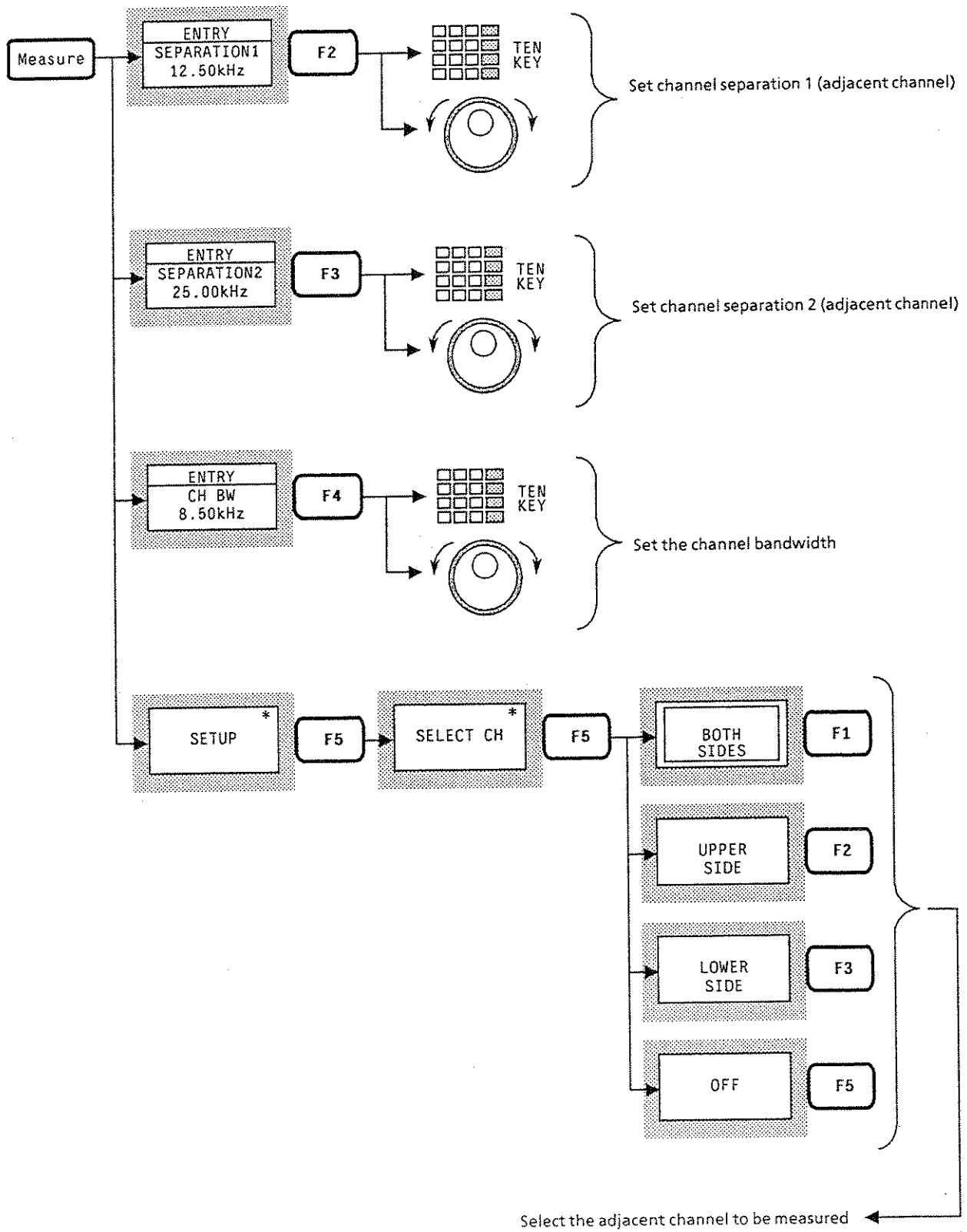

- ⑤ Perform the key operations shown below to measure the adjacent channel leakage power. The measured results are displayed in the measure window in the upper right-hand corner of the graticule.

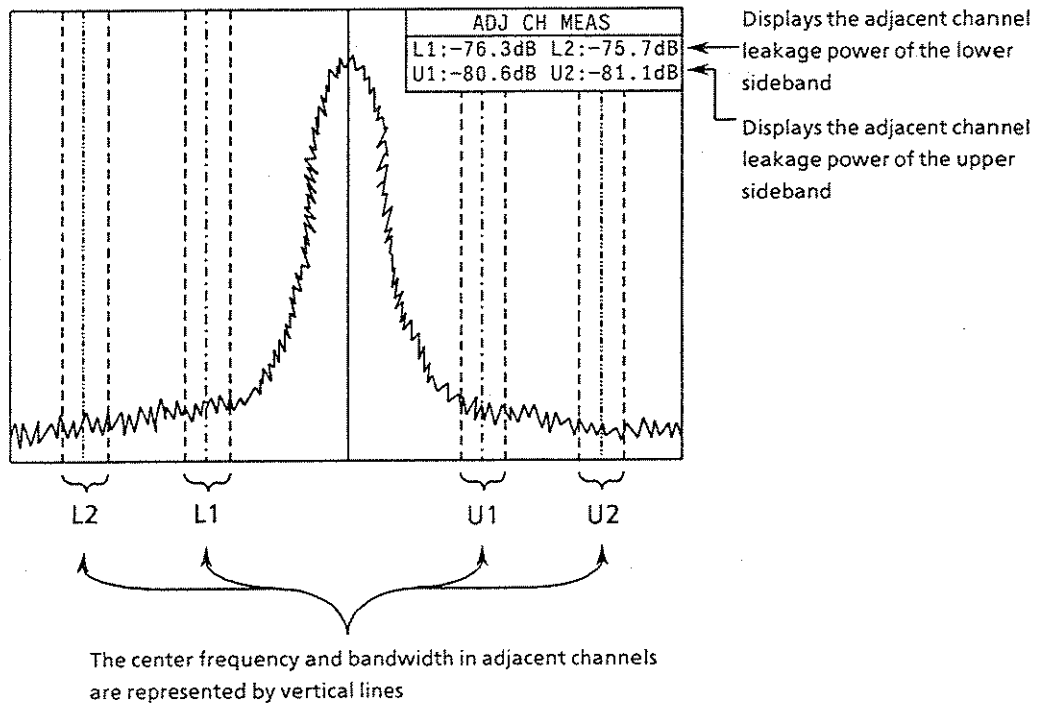
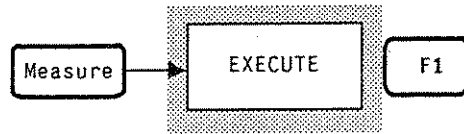

The vertical lines shown by each adjacent channel can be turned ON/OFF by the following key operations.

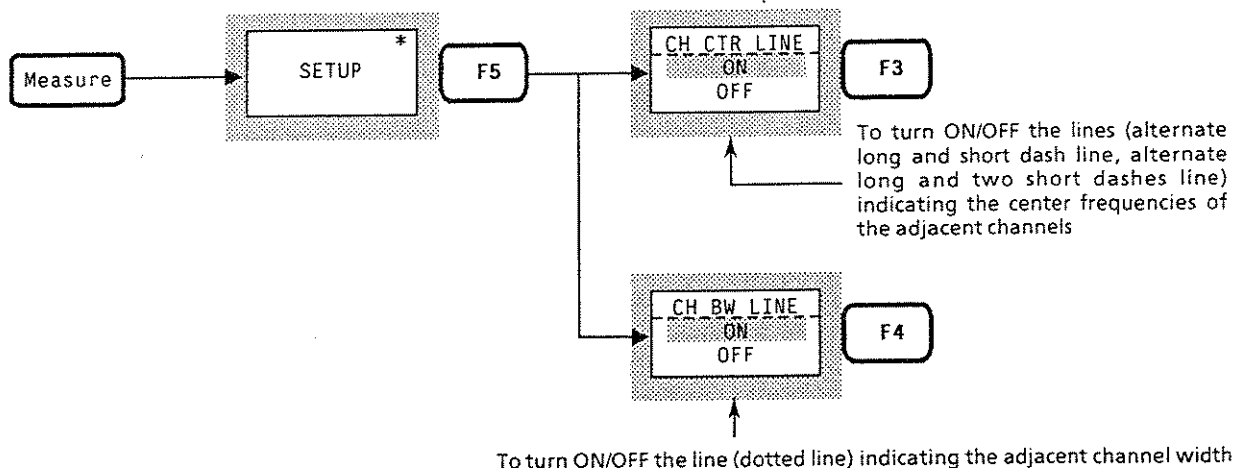

- Notes:**
- The measurement is executed only when the the [F1: EXECUTE] key is pressed in step ⑤. The measurement is not executed at each sweep.
 - When video averaging is required prior to the occupied frequency bandwidth measurement, first perform the video averaging to average the displayed waveform, then execute step ⑤ in the above procedure.
 - The adjacent channel leakage power measured for the waveform displayed on trace A. This should be measured when trace A or trace A/B is selected.

13.9.2 Adjacent channel leakage power measurement in which a graph is displayed

Steps ① through ④ in the procedure for the adjacent channel leakage power measurement in which a graph is displayed are the same as steps ① through ④ in the procedure for the adjacent channel leakage power measurement in which a channel is specified.

Perform the following key operations from step ⑤. The display is switched to trace A/B, and the graph is displayed on trace B.

- ⑤ Select ON for graph display. (ON has been selected at initial setting)

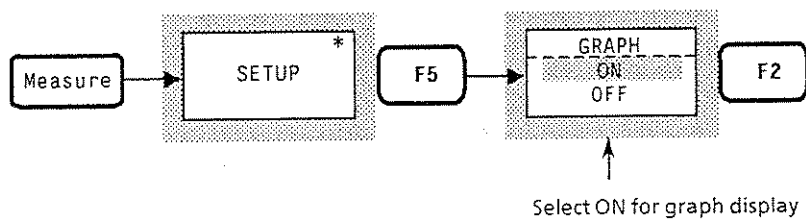

- ⑥ Perform the key operations shown below to measure the adjacent channel leakage power and display it as a graph:

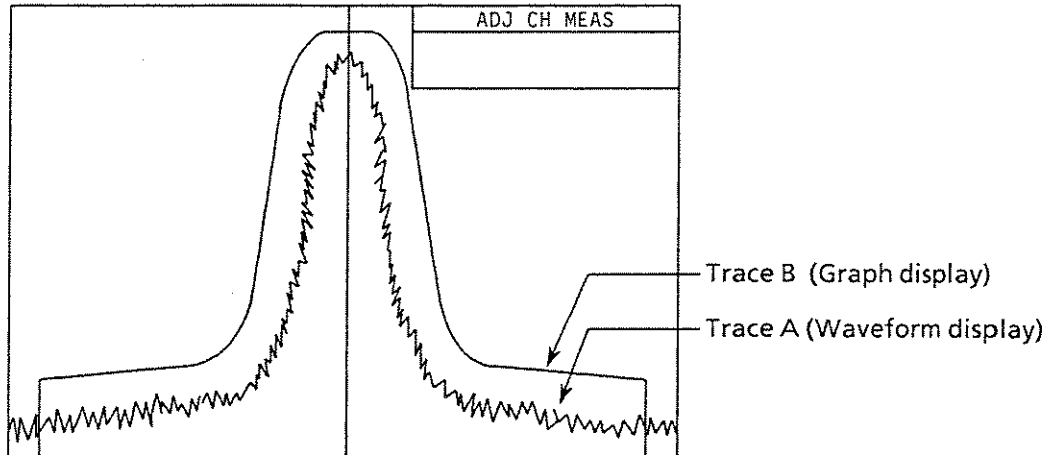
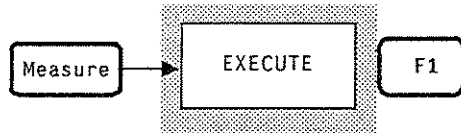

The graph is displayed so that the top horizontal scale line of the screen is 0 dB. The display line is at the top horizontal scale line of the screen as soon as the graph is displayed. At this time the marker level display on trace B is changed to the relative display (REL) when seen from the display line.

- ⑦ Perform the key operations shown below to read the leakage power at any frequency point using a marker:

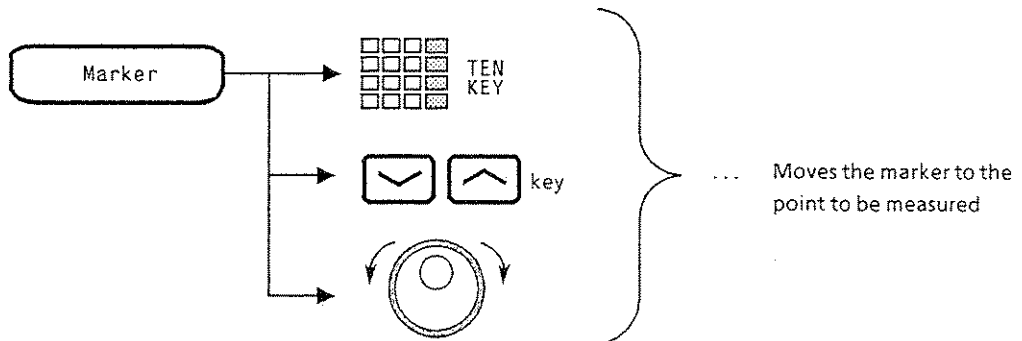
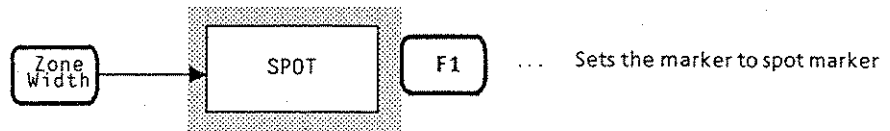
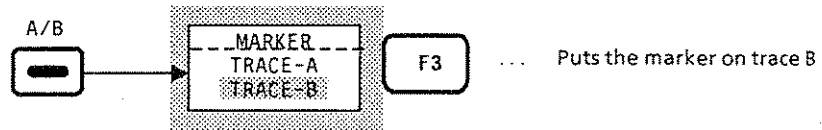

Since the marker on trace B is changed to the display relative to the top horizontal scale line of the screen when the graph display is executed, the marker reading becomes the measured value of the adjacent channel leakage power.

To clear the graph display, press the A key to turn trace B OFF.
For graph display alone, press the B key to turn trace A OFF.

- Notes:**
- The graph is drawn for display only when the [F1: EXECUTE] key is pressed in step ⑥. The graph is not drawn at each sweep.
 - Since the trace B is rewritten to graph when the graph display is executed for the adjacent channel leakage power measurement, check beforehand that an important wave trace is not stored in trace B.
 - When executing the adjacent channel leakage power measurement again by R: TOTAL PWR after moving the marker in step ⑦, always return the marker to the original execution position. Otherwise, the measurement will not be correct because the frequency reference point will have shifted.

- ③ Decide whether an input signal exists within the template. The go / no-go results are displayed in the measure window in the upper right-hand corner of the graticule.

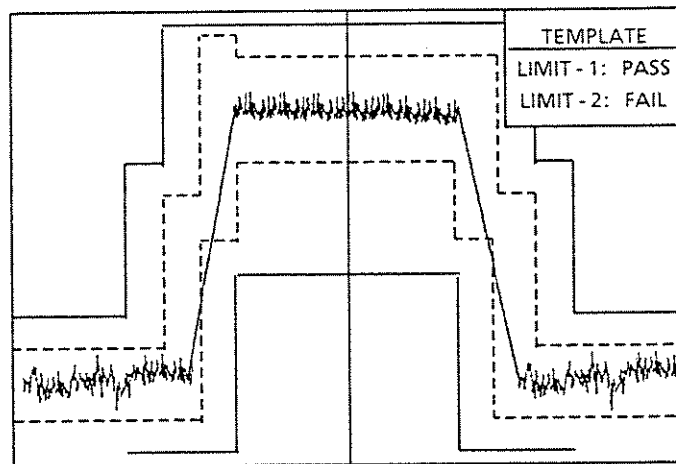
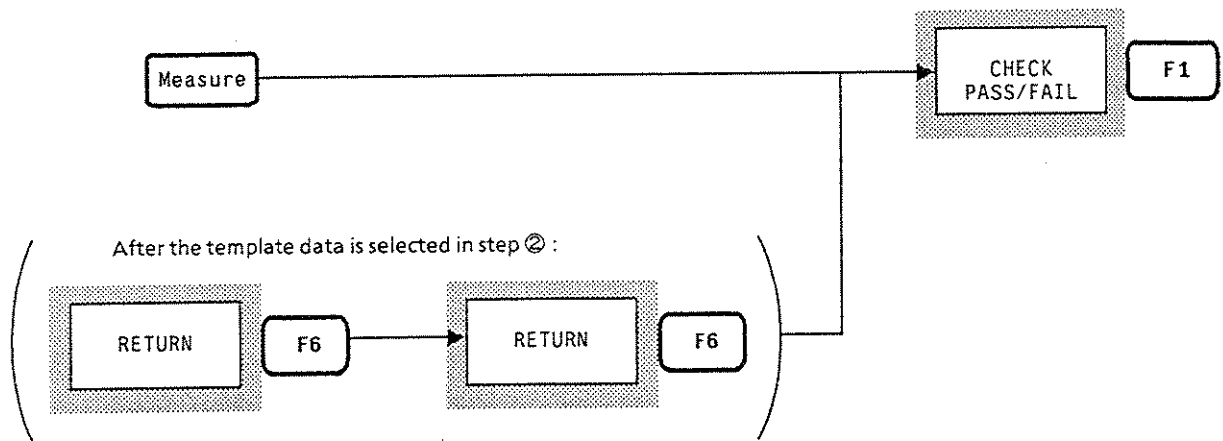

Note: The measurement is executed only when the [F1: CHECK PASS / FAIL] key is pressed in step ③. The measurement is not executed at each sweep.

In the following cases, the template decision cannot be executed.

- When the display mode is frequency domain
- When the FM / TRIG monitor is turned on in the time domain display
- When template data does not exist or is turned off
- When the scale is set to linear scale

13.10.3 Creating template data

Template data comprises two or more limit lines where all the point data entered as X (TIME) and Y (LEVEL) are connected with a straight line.

Set the following items before entering the point data.

- ① **Select the template data to be created (TEMP - 1 to 5)**
The MS2602A can store up to five pairs of template data in internal memory. At step ① , select one of the five pairs of template data.
- ② **Select the limit line (UPPER LINE-1 / 2, LOWER LINE-1 / 2)**
The pair of template data selected in step ① allows four limit lines to be created. In step ②, select the limit line to be created.
- ③ **Select the level display of point data (ABSOLUTE / RELATIVE)**

The level display for point data can be selected by either of the following methods.

- **ABSOLUTE** Displays the level as an absolute value (a value that depends on the scale unit when the data is entered: dBm, dB μ V, dBmV, dB μ V(emf))
- **RELATIVE** Displays the value relative to the reference level of 0 dB or the display line level of 0 dB when the display line is ON.

To select ①, ②, and ③ perform the following key operations. First select ①, then ② and ③.

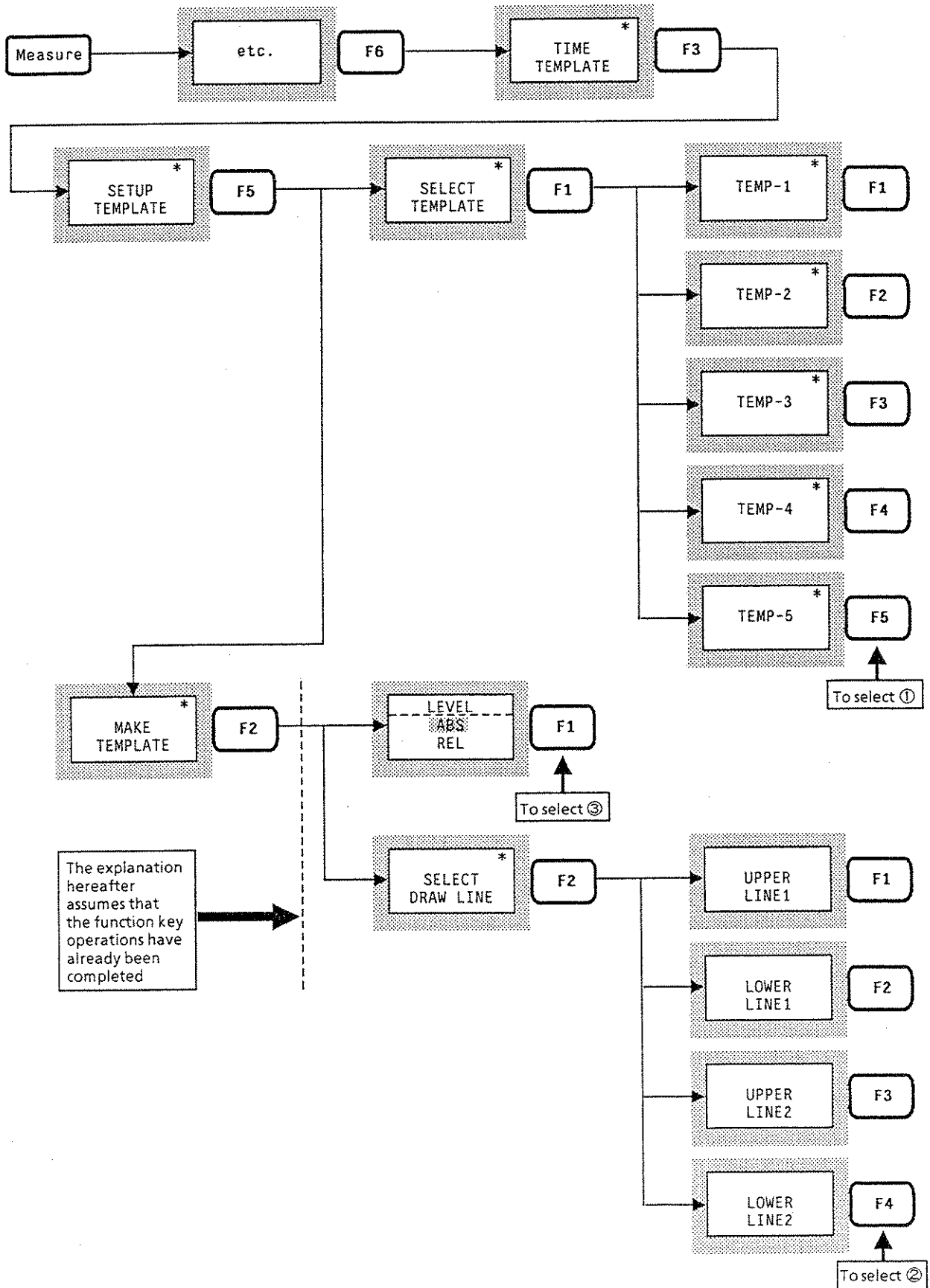

After making the above settings, perform the following key operations. Since the point entry field is displayed at the bottom of the screen, enter the point data in the order of X (TIME) and Y (LEVEL).

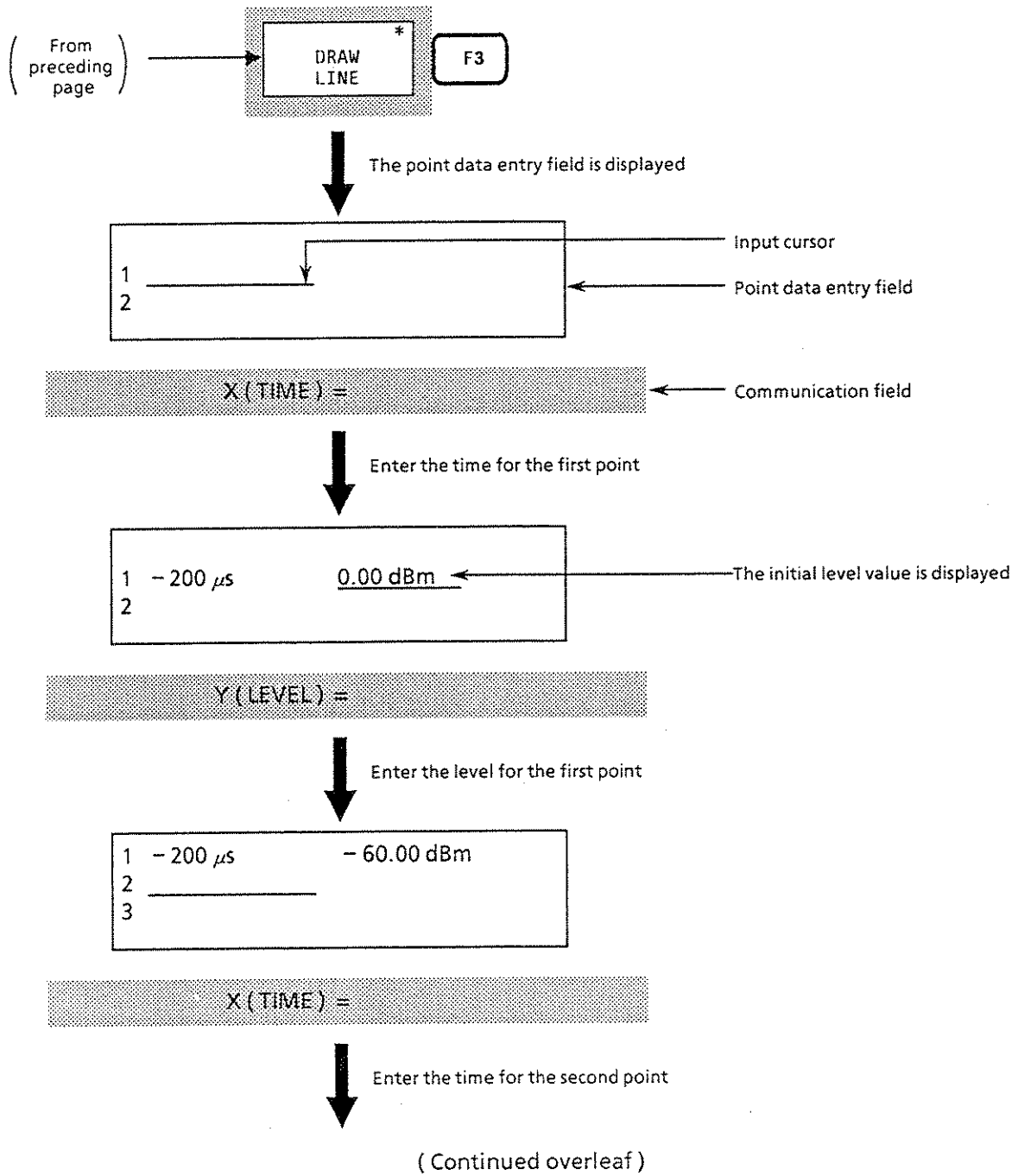

From preceding page

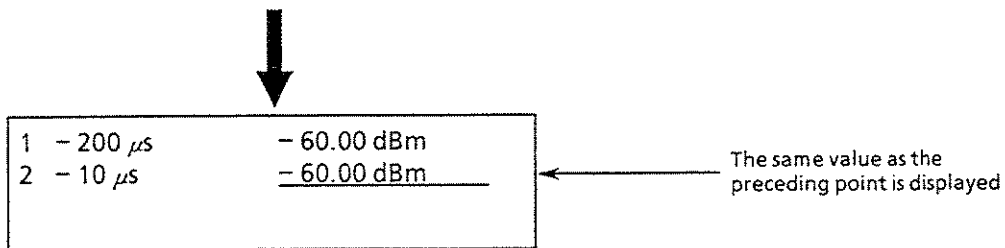

Y (LEVEL) =

Enter the level for the second point

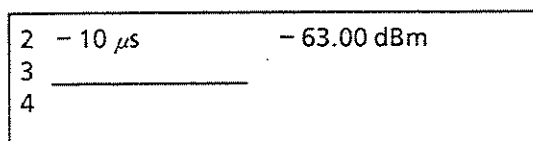

X (TIME) =

⋮

Up to 32 points can be entered

If the entry operation is completed, press the [F6: RETURN] key to return to the Measure menu from the template management menu.

The point data is stored in internal memory after entering each point. This enables data entry to be continued by the above operations, even if the point data entry field is cleared by executing other function during data entry. In this case, the point data entry field can be scrolled with the [∇] [\wedge] key or the rotary knob.

The point data input settings are displayed as a graph or list in the top half of the screen.

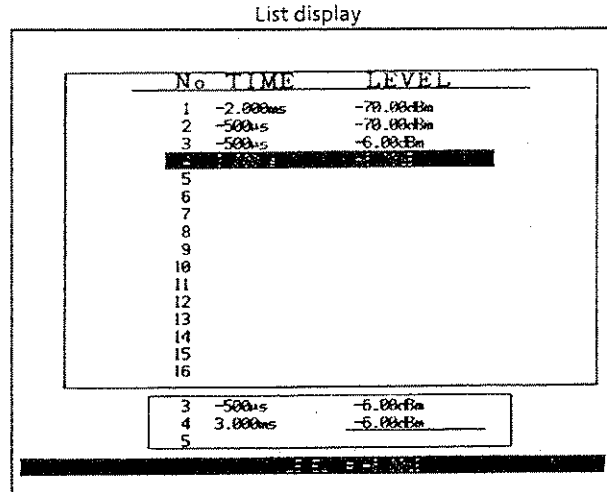
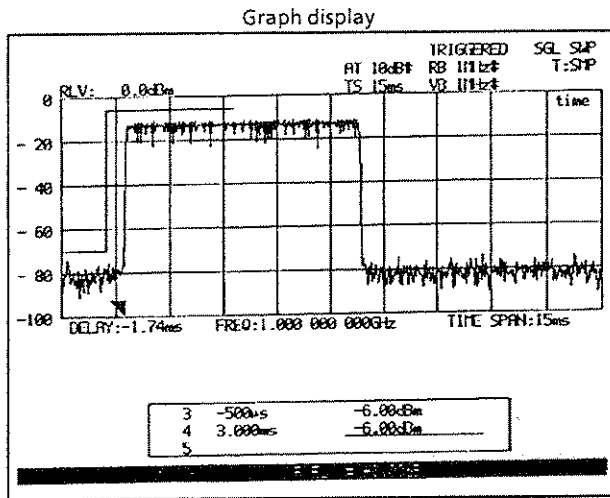

To switch the display format, perform the following key operations.

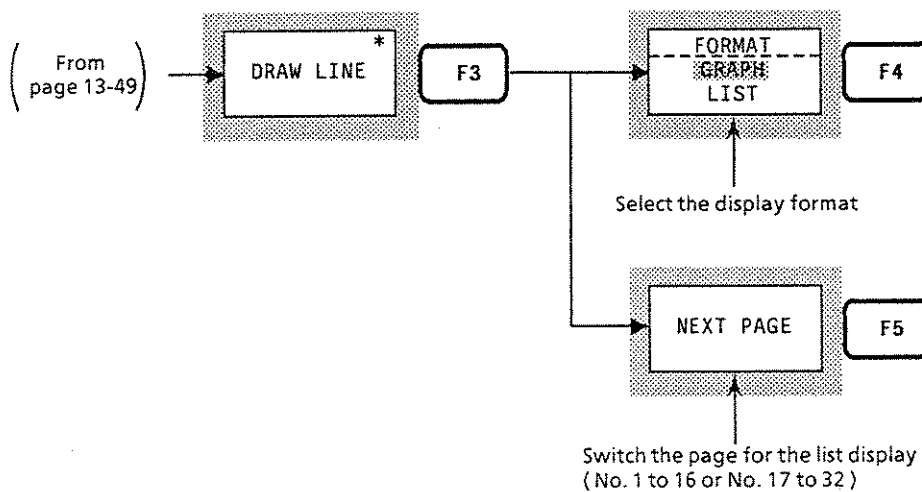

The display format can also be switched even while point data is being entered.

- Notes:**
- *The X (TIME) of the point data can be entered only in ascending order. To add point data, follow the paragraph on " changing template data " described later.*
 - *The X (TIME) of the point data is 0 sec at the trigger point (trigger point indicator marked with ▼).*
 - *The reference level units at that time are used as point data units Y (LEVEL). However, when the reference level units are V system or W system, dBm is used.*
 - *When the point data Y (LEVEL) is set in the ABSOLUTE display and then switched to the RELATIVE display, the Y (LEVEL) value converted into dBm units is also used for the dB units. When the data set in the RELATIVE display is switched to the ABSOLUTE display, the value in dB units is converted to the unit of the reference level as a dBm unit.*
 - *Up to 32 data points per one template data can be set.*
 - *The TEMP-1 to TEMP-5 soft keys allow each menu label to have up to 24 characters. The labels can be entered via GPIB only. For further details, refer to the GPIB remote control part of the separate operation manual.*

13.10.4 Changing template data

This paragraph explains how to change the template data being created or already created.

① To change the value of a point data X (TIME) or Y (LEVEL)

Select REPLACE for the INPUT MODE; use the [√] [^] keys or rotary knob to move the cursor to the point to be changed, then enter the data again using the TEN keys and unit key.

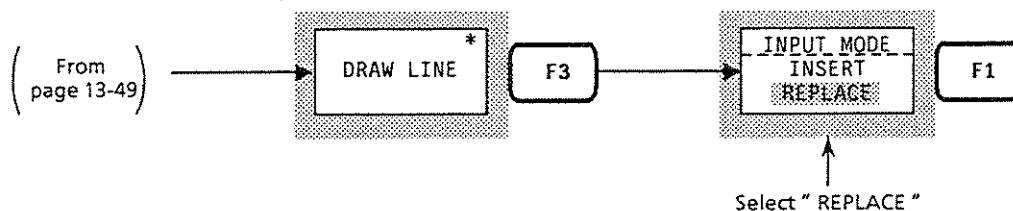

② To insert a point data

Select INSERT for the INPUT MODE; use the [√] [^] keys or rotary knob to move the cursor to the point next to the point to be changed (for example, move the cursor to No. 5 if point data is to be added between points No. 4 and No. 5), then enter the X (TIME) and Y (LEVEL) values using the TEN keys and unit key.

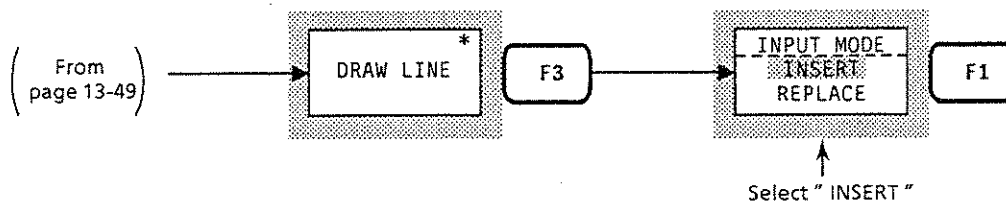

③ To delete only part of the point data

Move the input cursor to the point to be deleted (either X (TIME) or Y (LEVEL)), then press the [F2] (DELETE) key.

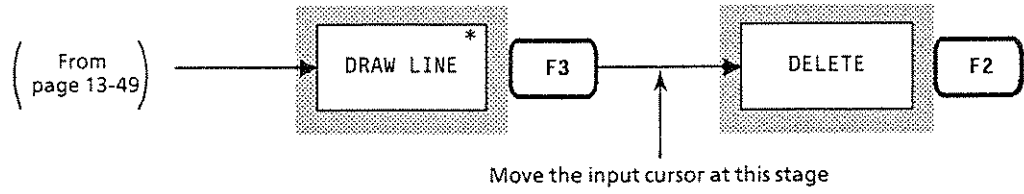

④ To delete all the point data

Perform the following key operations.

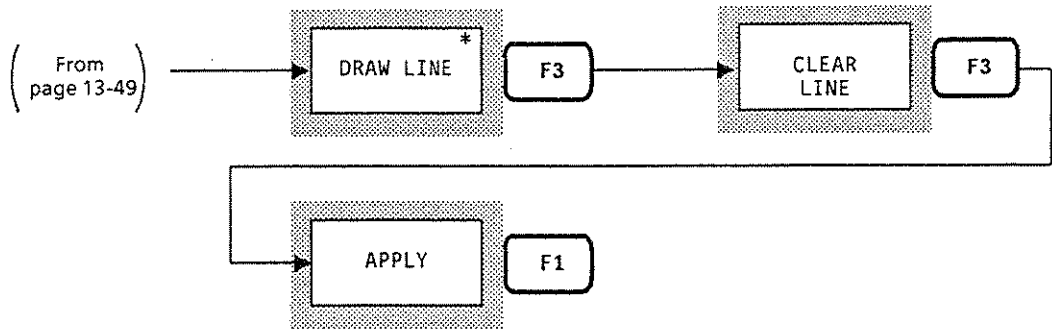

13.10.5 Moving the template

This paragraph explains how to move a template along the time and level axes while creating the template, or while using an existing template. Perform the key operations shown below to move the template.

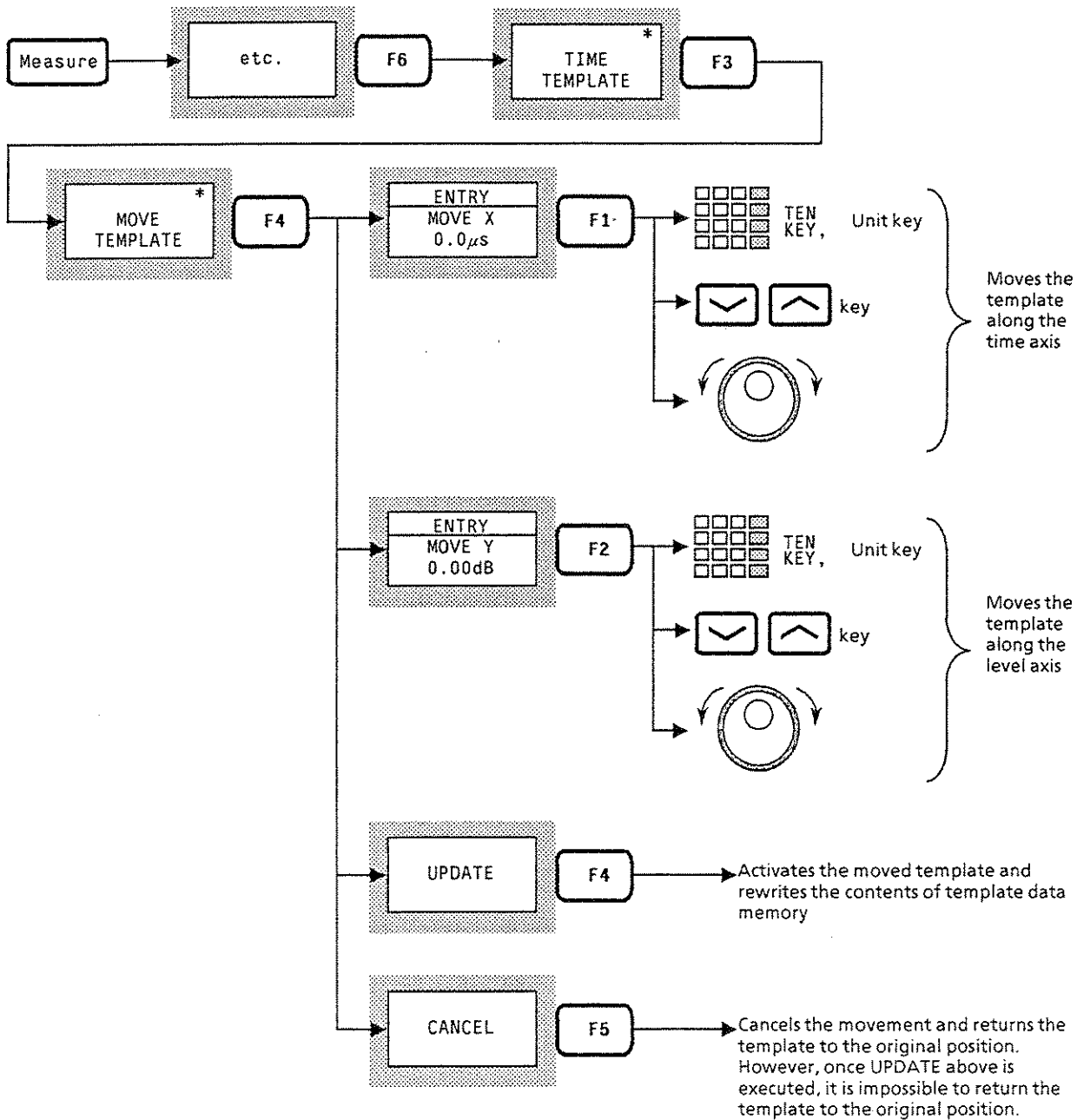

The template movement is so executed as to move all four limit lines (UPPER LINE-1/2, LOWER LINE-1/2) simultaneously as a pair of template data items. It is impossible to move limit lines independently.

13.11 Burst Signal Measurement (Average Power Measurement)

When a burst signal is displayed in time domain mode, the MS2602A measures and displays the average power within the specified time.

The start point and stop point of the MEASURE cursor is set as the horizontal coordinate (0 to 500) of the screen scale to specify the measuring time.

The following shows how to set the MEASURE cursor and execute the measurement.

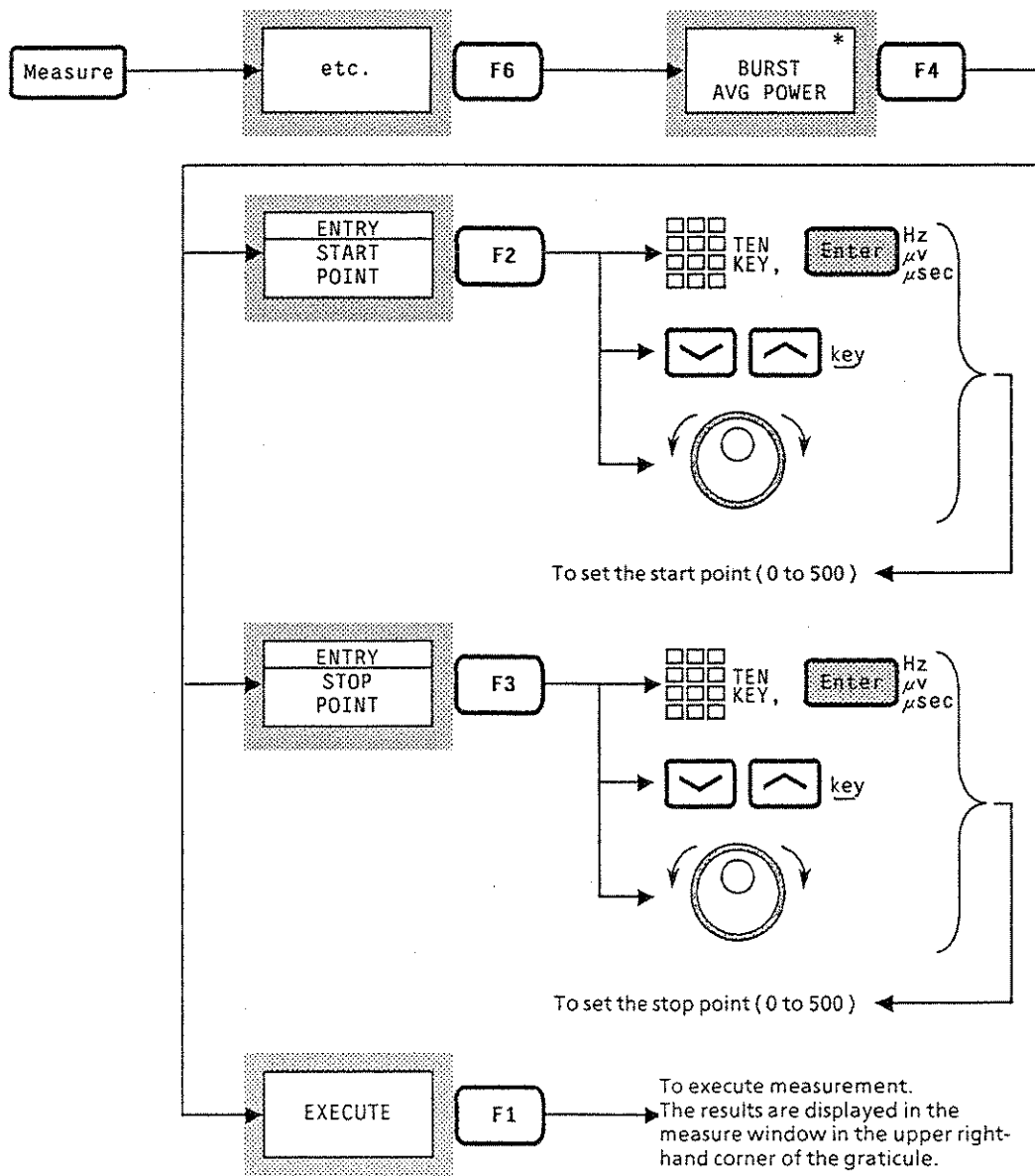

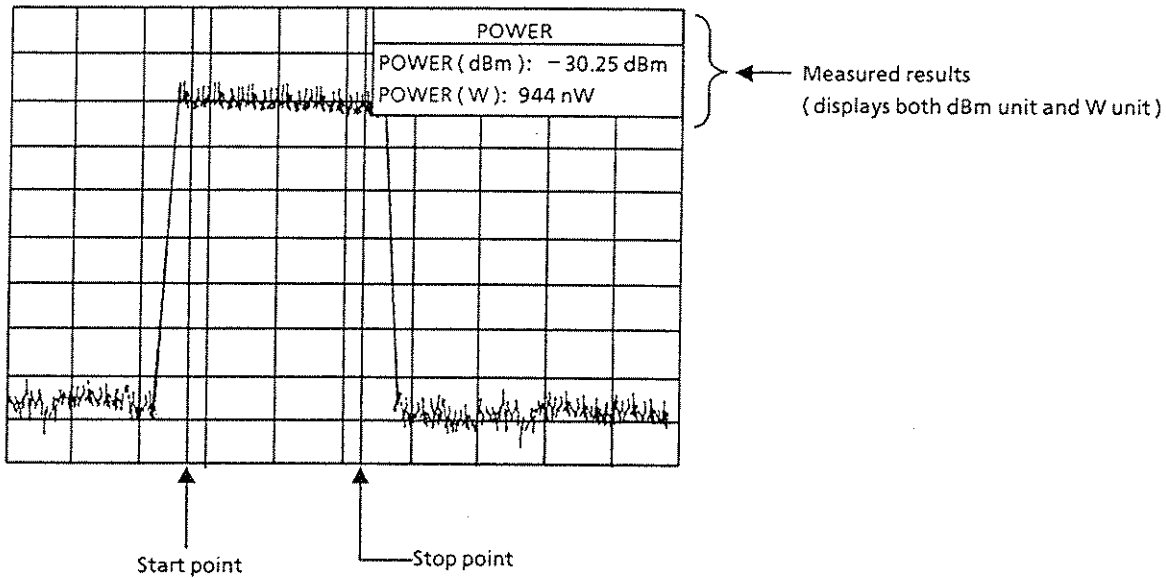

- Notes:**
- The measurement is executed only when the [F1: EXECUTE] key is pressed.
The measurement is not executed at each sweep.
 - Since the MEASURE cursor is set in the horizontal coordinate scale, the cursor position does not move even if the delay time is changed to move the waveform.
 - In the following cases, the measurement cannot be executed.
 - When the display mode is frequency domain
 - When the FM / TRIG monitor is turned on in the time domain display
 - When the scale is set to the linear scale
 - The average power should be measured in the SAMPLE detection mode.
(SAMPLE is selected automatically when the time span is set to less than 50 ms.)

13.12 Setting the Measure Window Display Position

The measurement function, including the frequency and noise level measurements which are activated by the Measure key, allows the measured results to be displayed within the scale. The window (measure window) which displays the measured results is initially in the upper right-hand corner of the scale. The window can be moved if it cannot be seen clearly when overlapped by a waveform. Perform the key operations shown below to move the measure window.

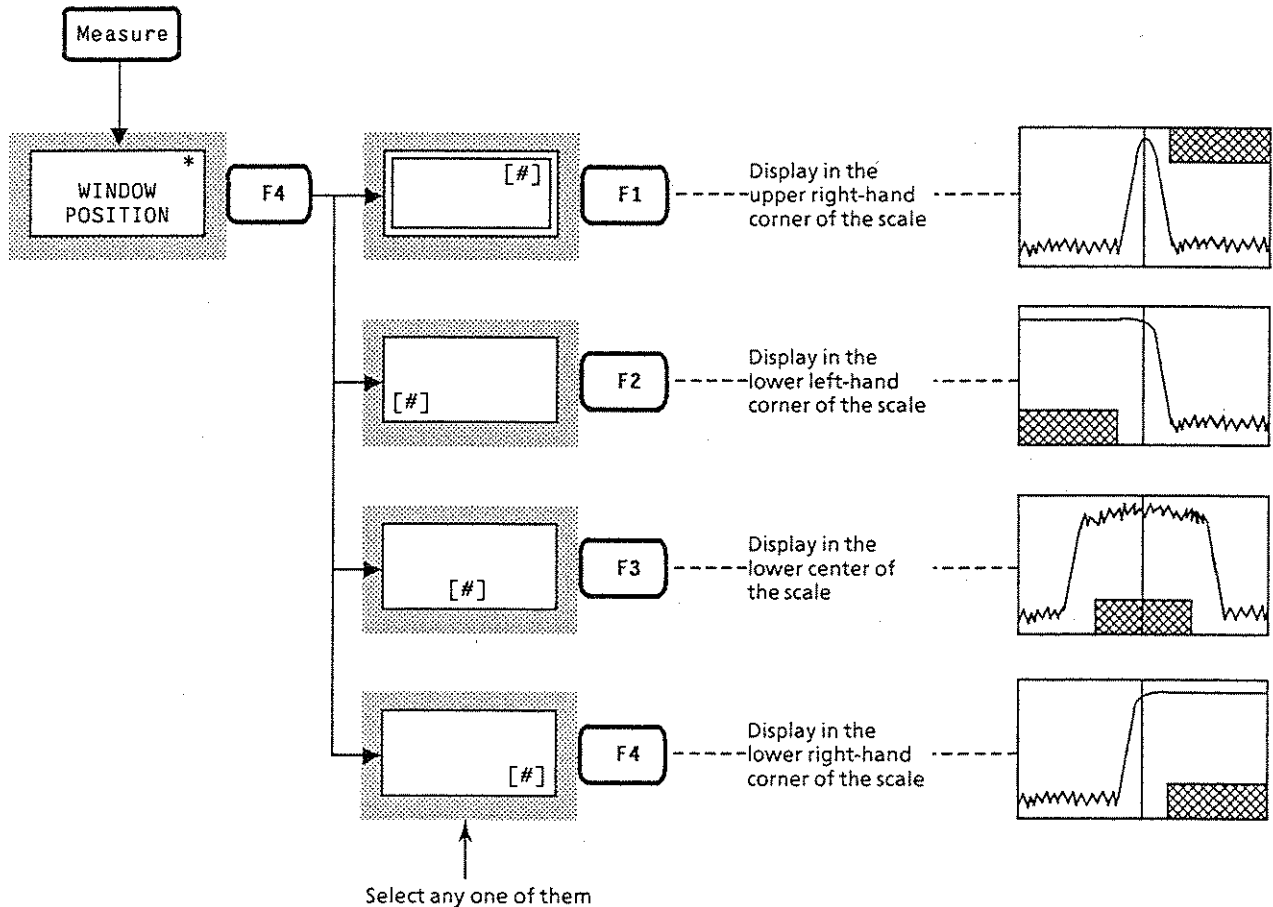

Note: When screen data is plotted, the measure window is always in the upper right-hand corner on the hard copy, regardless of the window location on the CRT screen.

(Blank)

13-60.

SECTION 14 SOFT KEY MENU INDEX

The soft key menu index is useful as a reference for specific functions during operation. The menu title names are listed alphabetically as follows:

Soft Key Menu Index (1 / 4)

Menu title	Page
ADJ CH MEAS	P 14-5
AMPTD (1 / 2)	P 14-6
AMPTD (2 / 2)	P 14-7
ATTEN	P 14-8
BAUD RATE1	P 14-9
BAUD RATE2	P 14-10
CAL	P 14-11
CLEAR LINE	P 14-12
COPY CONT	P 14-13
CORRECTION	P 14-14
CUM / OVER	P 14-15
CUM / OVER	P 14-16
CUM / OVER	P 14-17
DATE / TIME	P 14-18
DET MODE	P 14-19
DET MODE	P 14-20
DET MODE	P 14-21
DIRECTORY	P 14-22
DISPLAY LINE	P 14-23
DISPLAY LINE	P 14-24
DISPLAY LINE	P 14-25
DISPLAY LINE	P 14-26
DRAW LINE	P 14-27
EXPAND MODE	P 14-28
EXT TRIG	P 14-29

Soft Key Menu Index (2 / 4)

Menu title	Page
FINE ADJ	P 14-30
FM	P 14-31
FORMAT	P 14-32
FREQ (1/2)	P 14-33
FREQ (2/2)	P 14-34
FREQ MEAS	P 14-35
GATE	P 14-36
GP-IB	P 14-37
ITEM	P 14-38
LIN SCALE	P 14-39
LOCATION	P 14-40
LOG SCALE	P 14-41
LOG SC UNIT1	P 14-42
LOG SC UNIT2	P 14-43
MAKE TEMP	P 14-44
MANUAL SET	P 14-45
MARKER	P 14-46
MAX / MIN / AVG	P 14-47
MAX / MIN / AVG	P 14-48
MAX / MIN / AVG	P 14-49
MEASURE (1/2)	P 14-50
MEASURE (2/2)	P 14-51
MKR →	P 14-52
MONITOR	P 14-53
MOVE TEMP	P 14-54
MULTI MKR	P 14-55
NOISE MEAS	P 14-56
OBW MEAS	P 14-57
PAPER SIZE	P 14-58
PARITY	P 14-59
PEAK SEARCH	P 14-60

Soft Key Menu Index (3 / 4)

Menu title	Page
PMC	P 14-61
PMC	P 14-62
PMC	P 14-63
POWER	P 14-64
PRESEL TUNE	P 14-65
PRMTR	P 14-66
PTA (1 / 4)	P 14-67
PTA (2 / 4)	P 14-68
PTA (3 / 4)	P 14-69
PTA (4 / 4)	P 14-70
RBW	P 14-71
RECALL	P 14-72
REF LVL STEP	P 14-73
RESOLUTION	P 14-74
RLV OFFSET	P 14-75
RS232C	P 14-76
SAVE	P 14-77
SCROLL STEP	P 14-78
SELECT CH	P 14-79
SELECT CORR	P 14-80
SELECT LINE	P 14-81
SELECT MEDIA	P 14-82
SELECT MEDIA	P 14-83
SELECT MEDIA	P 14-84
SELECT TEMP	P 14-85
SELECT TEMP	P 14-86
SETUP	P 14-87
SETUP	P 14-88
SETUP PLTR	P 14-89
SETUP PTR	P 14-90
SETUP TEMP	P 14-91

Soft Key Menu Index (4 / 4)

Menu title	Page
SOUND	P 14-92
SPAN	P 14-93
START / SPAN	P 14-94
STOP BIT	P 14-95
STORAGE / DET	P 14-96
SWP TIME	P 14-97
SWP TIME	P 14-98
SYSTEM	P 14-99
TEMPLATE	P 14-100
TEMP-1	P 14-101
TEMP-2	P 14-102
TEMP-3	P 14-103
TEMP-4	P 14-104
TEMP-5	P 14-105
TIME	P 14-106
TITLE	P 14-107
TRACE-A	P 14-108
TRACE-A / B	P 14-109
TRACE-A / BG	P 14-110
TRACE-A / TIME	P 14-111
TRACE-B	P 14-112
TRACE FILES	P 14-113
TRIG	P 14-114
TRIG SOURCE	P 14-115
TV TRIG	P 14-116
VBW	P 14-117
VBW	P 14-118
WINDOW POSN	P 14-119
ZONE WIDTH	P 14-120

Executes the adjacent channel leakage power measurement
Sets the channel separation 1
Sets the channel separation 2
Sets the channel bandwidth
Displays the menu for setting the adjacent channel leakage power measurement conditions
Returns to the preceding menu. ↶ to MEASURE (2/2)

ADJ CH MEAS

EXECUTE

ENTRY
SEPARATION1
12.50kHz

ENTRY
SEPARATION2
25.00kHz

ENTRY
CH BW
8.50kHz

SETUP *

RETURN

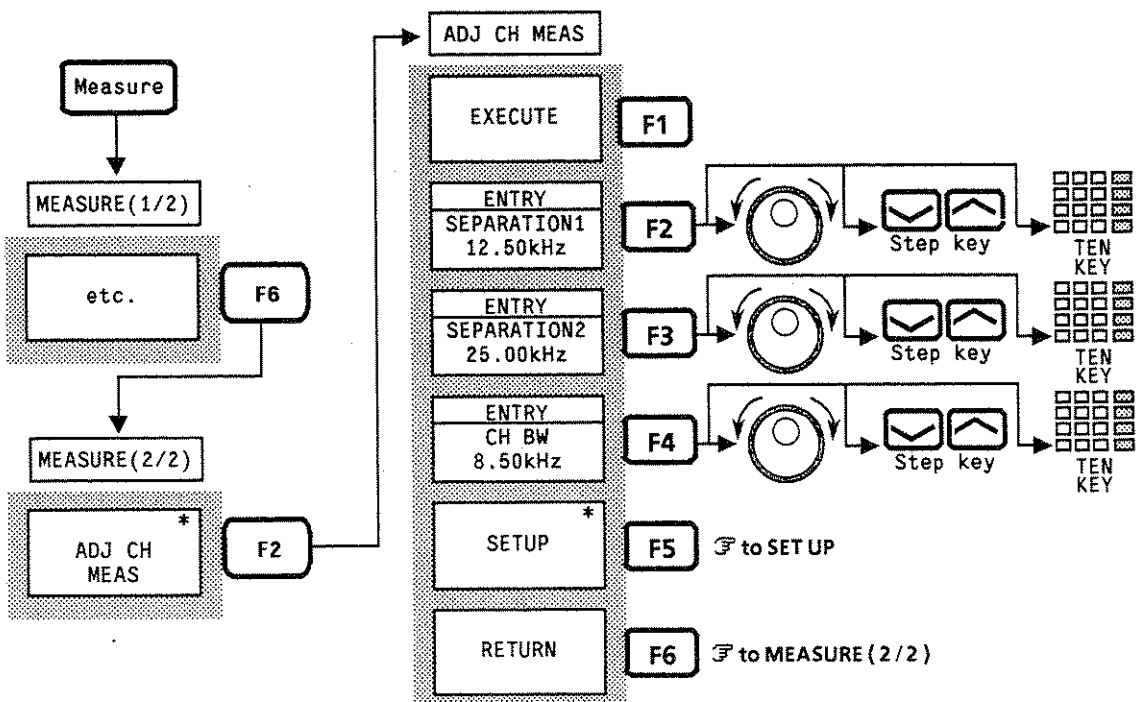

Sets the reference level	AMPTD (1/2)
Displays the menu for selecting the reference level step size to be set with the [V][^] key. ↻ to LOG SC STEP	REF LEVEL
Sets the amplitude scale to log scale mode, then displays the menu for selecting the log scale size. ↻ to LOG SCALE	REF LEVEL * STEP SIZE
Sets the amplitude scale to linear scale mode, then displays the menu for selecting the linear scale size. ↻ to LIN SCALE	LOG SCALE *
Displays the menu for selecting the reference level unit. ↻ to LOG SC UNIT	LIN SCALE *
Displays the AMPTD (2 / 2) menu. ↻ to AMPTD (2 / 2)	LOG SCALE * UNIT
	etc.

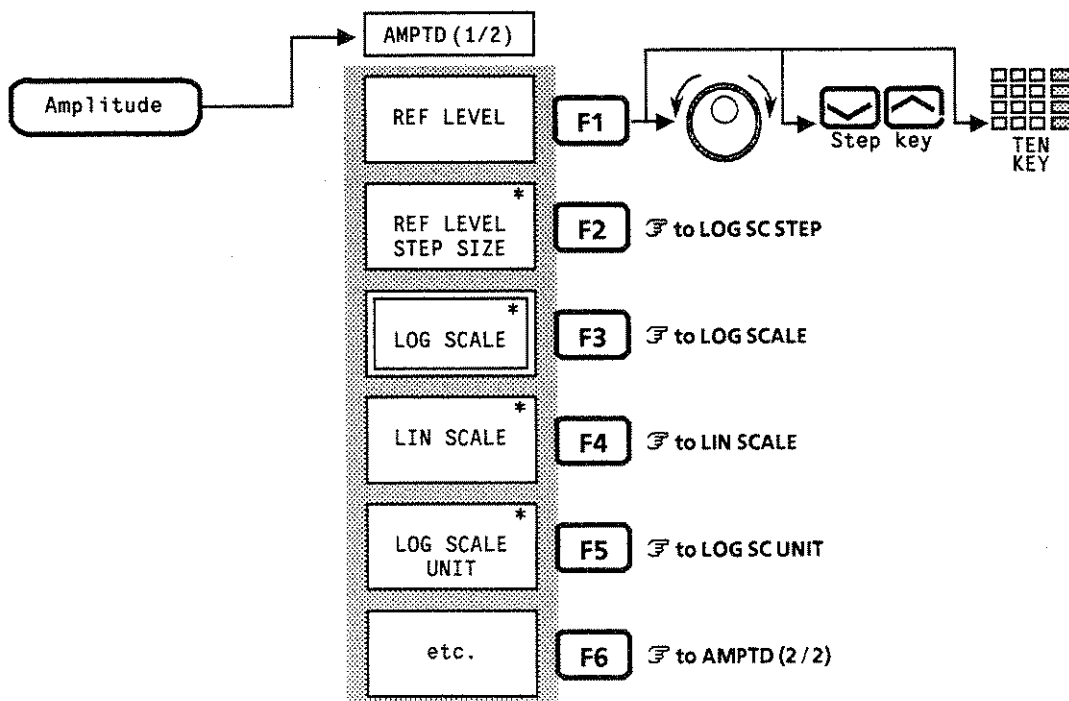

Displays the menu for setting the reference level offset
Displays the menu for setting the correction
Displays the menu for setting the display line
No function
No function
Displays the AMPTD (1 / 2) menu. ↻ to AMPTD (1 / 2)

AMPTD (2/2)
REF LEVEL * OFFSET
CORRECTION *
DISPLAY * LINE
etc.

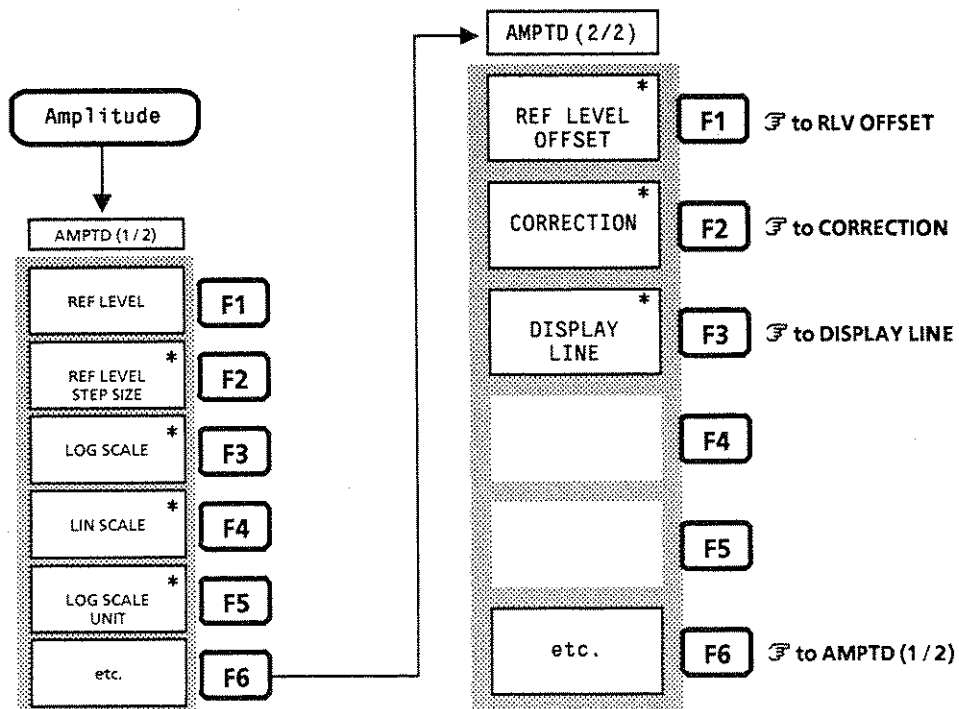

Indicates that the ATTN function is set in MANUAL mode. Pressing this key in AUTO mode changes to MANUAL mode.
Indicates that the ATTN function is set in AUTO mode. Pressing this key in MANUAL mode changes to AUTO mode.
No function
No function
No function
All the values of the coupled function return to AUTO control

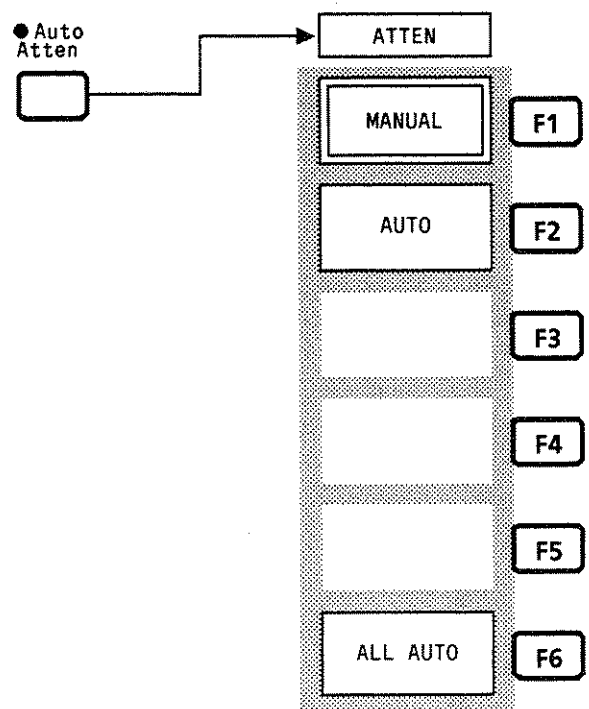
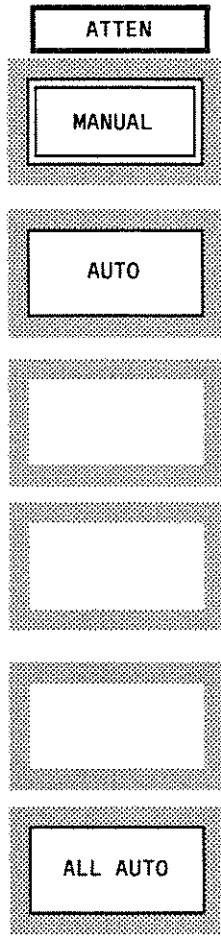

Sets the RS-232C data baud rate to 9600 bps	BAUD RATE 1 9600
Sets the RS-232C data baud rate to 4800 bps	4800
Sets the RS-232C data baud rate to 2400 bps	2400
Sets the RS-232C data baud rate to 1200 bps	1200
Displays the menu 2 setting baud rate. ↩ to BAUD RATE 2	etc.
Returns to the preceding menu. ↩ to RS232C	RETURN

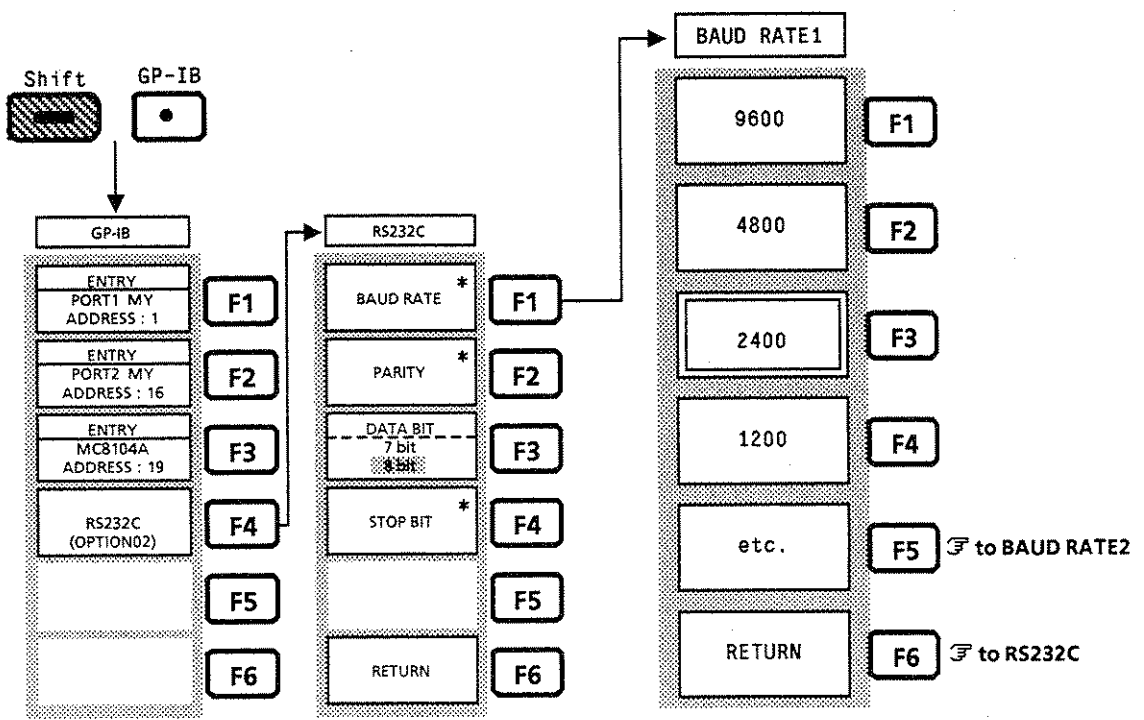

Sets the RS-232C data baud rate to 600 bps
Sets the RS-232C data baud rate to 300 bps
No function
No function
Displays the menu 1 for setting baud rate. ↵ to BAUD RATE 1
Returns to the preceding menu. ↵ to RS232C

BAUD RATE2
600
300
etc.
RETURN

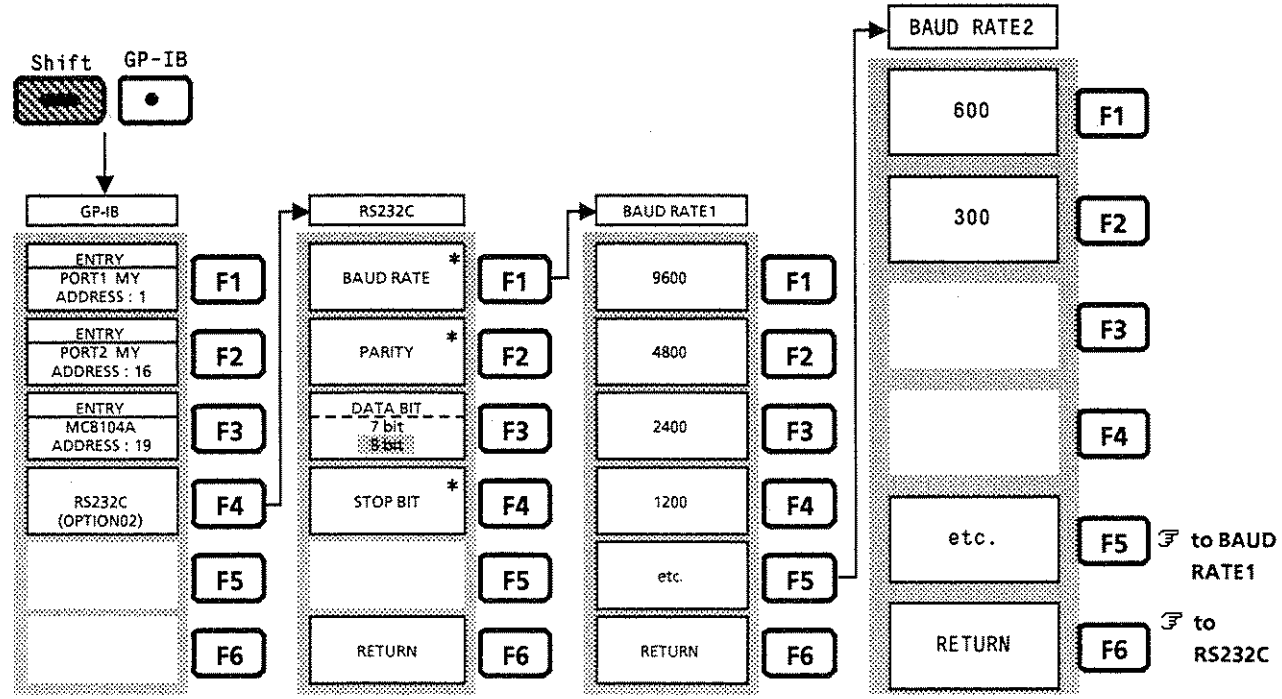

BAUD RATE2

Executes all error corrections (error correction for the level including reference level accuracy and error correction for reading frequency)
Executes error correction for level
Executes error correction for reading frequency
No function
No function
Displays the menu for setting the preselector peaking bias. ☞ to PRESEL TUNE

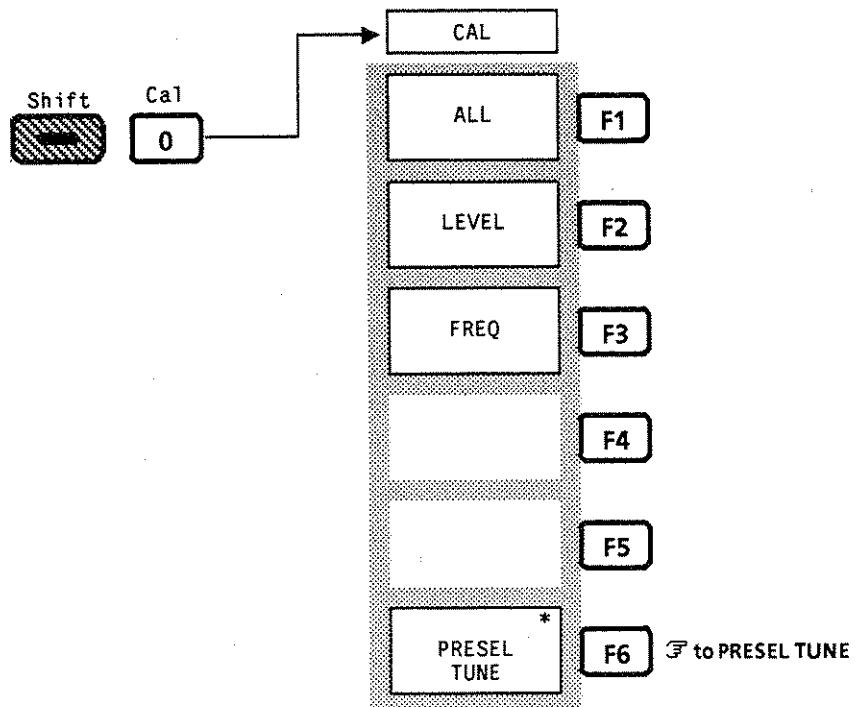
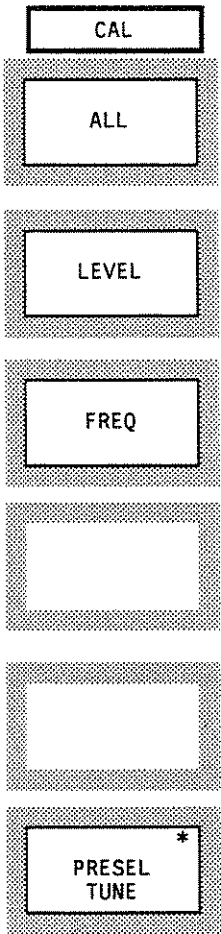

Executes the limit line initialization
No function
No function
No function
No function
Returns to the preceding menu. ↻ to DRAW LINE

CLEAR LINE
APPLY
RETURN

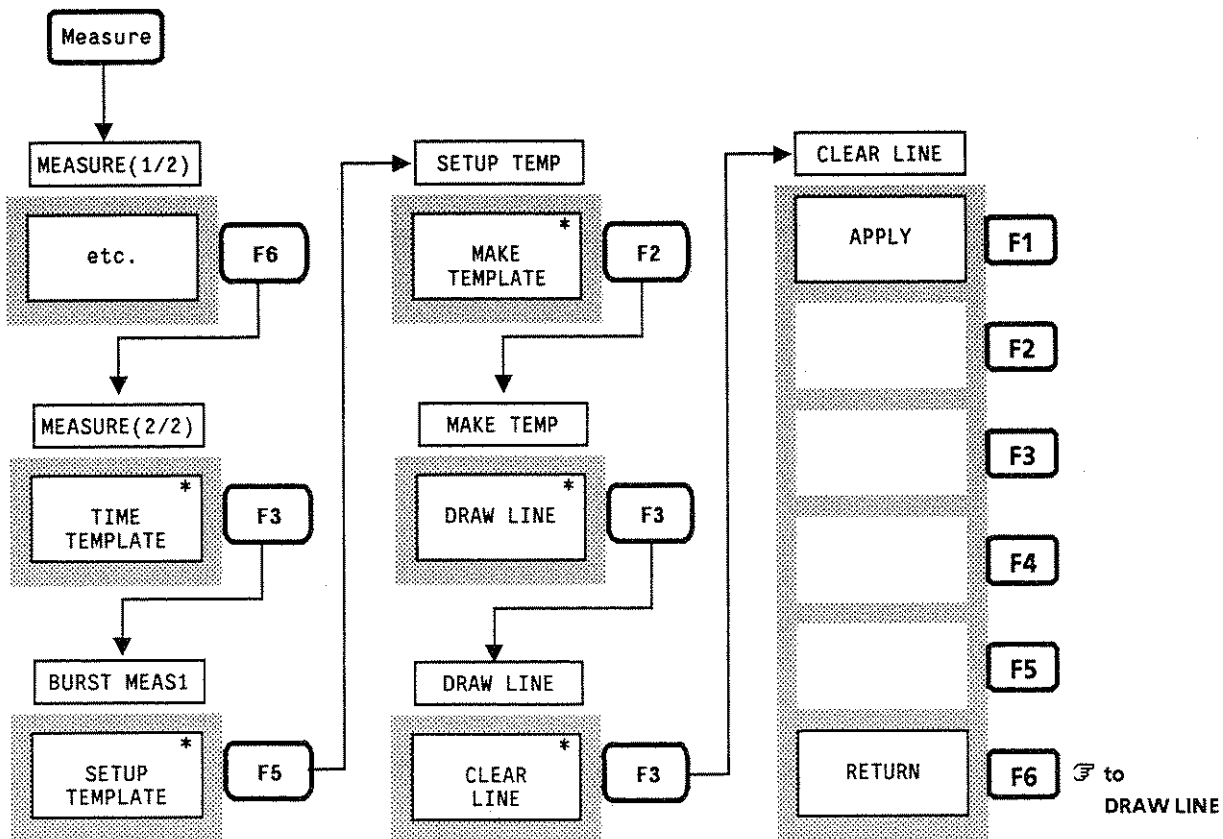

Selects either the printer or the plotter
Displays the menu for selecting the printer to use and for setting its GPIB address. F to SETUP PTR
Sets up the plotter F to SETUP PLTR
Initializes auto-location when output to a plotter
No function
No function

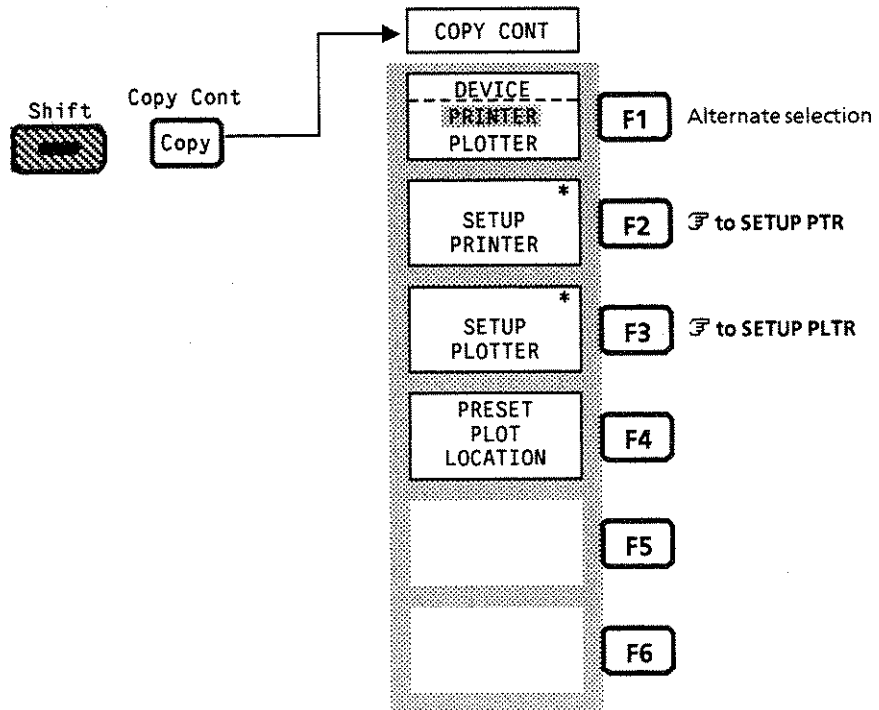
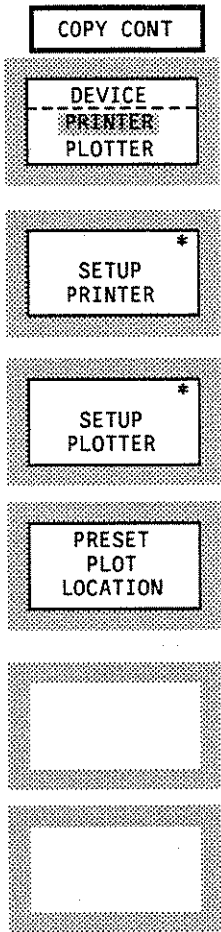

Turns correction ON or OFF (level frequency response correction)
Displays the correction selection menu. F2 to SELECT CORR
No function
No function
No function
Returns to the preceding menu. F6 to AMPTD (2 / 2)

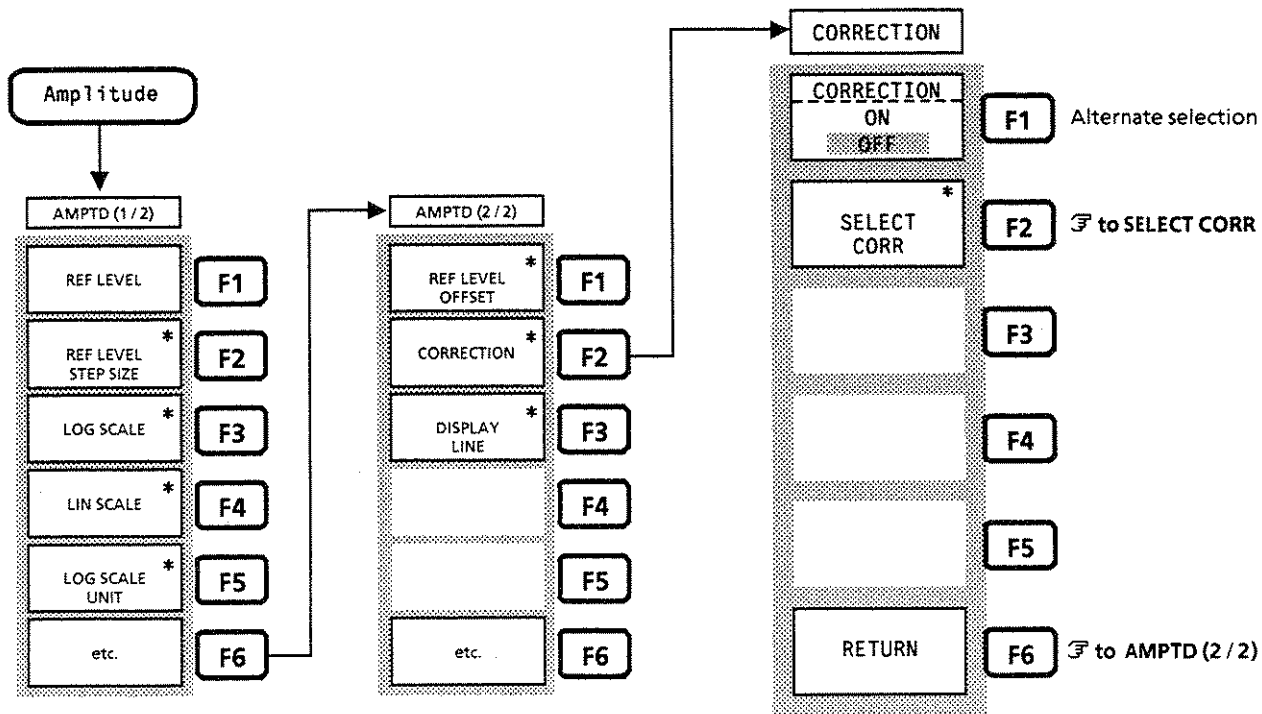
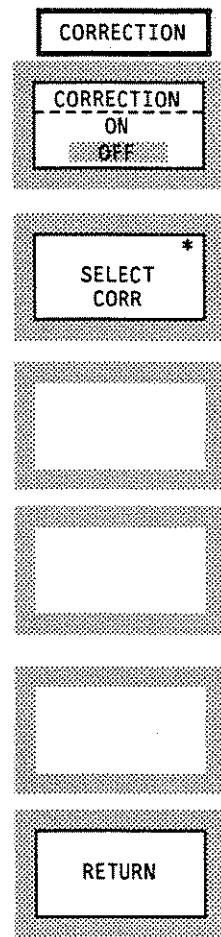

<p>Sets the trace A storage mode to CUMULATIVE. CUMULATIVE: Displays cumulative waveform at each sweep.</p>	<div style="border: 1px solid black; padding: 2px; text-align: center;">CUM/OVER</div> <div style="border: 1px solid black; padding: 2px; text-align: center;">CUMULATIVE</div>
<p>Sets the trace A storage mode to OVERWRITE. OVERWRITE: Displays waveform overwritten without deleting previous trace data.</p>	<div style="border: 1px solid black; padding: 2px; text-align: center;">OVERWRITE</div>
No function	<div style="border: 1px solid black; width: 100px; height: 30px;"></div>
No function	<div style="border: 1px solid black; width: 100px; height: 30px;"></div>
No function	<div style="border: 1px solid black; width: 100px; height: 30px;"></div>
<p>Returns to the preceding menu. \mathcal{F} to TRACE-A</p>	<div style="border: 1px solid black; padding: 2px; text-align: center;">RETURN</div>

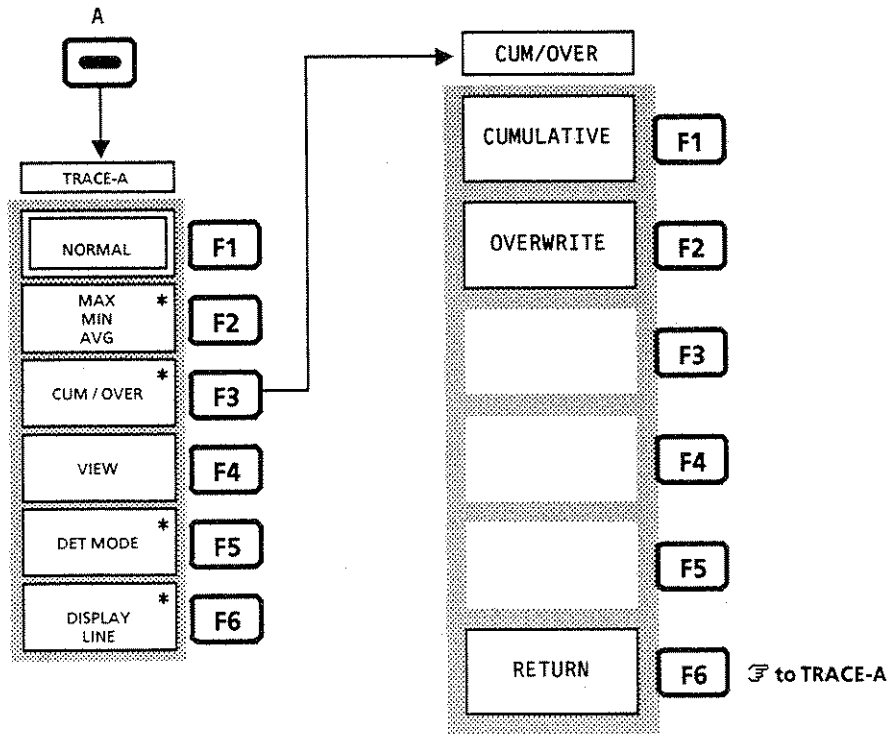

<p>Sets the trace B storage mode to CUMULATIVE. CUMULATIVE: Displays cumulative waveform at each sweep.</p>
<p>Sets the trace B storage mode to OVERWRITE. OVERWRITE: Displays waveform overwritten without deleting previous trace data.</p>
No function
No function
No function
<p>Returns to the preceding menu. \mathcal{F} to TRACE-B</p>

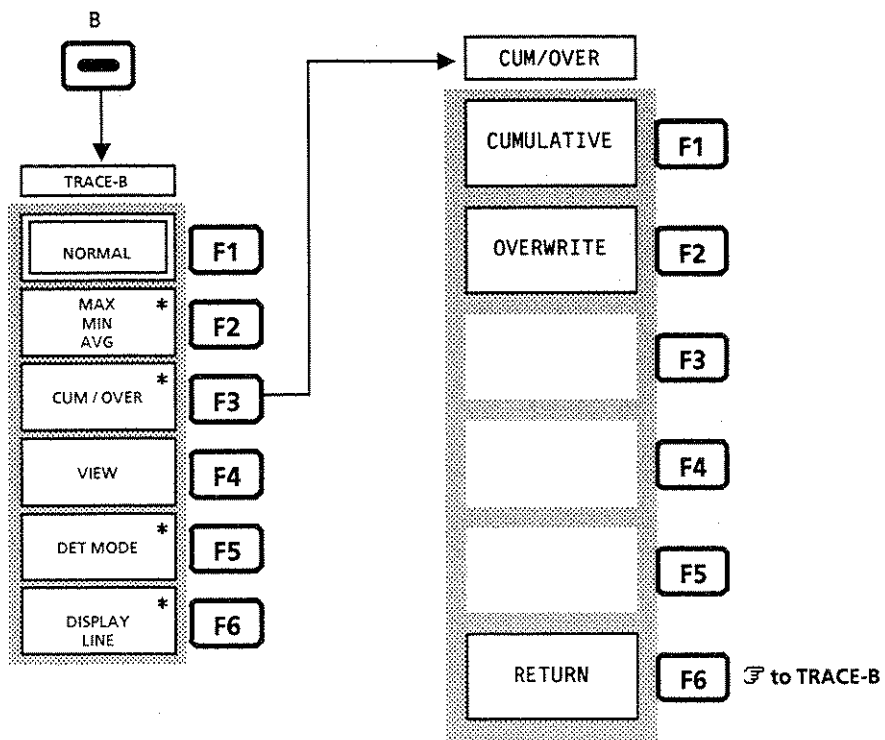
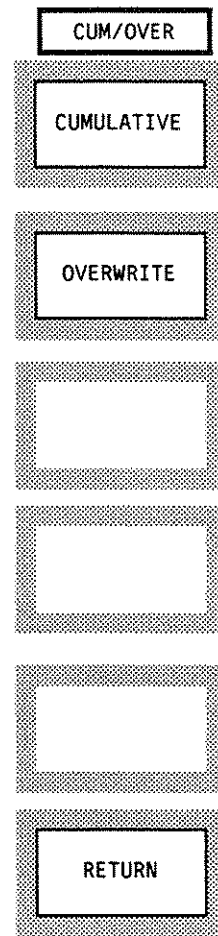

Sets the trace TIME storage mode to CUMULATIVE. CUMULATIVE: Displays cumulative waveform at each sweep.
Sets the trace TIME storage mode to OVERWRITE. OVERWRITE: Displays waveform overwritten without deleting previous trace data.
No function
No function
No function
Returns to the preceding menu. ↻ to STORAGE MODE

CUM/OVER
CUMULATIVE
OVERWRITE
RETURN

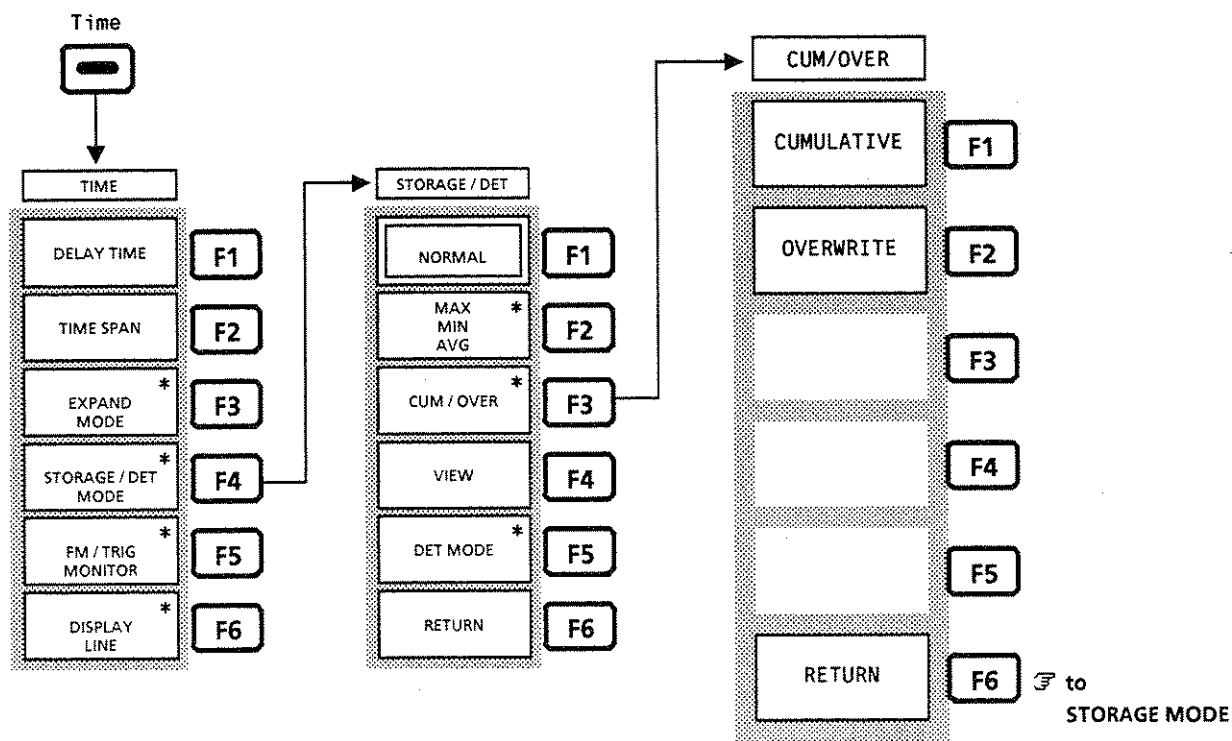

Input the date.	DATE/TIME DATE (YYMMDD)
Input the time.	TIME (HHMMSS)
Set the display format of the date.	DATE DISP YY/MM/DD
No function	
No function	
Returns to the preceding menu. ⇐ to SYSTEM	RETURN

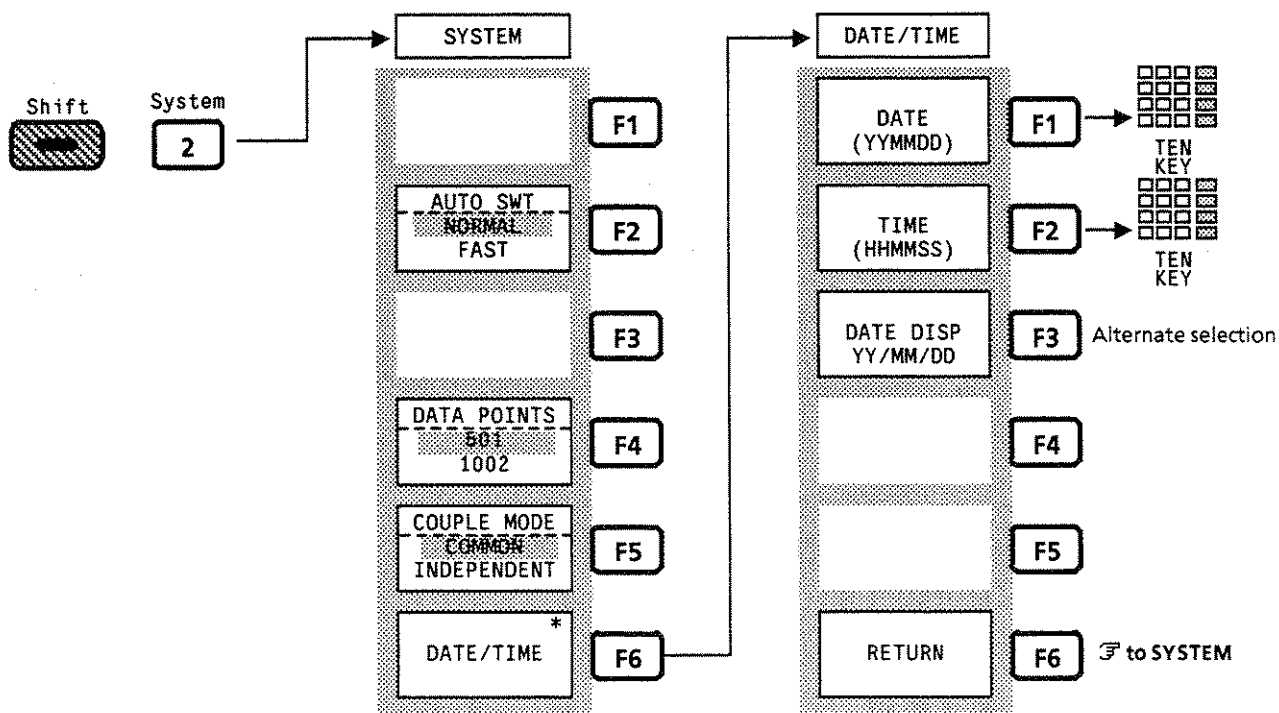

<p>Sets the trace Time detection mode to POSITIVE PEAK. POSITIVE PEAK: Detects positive peak, then traces the maximum value between sample points.</p>
<p>Sets the trace Time detection mode to SAMPLE. SAMPLE: Traces the instantaneous value between sample points.</p>
<p>Sets the trace Time detection mode to NEGATIVE PEAK. NEGATIVE PEAK: Detects negative peak, then traces the minimum value between sample points.</p>
<p>No function</p>
<p>No function</p>
<p>Returns to the preceding menu. ↳ to TRACE-A</p>

DET MODE

POS PEAK

SAMPLE

NEG PEAK

RETURN

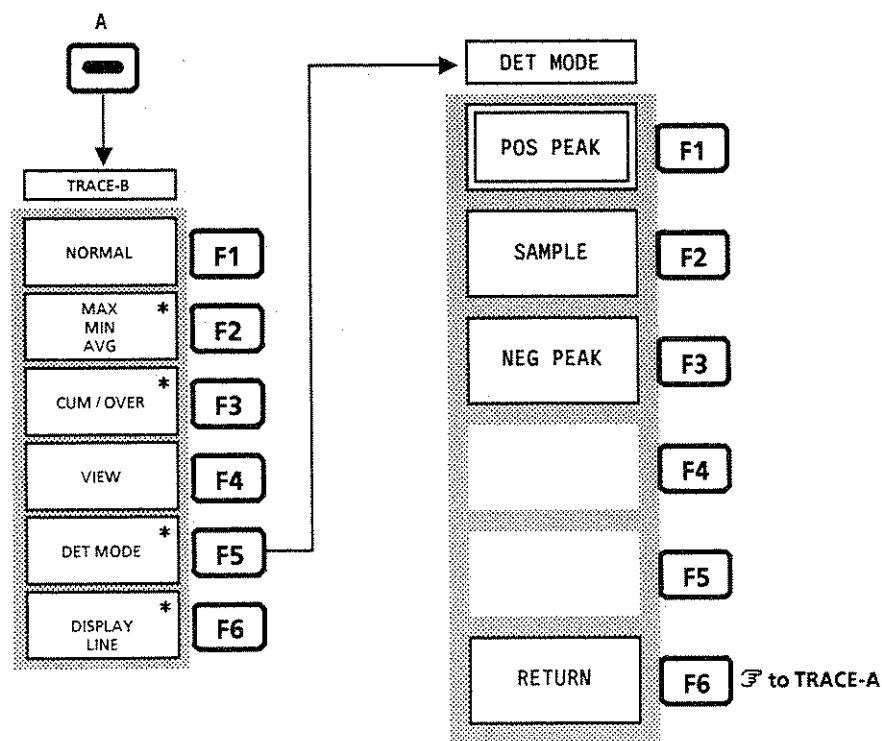

<p>Sets the trace B detection mode to POSITIVE PEAK. POSITIVE PEAK: Detects positive peak, then traces the maximum value in sample points.</p>
<p>Sets the trace B detection mode to SAMPLE. SAMPLE: Traces the instantaneous value in sample points.</p>
<p>Sets the trace B detection mode to NEGATIVE PEAK. NEGATIVE PEAK: Detects negative peak, then traces the minimum value in sample points.</p>
<p>No function</p>
<p>No function</p>
<p>Returns to the preceding menu. \mathcal{F} to TRACE-B</p>

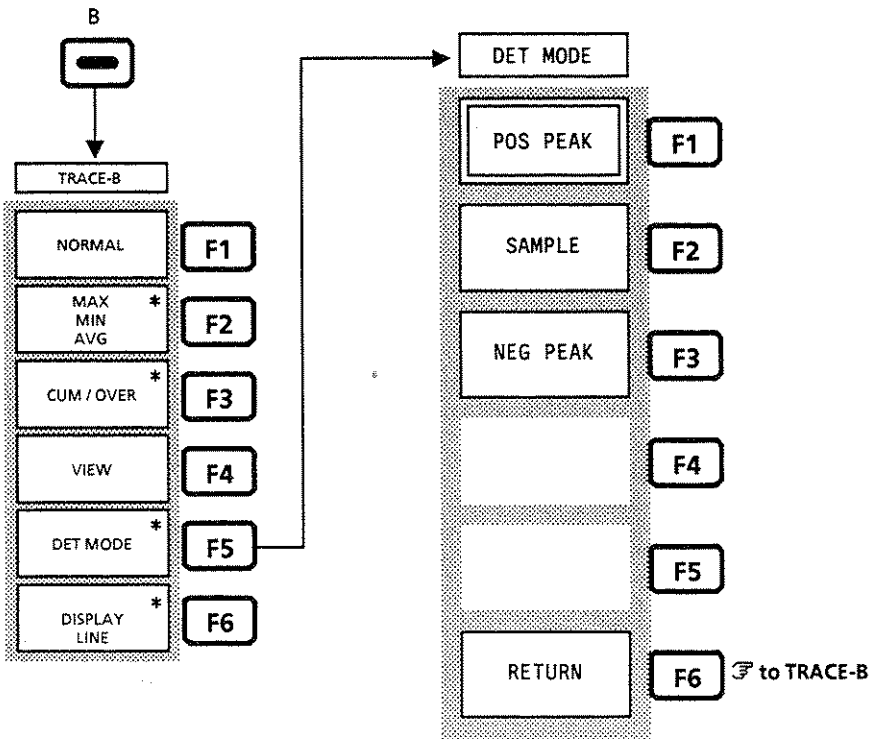
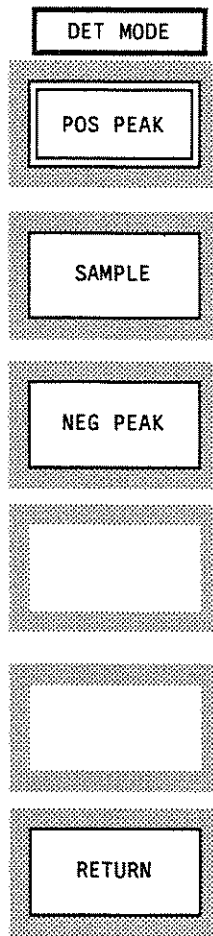

<p>Sets the trace Time detection mode to POSITIVE PEAK. POSITIVE PEAK : Detects positive peak, then traces the maximum value between sample points.</p>
<p>Sets the trace Time detection mode to SAMPLE. SAMPLE : Traces the instantaneous value between sample points.</p>
<p>Sets the trace Time detection mode to NEGATIVE PEAK. NEGATIVE PEAK : Detects negative peak, then traces the minimum value between sample points.</p>
<p>No function</p>
<p>No function</p>
<p>Returns to the preceding menu. ↵ to STORAGE/DET</p>

- DET MODE
- POS PEAK
- SAMPLE
- NEG PEAK
-
-
- RETURN

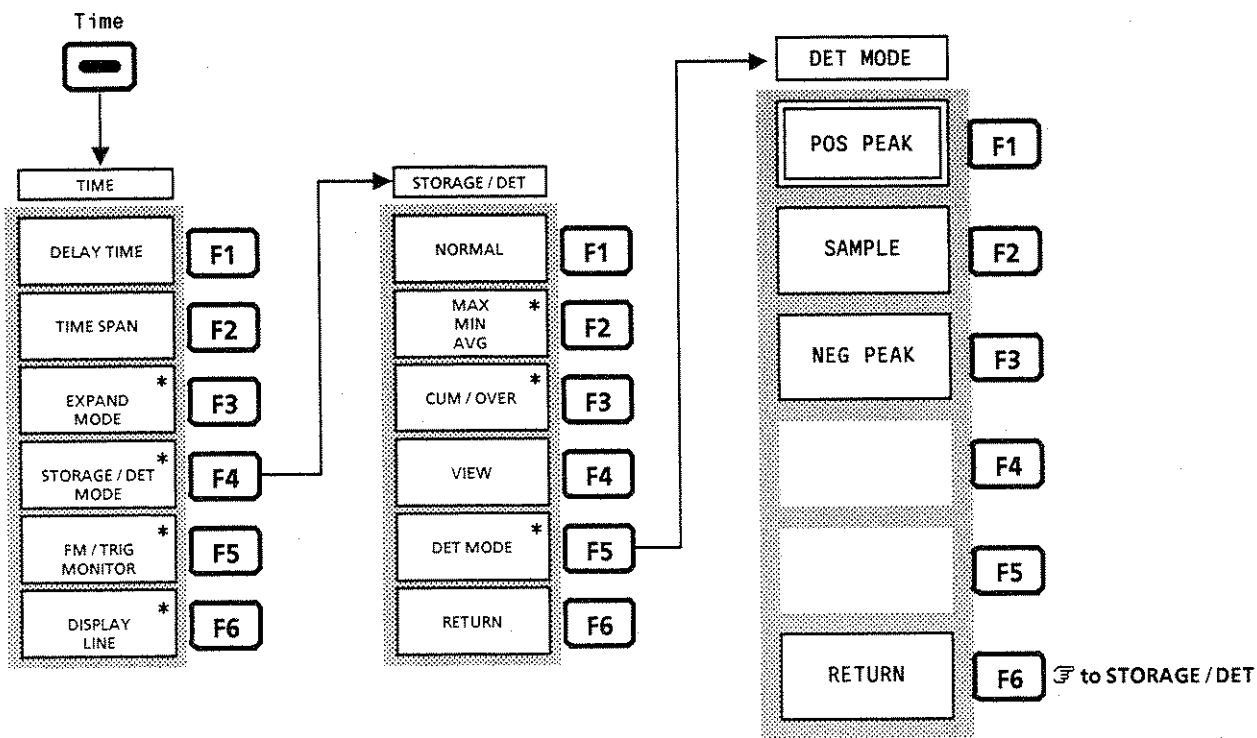

Selects the trace data file for the directory display, write protection, and deletion of the file. ↗ to TRACE FILES
No function
No function
No function
No function
Returns to the preceding menu. ↗ to PMC

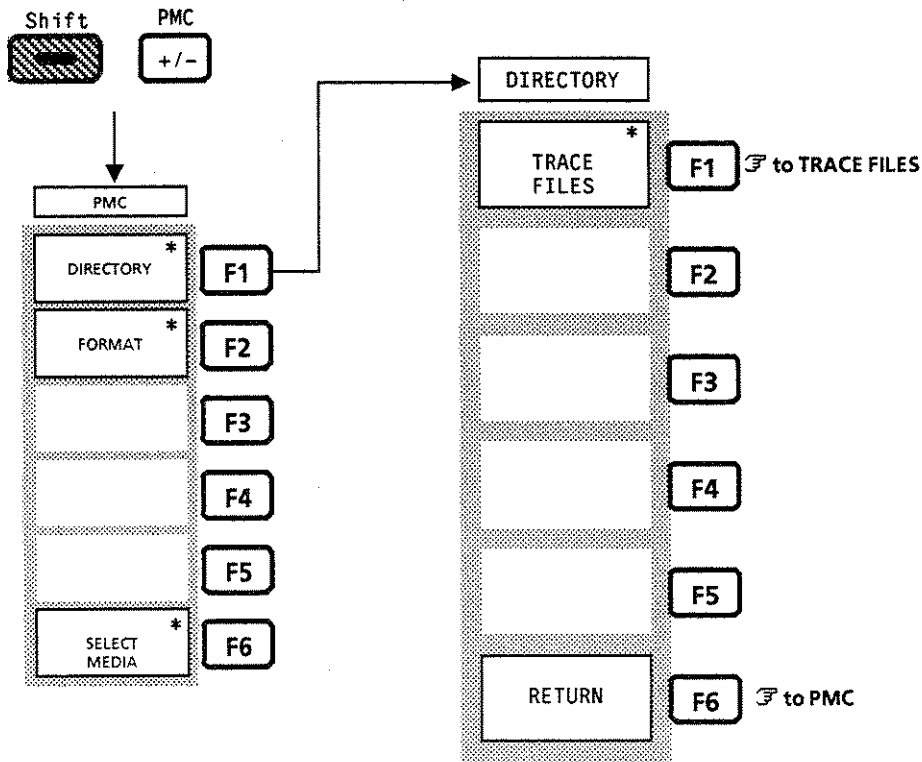
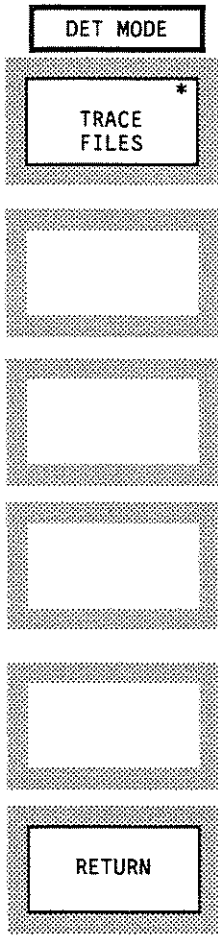

Turns the display line ON or OFF
Sets the display line level
Selects the marker level reading (absolute value or relative value referred to display line) when display line is ON
No function
No function
Returns to the preceding menu. ↩ to AMPTD (2 / 2)

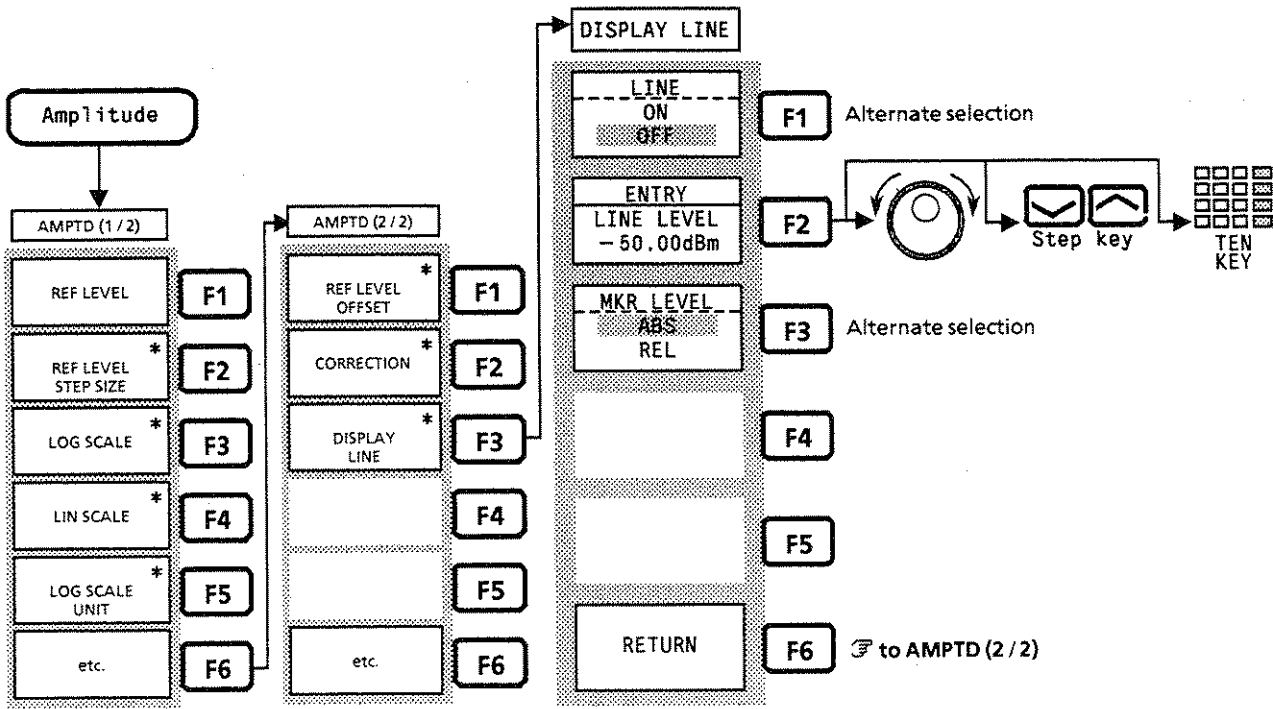
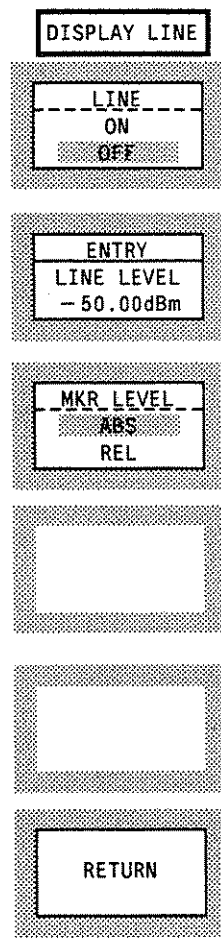

Turns the display line ON or OFF
Sets the display line level
Selects the marker level reading (absolute value or relative value referred to display line) when display line is ON
No function
No function
Returns to the preceding menu. ↩ to TRACE-A

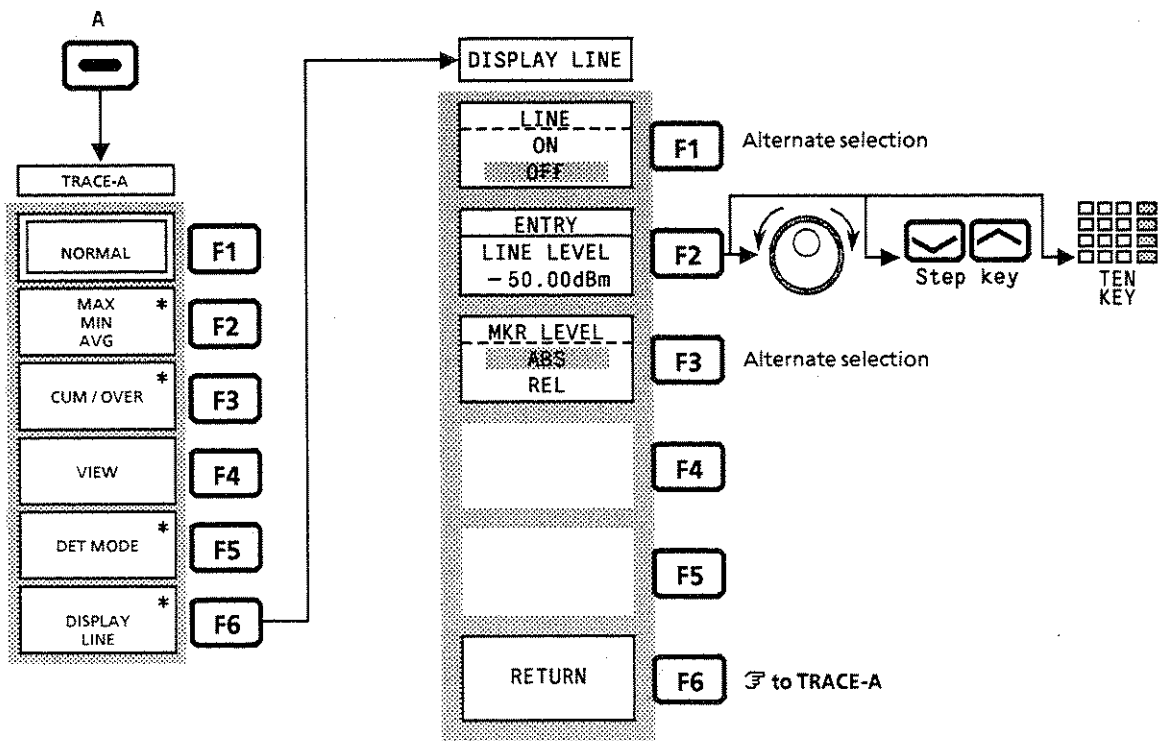
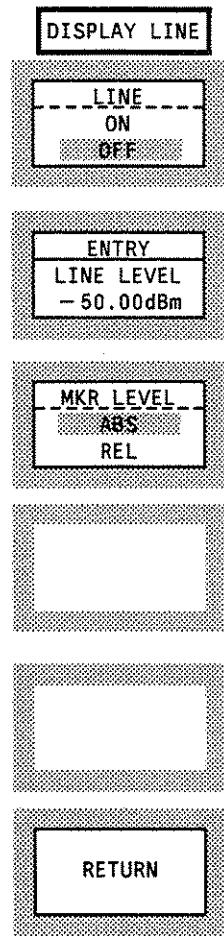

Turns the display line ON or OFF
Sets the display line level
Selects the marker level reading (absolute value or relative value referred to display line) when display line is ON
No function
No function
Returns to the preceding menu. ↶ to TRACE-B

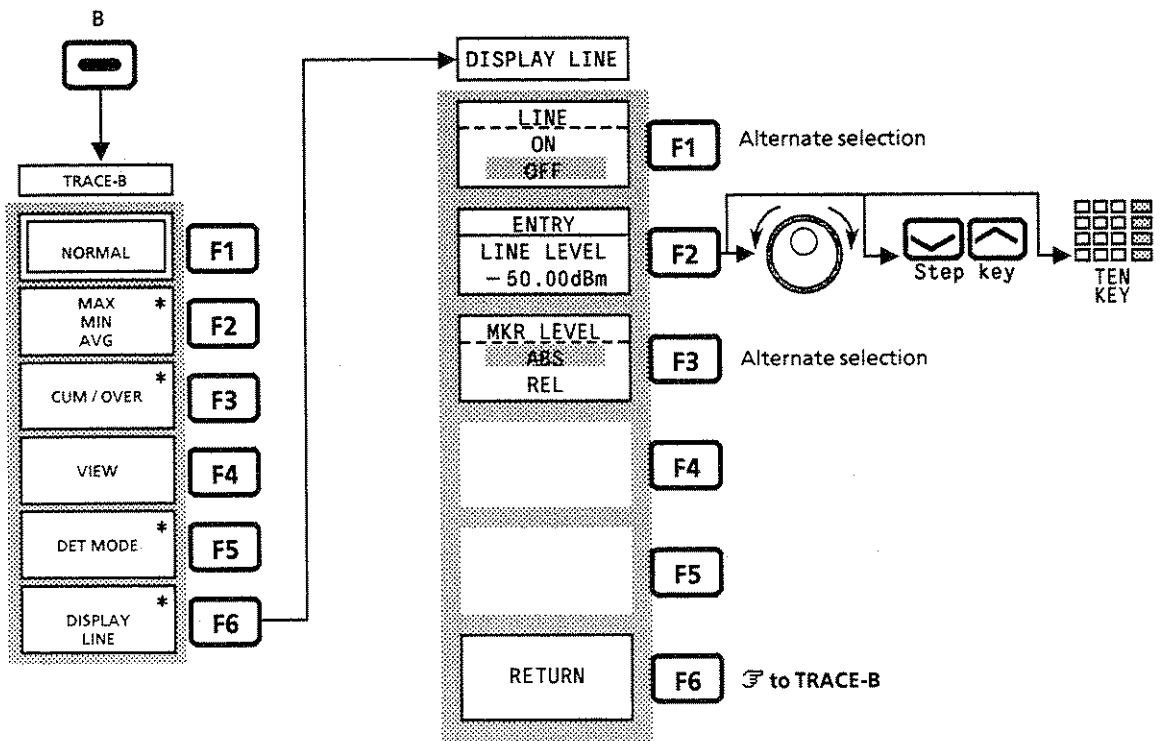
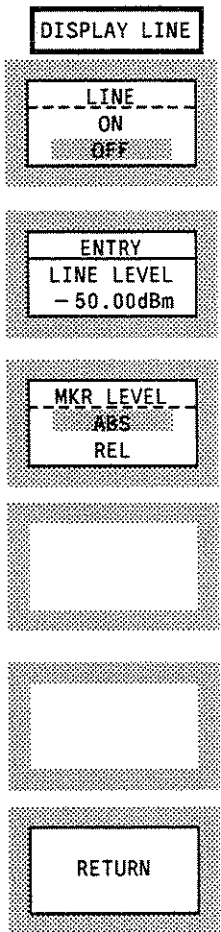

Turns the display line ON or OFF
Sets the display line level
Selects the marker level reading (absolute value or relative value referred to display line) when display line is ON
No function
No function
Returns to the preceding menu. ↩ to TIME

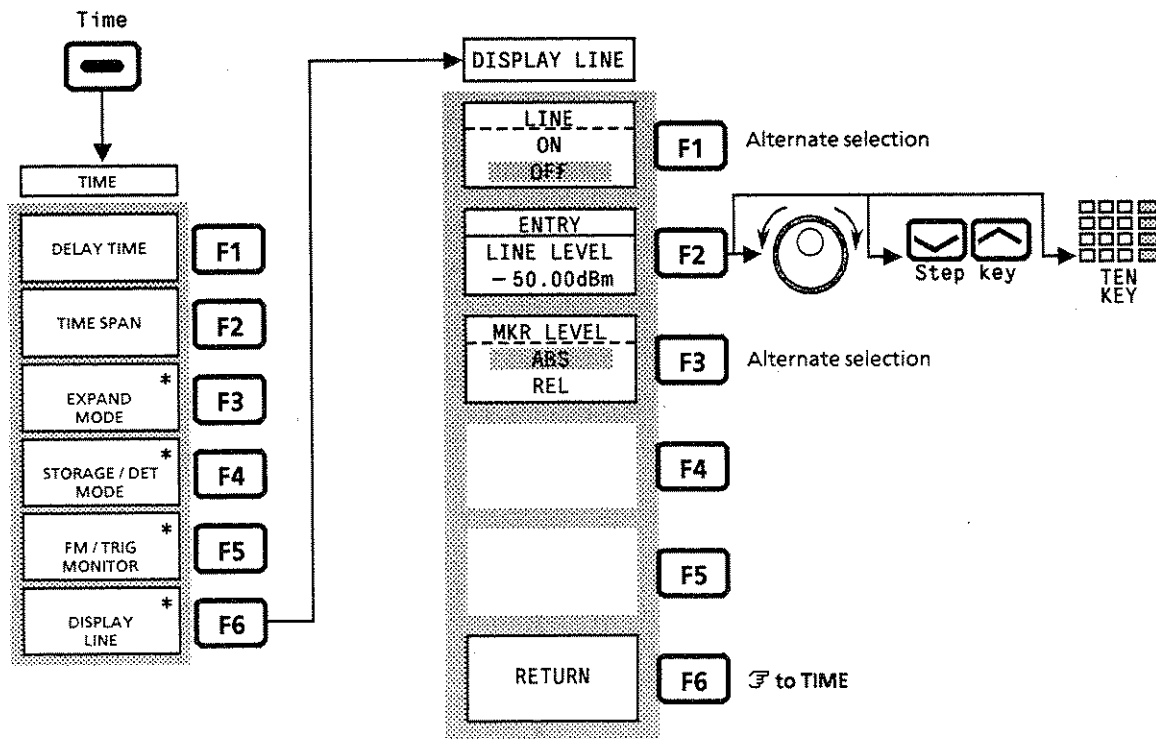
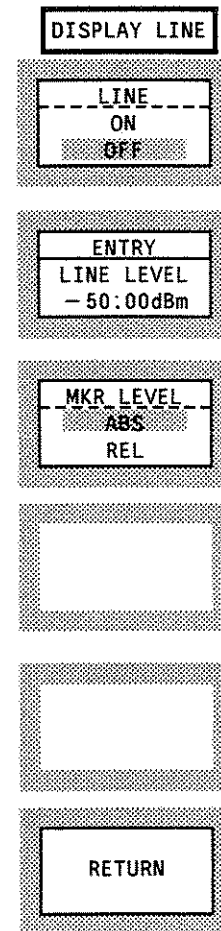

Selects the template data entry mode for INSERT or REPLACE
Deletes the template data
Clears the limit line data. F3 to CLEAR LINE
Selects the template data display mode for GRAPH or LIST
Switches the list page to the next page when the template data is displayed on the screen
Returns to the preceding menu. F6 to MAKE TEMP

- DRAW LINE
- INPUT MODE
INSERT
REPLACE
- DELETE
- CLEAR LINE *
- FORMAT
GRAPH
LIST
- NEXT PAGE
- RETURN

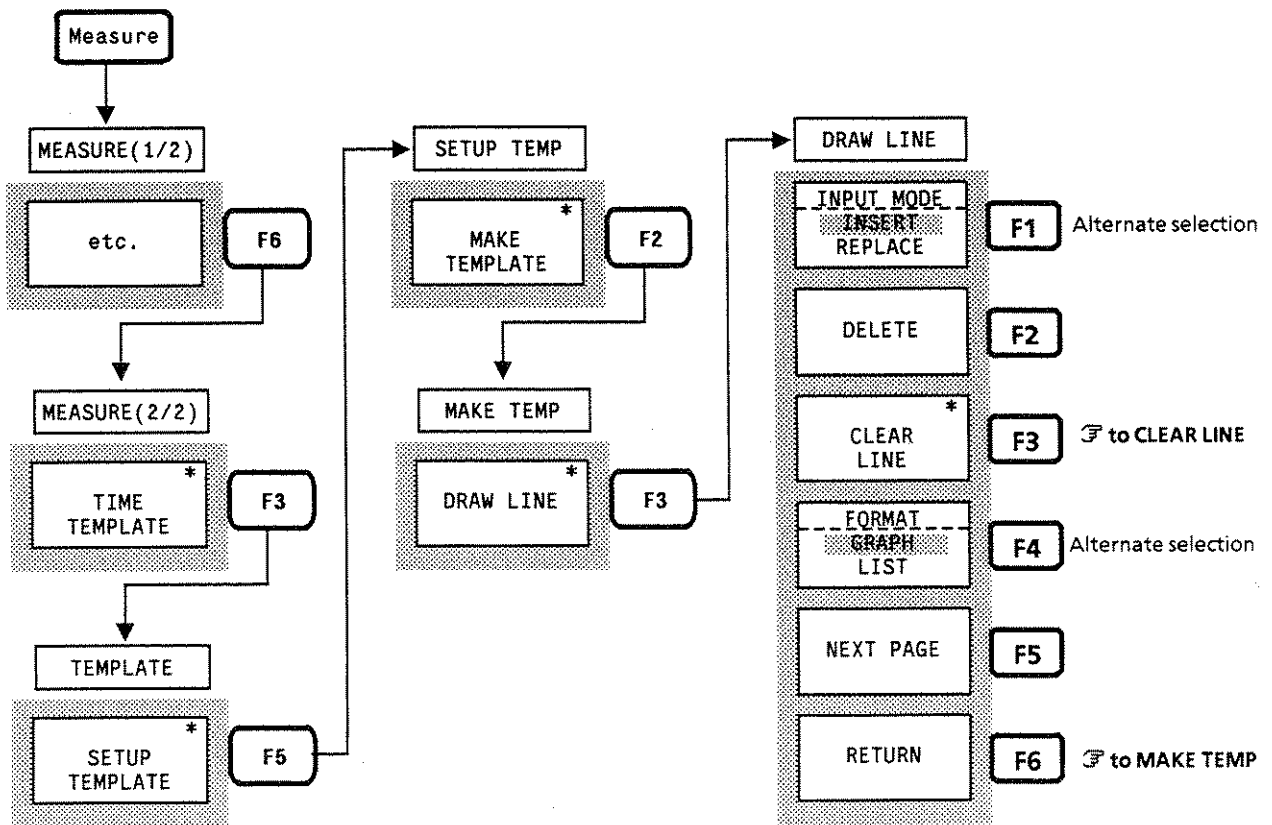

Sets the EXPAND ZONE start
Sets the EXPAND ZONE span
Sets the EXPAND ZONE to ON / OFF
Sets the EXPAND to ON / OFF
No function
Returns to the preceding menu. ↶ to TIME

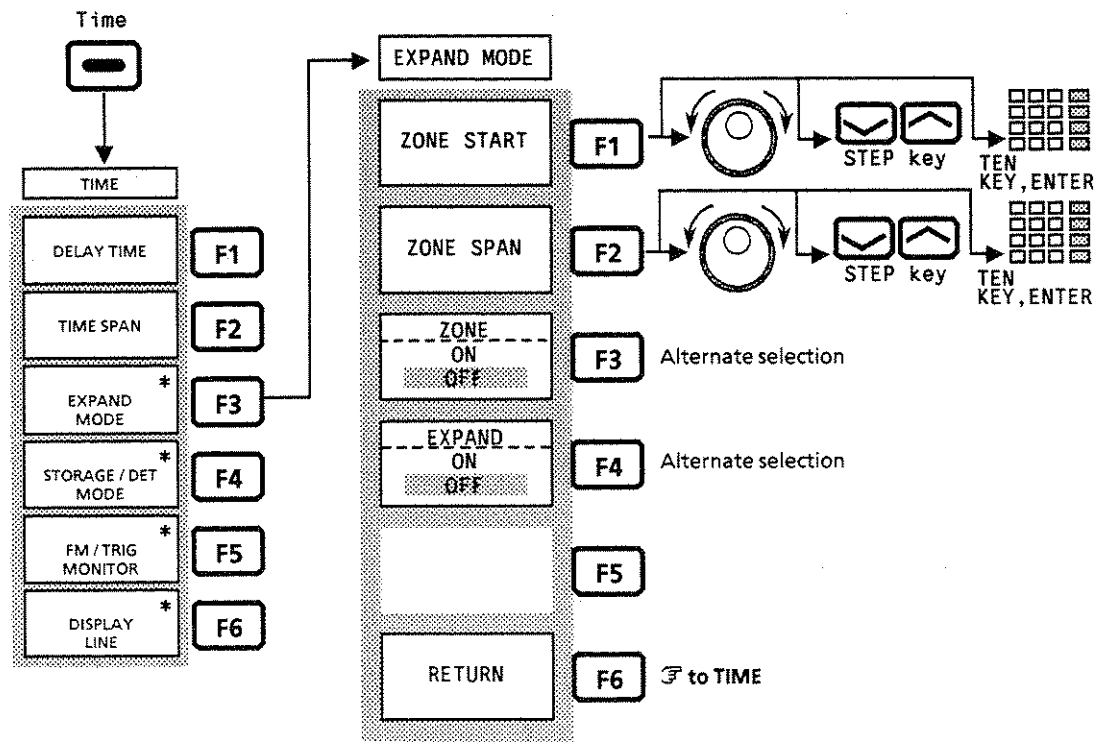
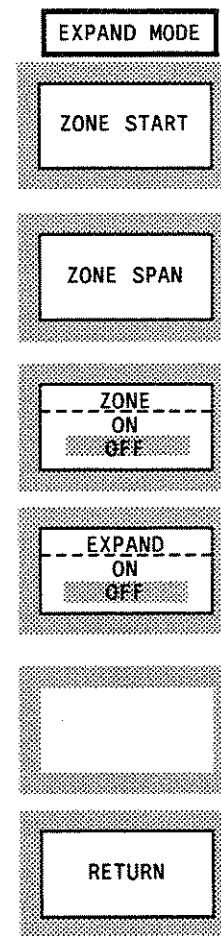

EXPAND MODE

Sets the external trigger input connector to INPUT 1 ($\pm 10V$)	EXT TRIG
Sets the external trigger input connector to INPUT 2 (TTL)	INPUT 1 ($\pm 10V$)
No function	INPUT 2 (TTL)
No function	
No function	
No function	
Returns to the preceding menu. ↻ to TRIG SOURCE	RETURN

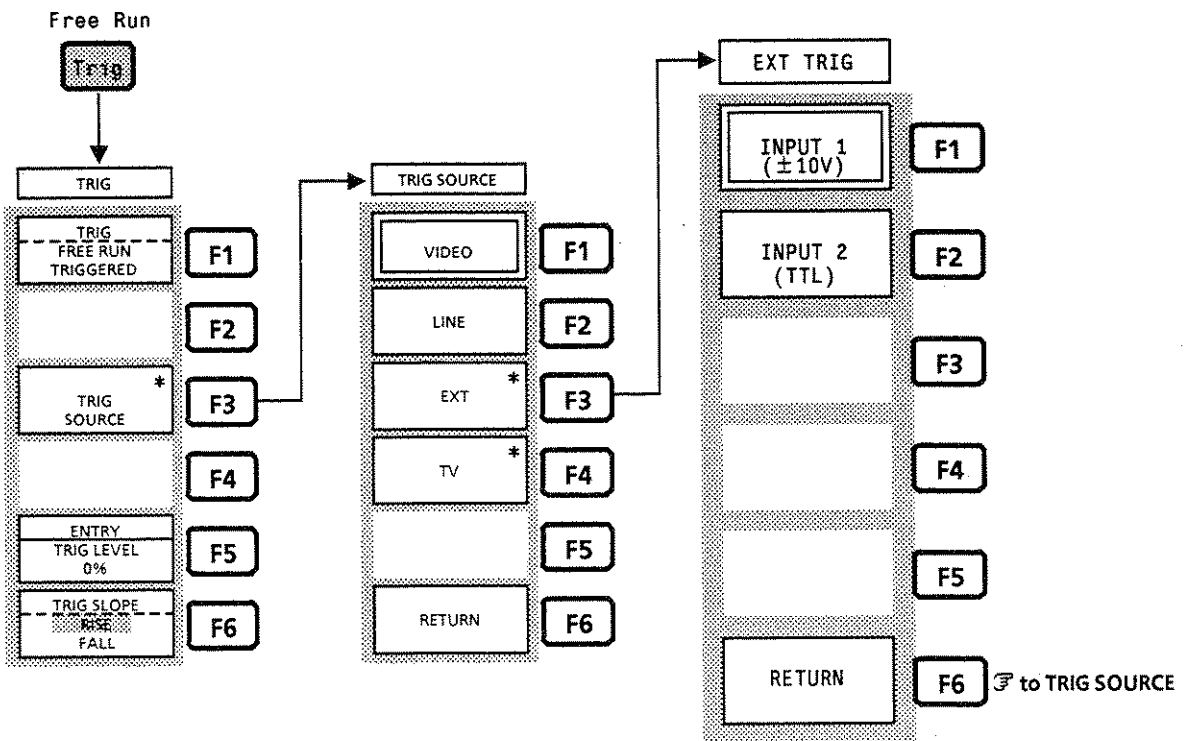

Sets the FINE ADJ to ON / OFF.
Set the FINE ADJ frequency.
No function
No function
No function
Returns to the preceding menu. ↩ to FREQ (2 / 2)

FINE ADJ

FINE ADJ
ON
OFF

ADJ
-1.5kHz

RETURN

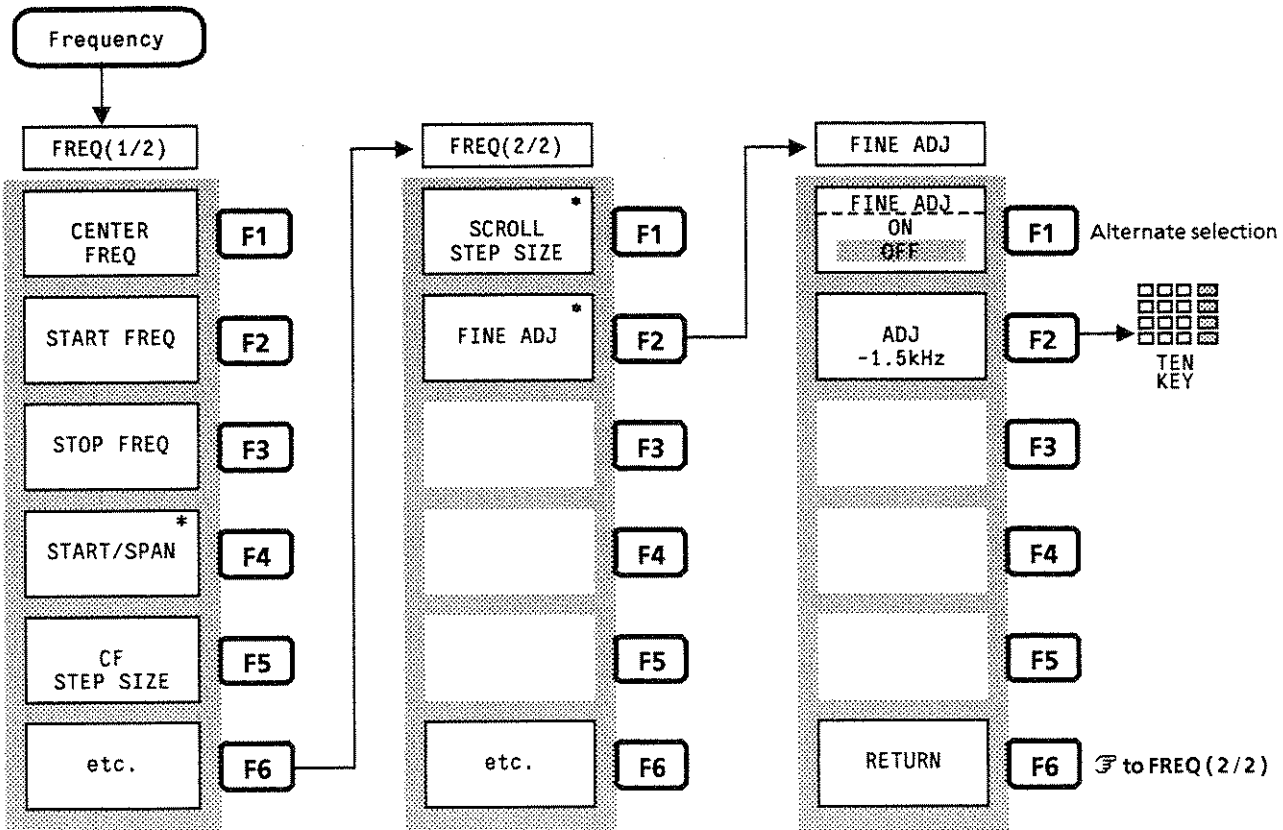

Sets the FM demodulation range to 200 kHz / div	FM
Sets the FM demodulation range to 20 kHz / div	200kHz/div (BW<1MHz)
Sets the FM demodulation range to 2 kHz / div	20kHz/div (BW<50kHz)
No function	2kHz/div (BW<50kHz)
Selects AC / DC coupling	COUPLING AC DC
Returns to the preceding menu. ↶ to MONITOR	RETURN

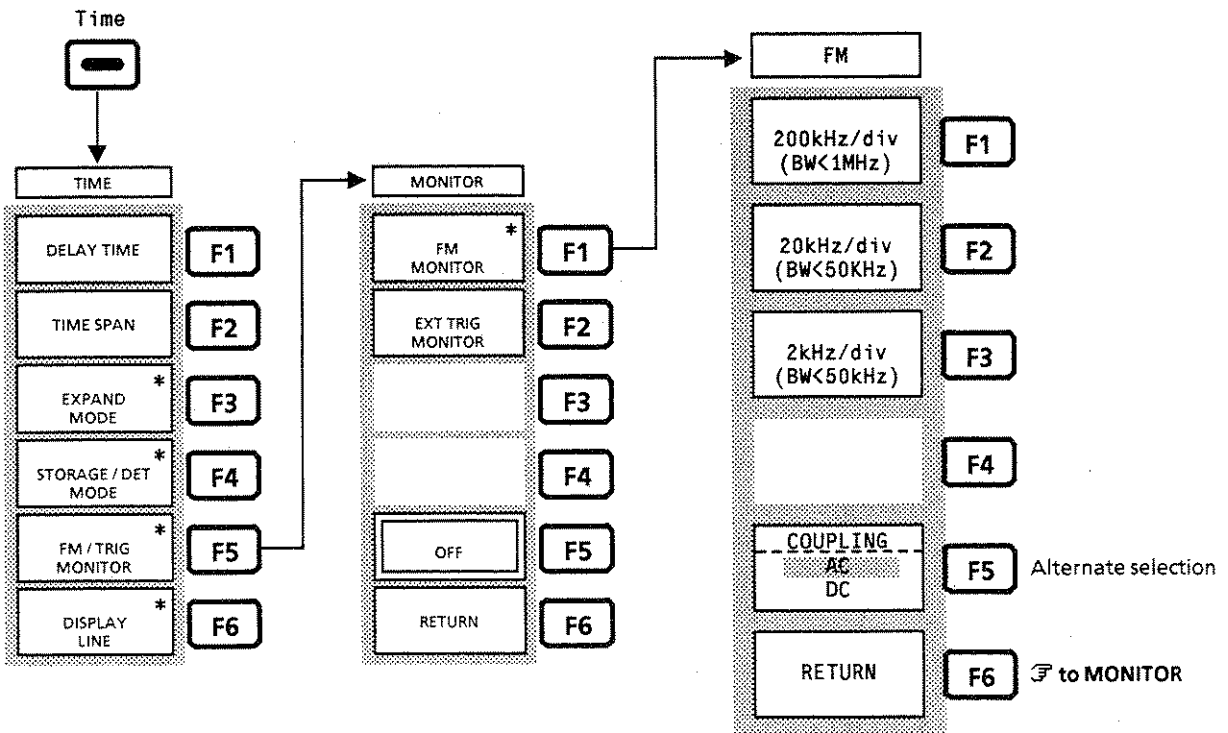

Formats (initializes) the PMC or floppy disk (FD)
No function
No function
No function
No function
Returns to the preceding menu. ⇧ to PMC

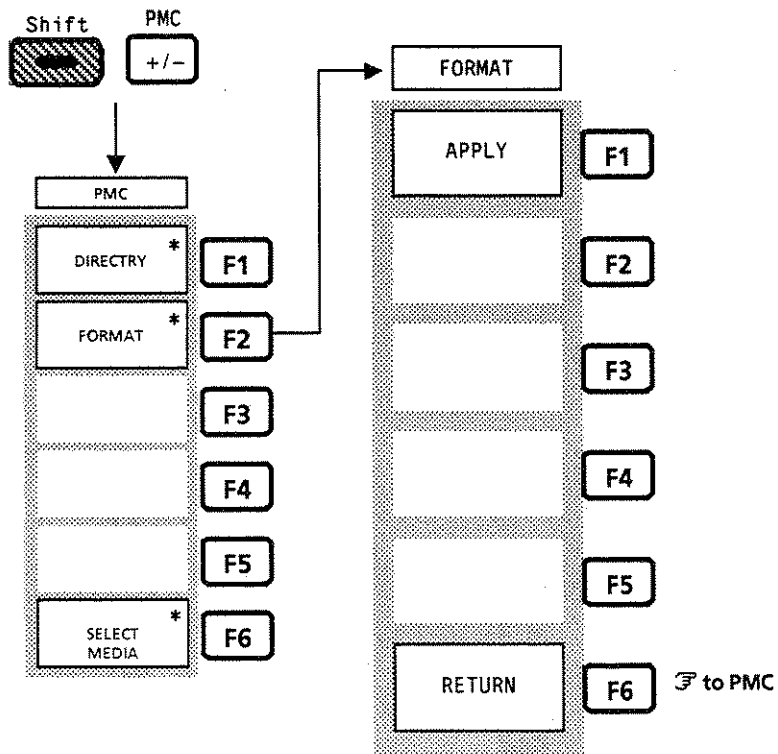
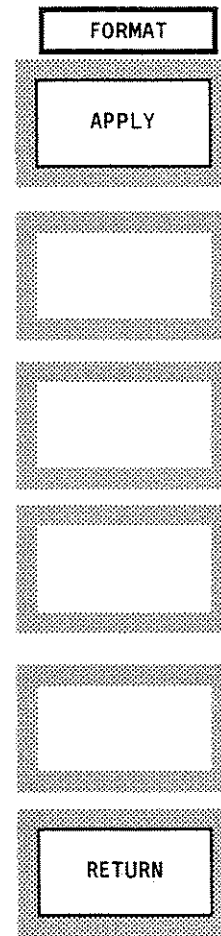

Sets the center frequency	FREQ(1/2) CENTER FREQ
Sets the start frequency	START FREQ
Sets the stop frequency	STOP FREQ
Sets the frequency-observation mode to START / SPAN. ↻ to START / SPAN	START/SPAN *
Registers the center frequency step size	CF STEP SIZE
Displays the FREQ (2 / 2) menu. ↻ to FREQ (2 / 2)	etc.

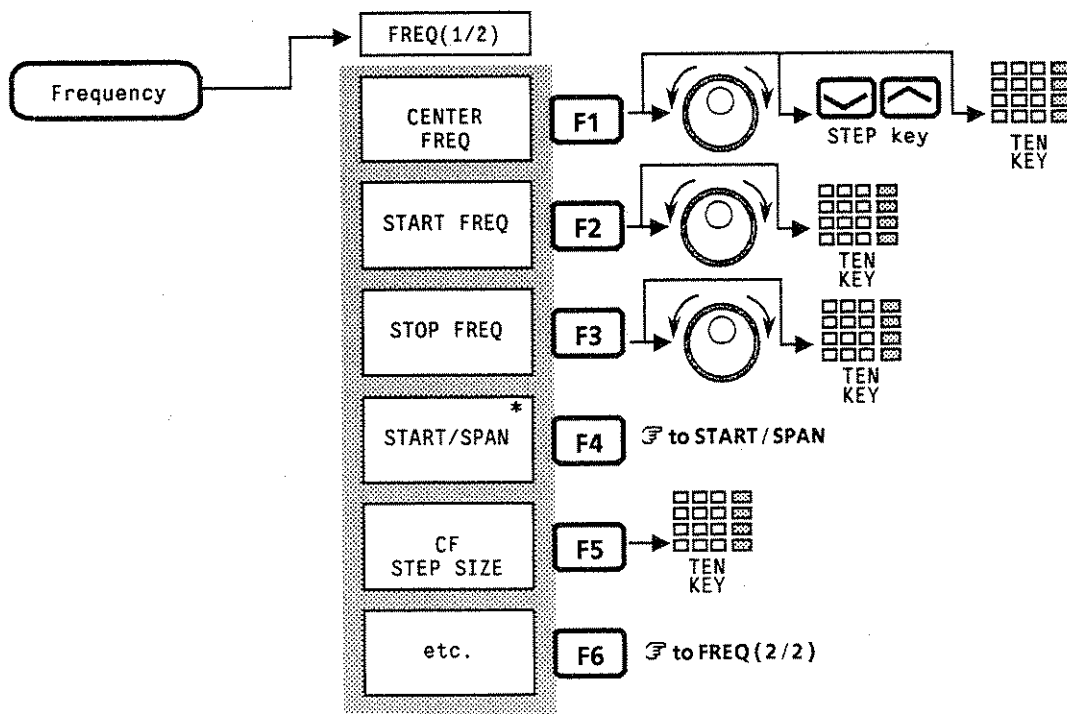

Displays the menu for setting the scroll step size of the observation frequency. F to SCROLL STEP
Display the menu for setting the FINE ADJ frequency. F to FINE ADJ
No function
No function
No function
Displays the FREQ (1 / 2) menu. F to FREQ (1 / 2)

FREQ(2/2)

SCROLL STEP SIZE *

FINE ADJ *

etc.

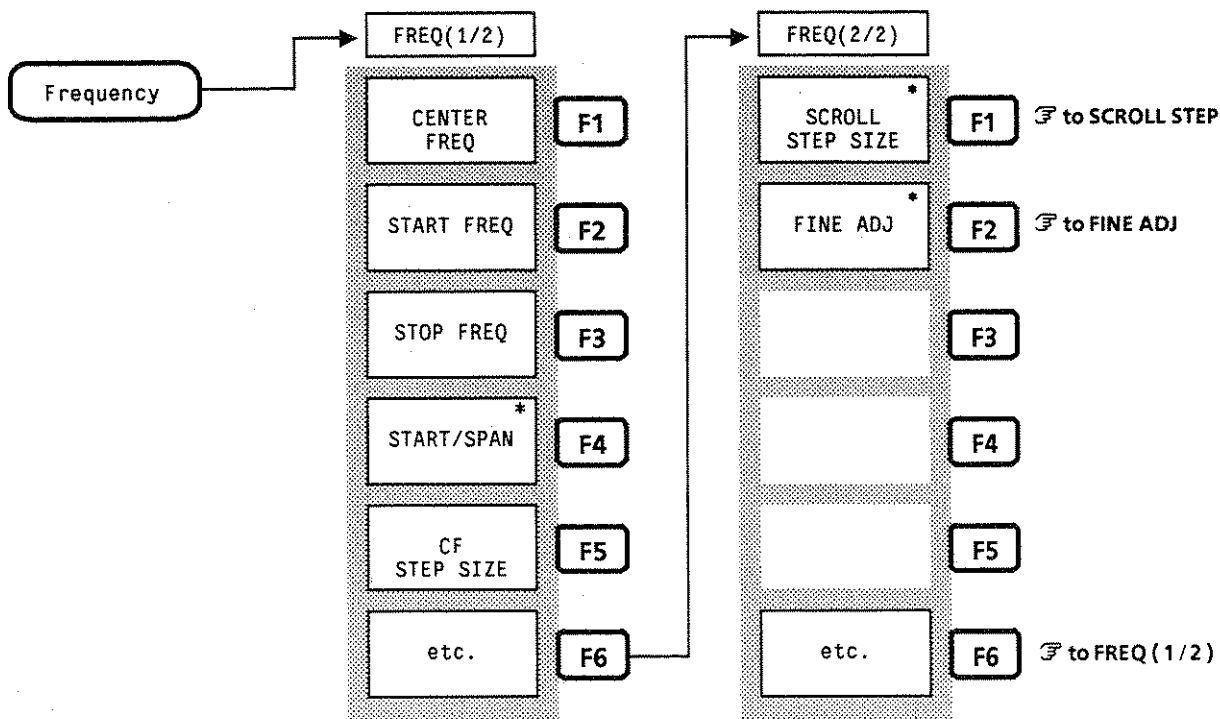

Turns the frequency measurement function (counter function) ON	<div style="border: 1px solid black; padding: 2px; text-align: center;">FREQ MEAS</div> <div style="border: 1px solid black; padding: 2px; text-align: center;">COUNT ON</div>
No function	
No function	
Turns the frequency measurement function (counter function) OFF	<div style="border: 1px solid black; padding: 2px; text-align: center;">OFF</div>
Displays the menu for setting the frequency resolution in frequency measurement. ↻ to RESOLUTION	<div style="border: 1px solid black; padding: 2px; text-align: center;">SETUP *</div>
Returns to the preceding menu. ↻ to MEASURE (1/2)	<div style="border: 1px solid black; padding: 2px; text-align: center;">RETURN</div>

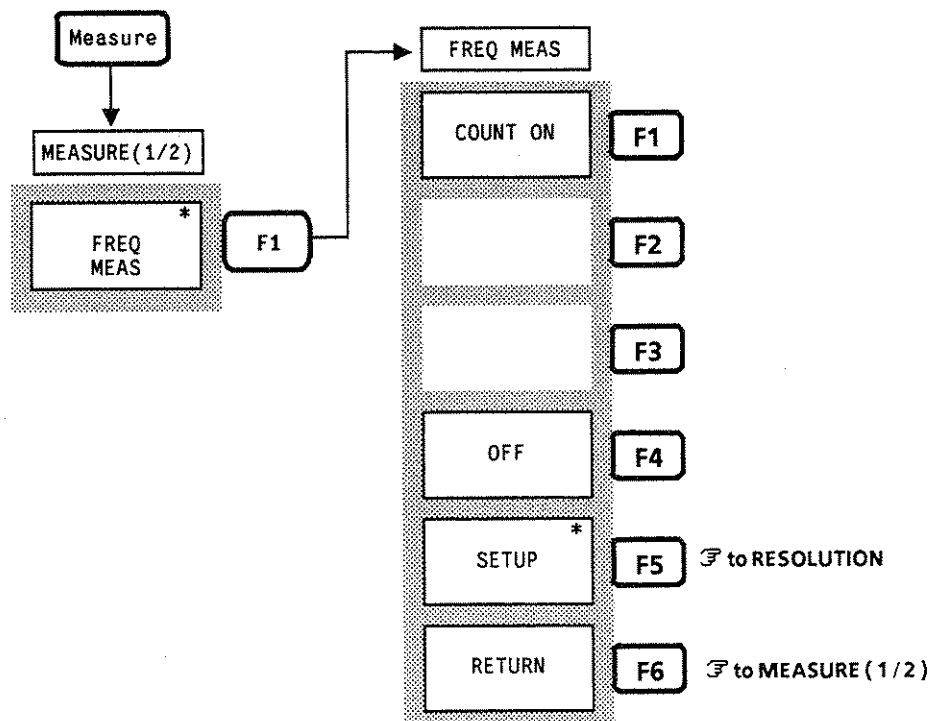

Sets the gate function to ON or OFF
Sets the GATE DELAY value
Sets the GATE LENGTH value
Selects either of the end conditions of the gate control for INT or EXT
No function
No function

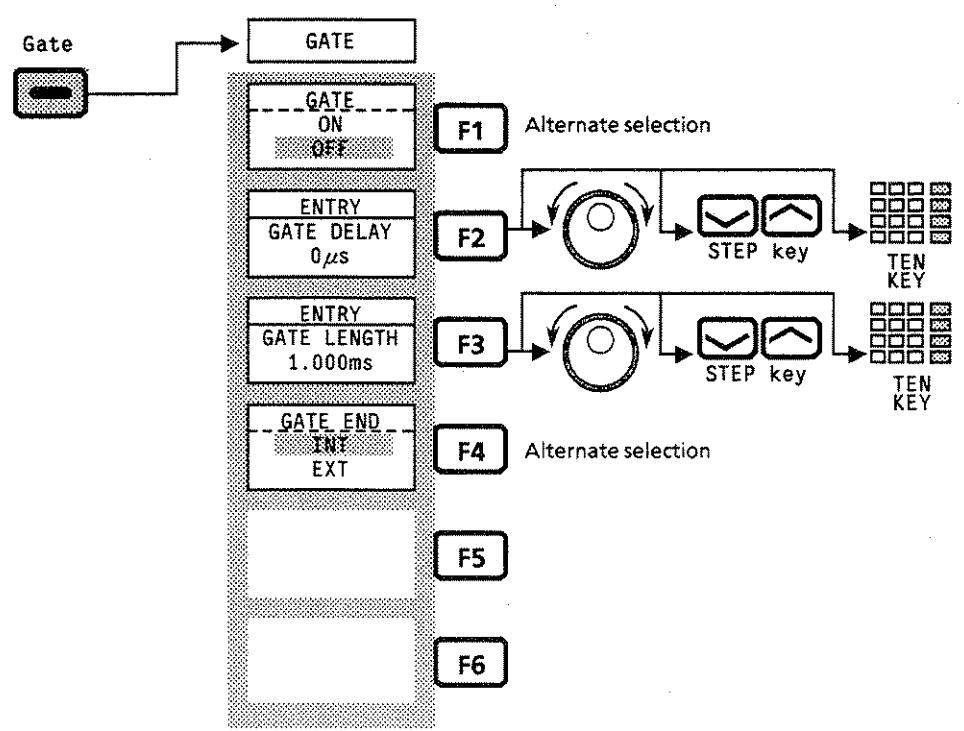
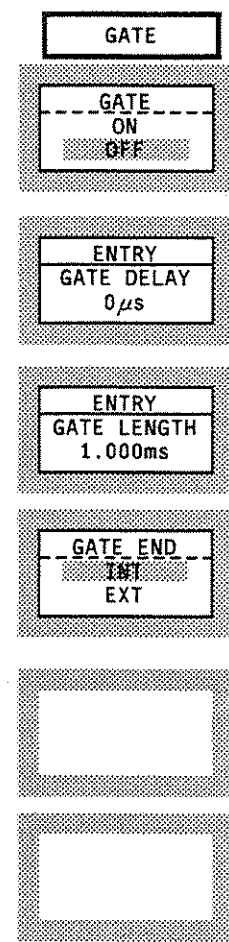

Sets the GPIB port 1 address
Sets the GPIB port 2 address
Sets the MC8104A Data Storage Unit GPIB address
Displays the menu for setting the RS-232C interface (option). ☞ to RS232C
No function
No function

GP-IB
ENTRY PORT1 MY ADDRESS: 1
ENTRY PORT2 MY ADDRESS: 16
ENTRY MC8104A ADDRESS: 19
RS232C * (OPTION 02)

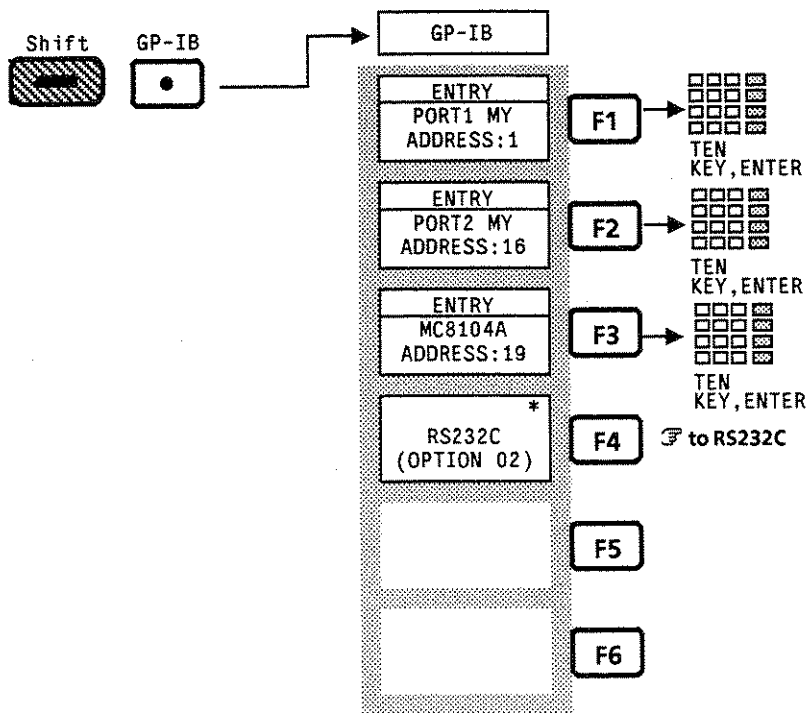

Outputs all items (trace, scale line, and other display items) to the plotter
Outputs the trace only to the plotter
Outputs the scale line to the plotter
No function
No function
Returns to the preceding menu. ↶ to SETUP PLTR

ITEM
ALL
TRACE
SCALE
RETURN

Shift Copy Cont
 Copy

COPY CONT	
DEVICE PRINTER PLOTTER	F1
SETUP PRINTER *	F2
SETUP PLOTTER *	F3
PRESET PLOT LOCATION	F4
	F5
	F6

SETUP PLTR	
PLOTTER HP-GL GRAPH	F1
PAPER SIZE *	F2
LOCATION *	F3
ITEM *	F4
ENTRY PLOTTER ADDRESS : 18	F5
RETURN	F6

ITEM	
ALL	F1
TRACE	F2
SCALE	F3
	F4
	F5
RETURN	F6

↶ to SETUP PLTR

Sets the linear scale to 10 % / div
Sets the linear scale to 5 % / div
Sets the linear scale to 2 % / div
Sets the linear scale to 1 % / div
No function
Returns to the preceding menu. ↩ to AMPTD (1 / 2)

LIN SCALE
10%/div
5%/div
2%/div
1%/div
RETURN

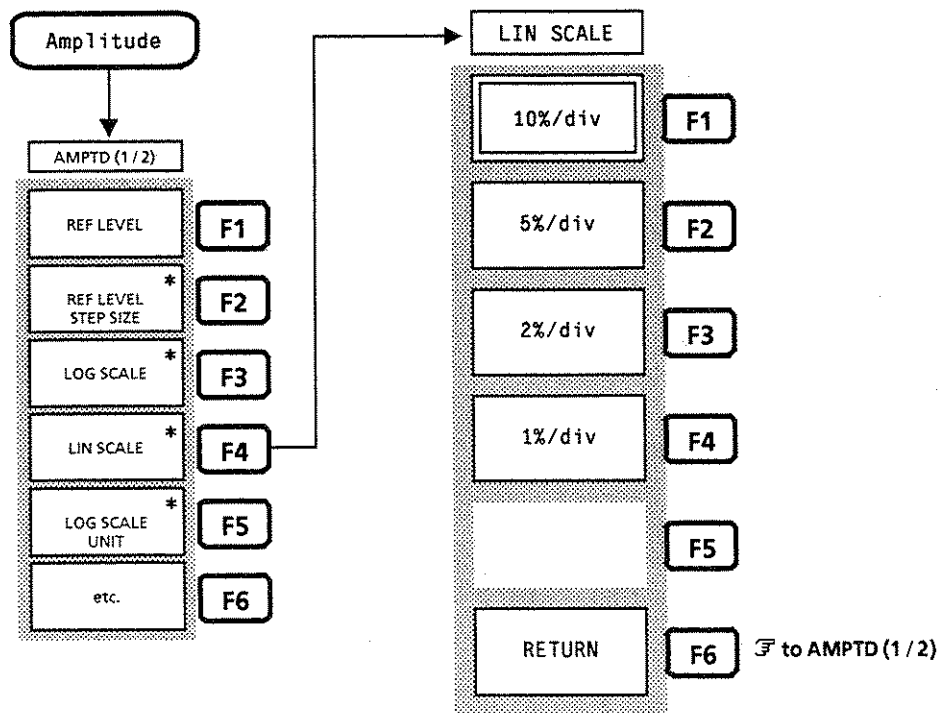

Renews the plotting location automatically
Plots in the upper left-hand corner
Plots in the upper right-hand corner
Plots in the lower left-hand corner
Plots in the lower right-hand corner
Returns to the preceding menu. ⌂ to SETUP PLTR

LOCATION

[1] [2] AUTO
[3] [4]

[#]

[#]

[#]

[#]

RETURN

Shift Copy Cont

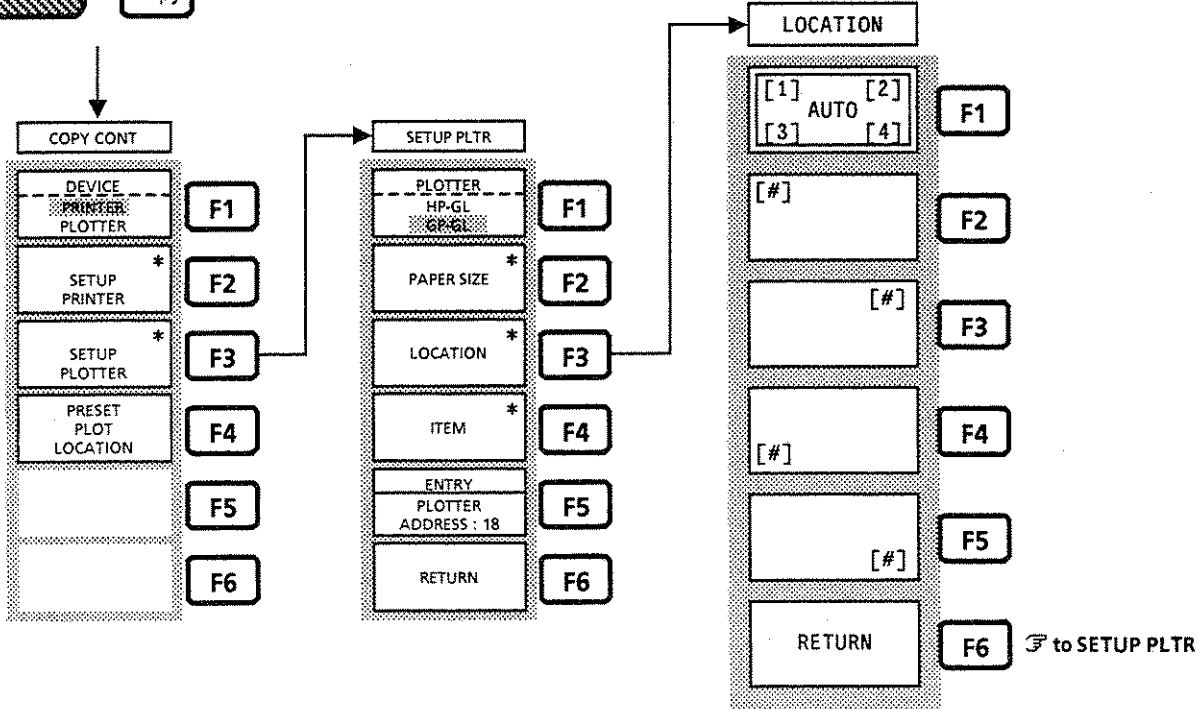

Sets the logarithmic scale to 10 dB / div
Sets the logarithmic scale to 5 dB / div
Sets the logarithmic scale to 2 dB / div
Sets the logarithmic scale to 1 dB / div
No function
Returns to the preceding menu. ↩ to AMPTD (1 / 2)

LOG SCALE
10dB/div
5dB/div
2dB/div
1dB/div
RETURN

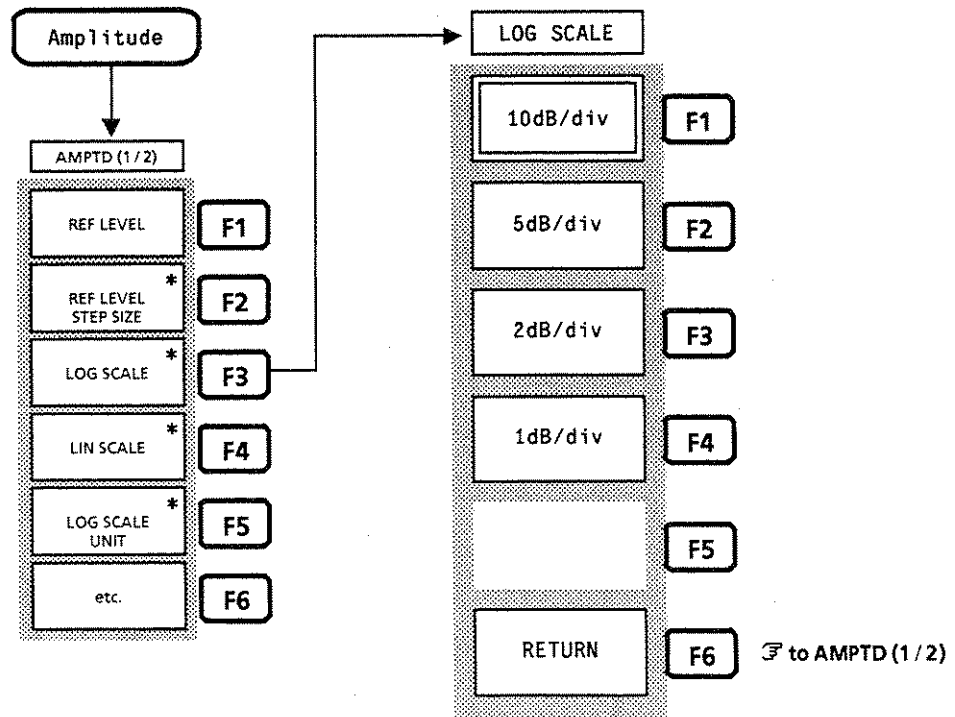

Sets the reference level unit to dBm
Sets the reference level unit to dB μ V
Sets the reference level unit to dBmV
Sets the reference level unit to μ V, mV, or V
Displays the LOG SC UNIT menu on page 2. ↩ to LOG SC UNIT 2
Returns to the preceding menu. ↩ to AMPTD (1 / 2)

LOG SC UNIT1
dBm
dB μ V
dBmV
V
etc.
RETURN

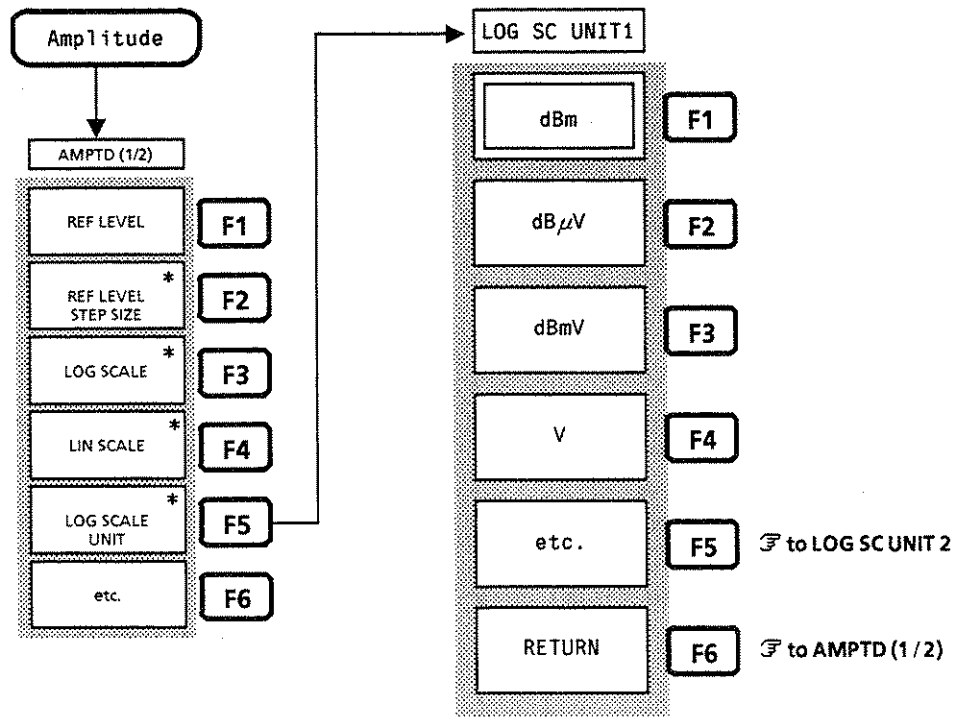

Sets the reference level unit to dBm μ V (emf)	<div style="border: 1px solid black; padding: 2px; text-align: center;">LOG SC UNIT2</div> <div style="border: 1px solid black; padding: 5px; text-align: center;">dBμV(emf)</div>
Sets the reference level unit to W (mW, μ W, pW or fW)	<div style="border: 1px solid black; padding: 5px; text-align: center;">W</div>
No function	<div style="border: 1px solid black; padding: 5px; text-align: center;"> </div>
No function	<div style="border: 1px solid black; padding: 5px; text-align: center;"> </div>
Displays the LOG SC UNIT menu on page 1. ↻ to LOG SC UNIT 1	<div style="border: 1px solid black; padding: 5px; text-align: center;">etc.</div>
Returns to the preceding menu. ↻ to AMPTD (1/2)	<div style="border: 1px solid black; padding: 5px; text-align: center;">RETURN</div>

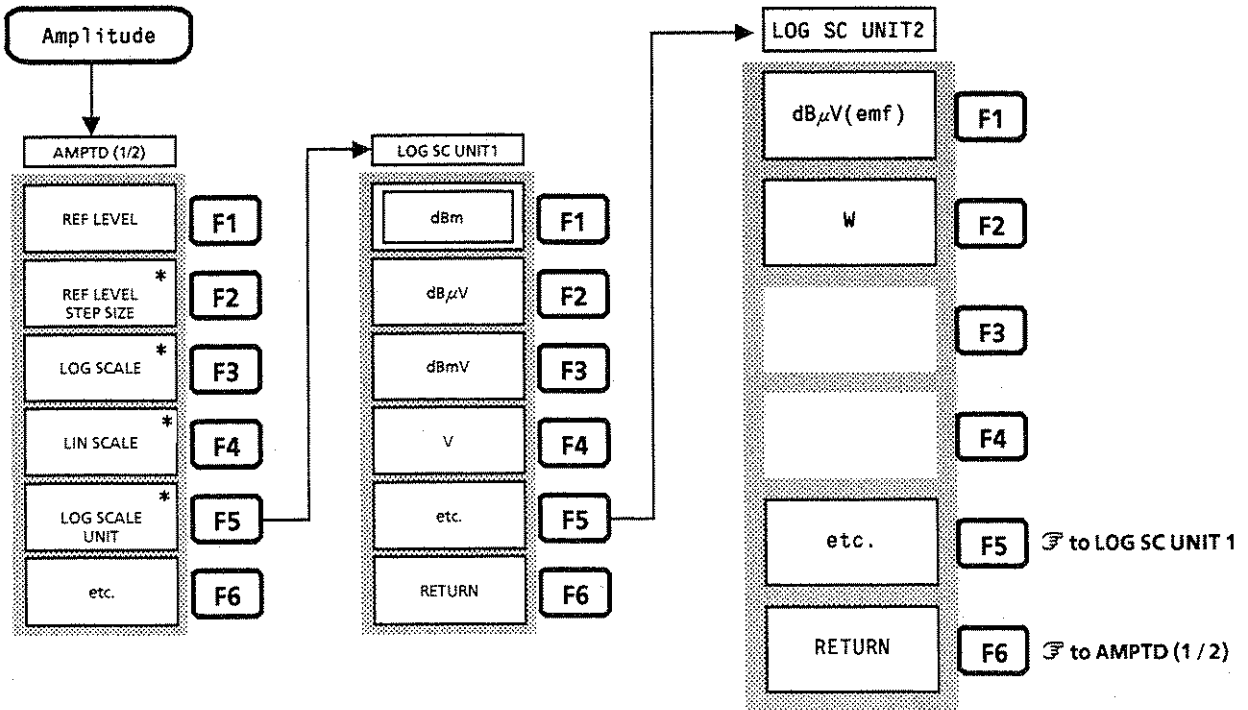

Selects ABS or REL for level measurement
Displays the menu for selecting the limit line to set. F2 to SELECT LINE
Displays the menu for setting the limit line. F3 to DRAW LINE
No function
No function
Returns to the preceding menu. F6 to SETUP TEMP

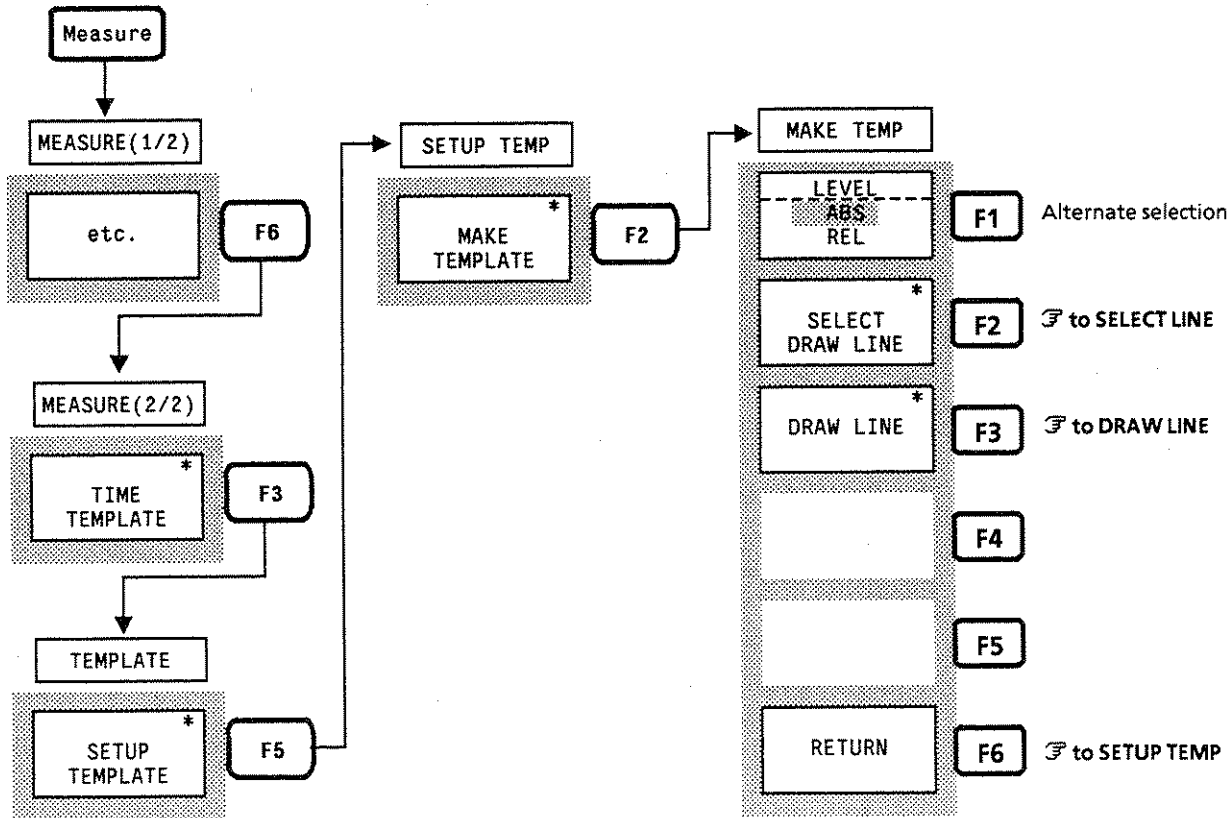
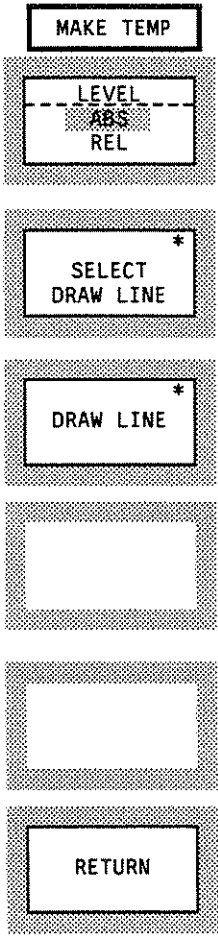

Specifies the marker number to set to ON or OFF. (Each time the [F1] key is pressed, Each of the markers No.1 to No.10 is scrolled for selection.)	MANUAL SET SELECT <NO.1>
Sets the current marker to ON, and makes the selected marker the active marker. (If the selected marker has already been set to ON, the nearest number marker with a larger number is set to ON out of the markers set to OFF.)	ON with AUTO SELECT
Sets the current marker to OFF. (If the selected marker has already been set to OFF, the nearest number marker with smaller number is set to OFF out of the markers set to ON. When active marker is set to OFF, the ON marker with next smaller number is made the active marker.)	OFF with AUTO SELECT
Selects an active marker out of the markers currently set to ON. (Each time this key is pressed, the marker number set to ON out of the markers No. 1 to No. 10 is scrolled for selection.)	ACTIVE MARKER
Leaves only the marker number currently the active marker, and sets all other multimarkers to OFF. (Then, the active marker number is returned to 1.)	CLEAR
Returns to the preceding menu. ↻ to MULTI MKR	RETURN

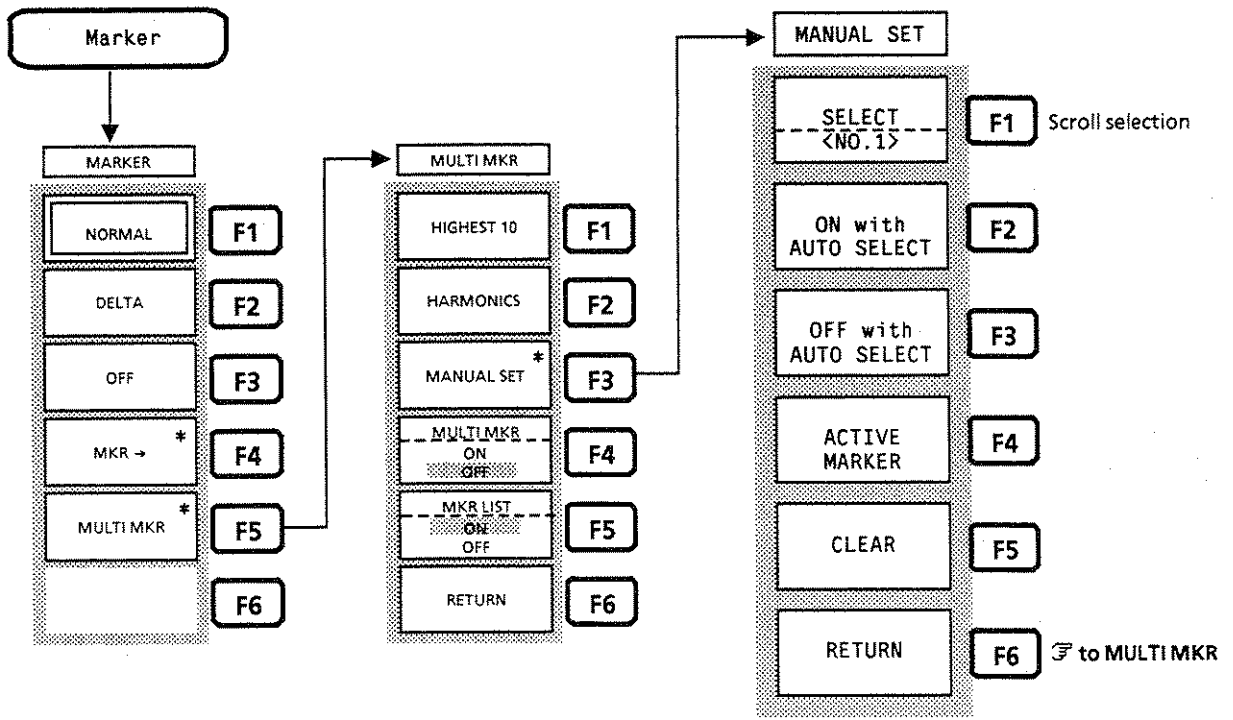

Sets the marker mode to normal marker
Sets the marker mode to delta marker
Sets all markers to OFF
Displays the parameter menu for setting the marker value. F to MKR →
Displays the menu for setting the marker function by which up to ten markers can be displayed simultaneously. F to MULTI MKR
No function

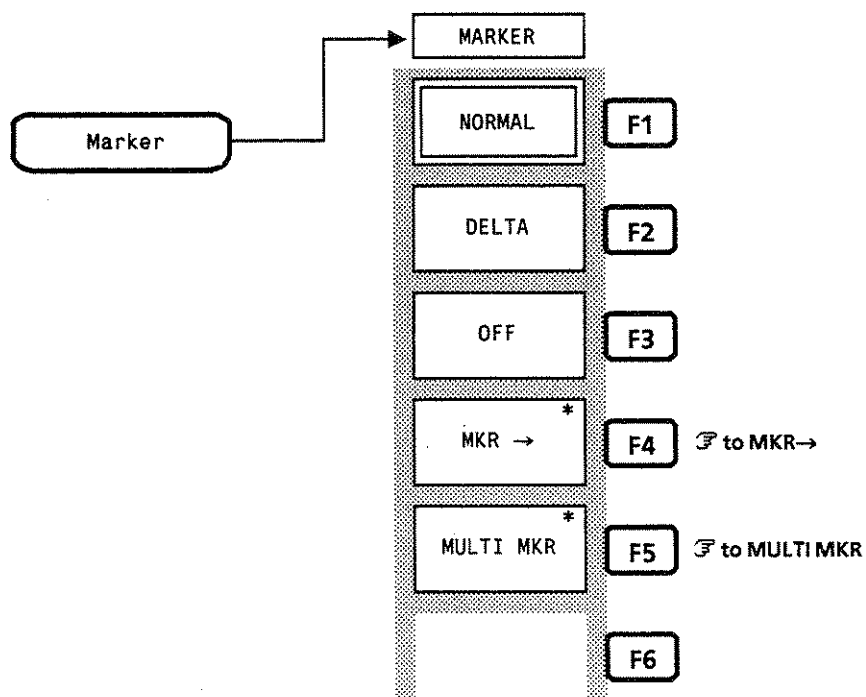
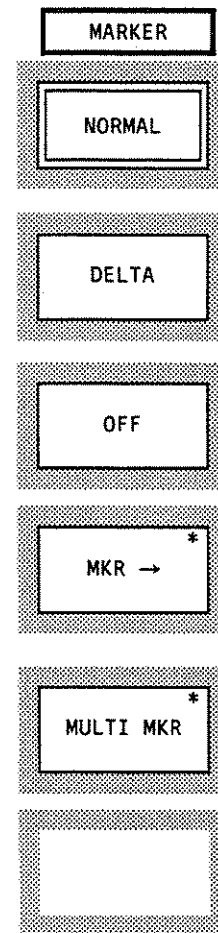

<p>Sets the trace A storage mode to MAX HOLD. MAX HOLD: At each sweep, compares new trace data with previous data at a point on each X axis, then displays the larger value.</p>	<p>MAX/MIN/AVG</p> <p>MAX HOLD</p>
<p>Sets the trace A storage mode to MIN HOLD. MIN HOLD: At each sweep, compares new trace data with previous data at a point on each X axis, then displays the smaller value.</p>	<p>MIN HOLD</p>
<p>Sets the trace A storage mode to AVERAGE. AVERAGE: At each sweep, calculates the average data at a point on each X axis, then displays the average results. This mode is used to improve S/N.</p>	<p>AVERAGE</p>
<p>Sets the averaging rate in trace A</p>	<p>ENTRY AVERAGE 8</p>
<p>No function</p>	<p></p>
<p>Returns to the preceding menu. ↩ to TRACE-A</p>	<p>RETURN</p>

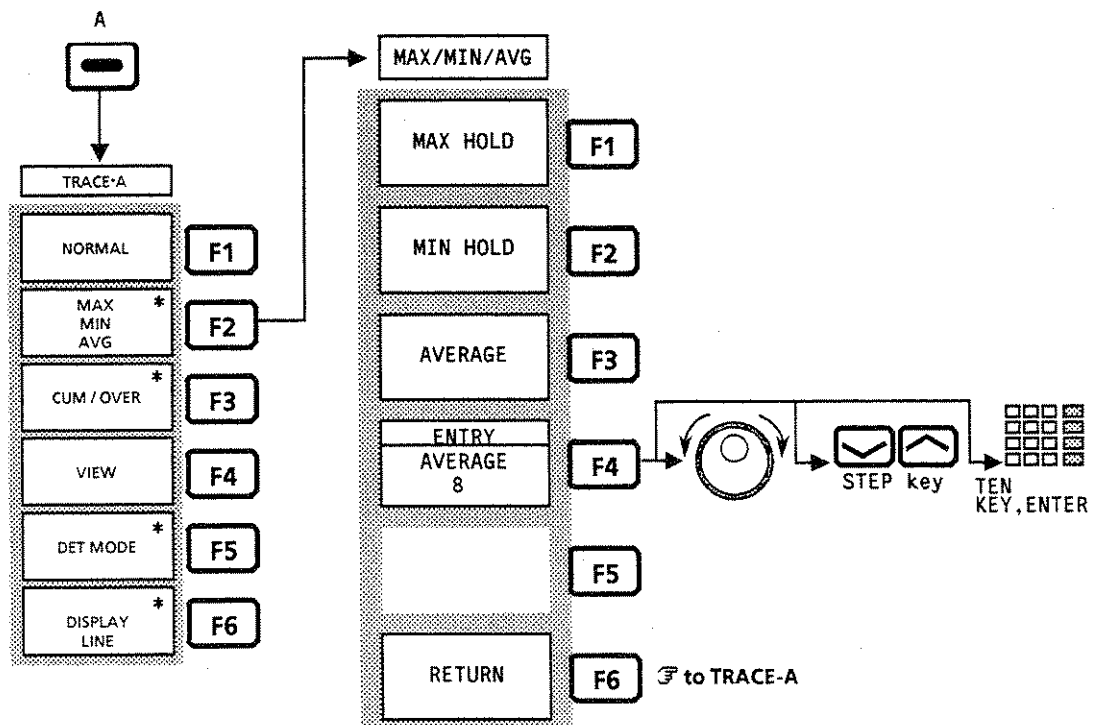

<p>Sets the trace B storage mode to MAX HOLD. MAX HOLD: At each sweep, compares new trace data with previous data at a point on each X axis, then displays the larger value.</p>
<p>Sets the trace B storage mode to MIN HOLD. MIN HOLD: At each sweep, compares new trace data with previous data at a point on each X axis, then displays the smaller value.</p>
<p>Sets the trace B storage mode to AVERAGE. AVERAGE: At each sweep, calculates the average data at a point on each X axis, then displays the average results. This mode is used to improve S / N.</p>
<p>Sets the averaging rate in trace B</p>
<p>No function</p>
<p>Returns to the preceding menu. ↶ to TRACE-B</p>

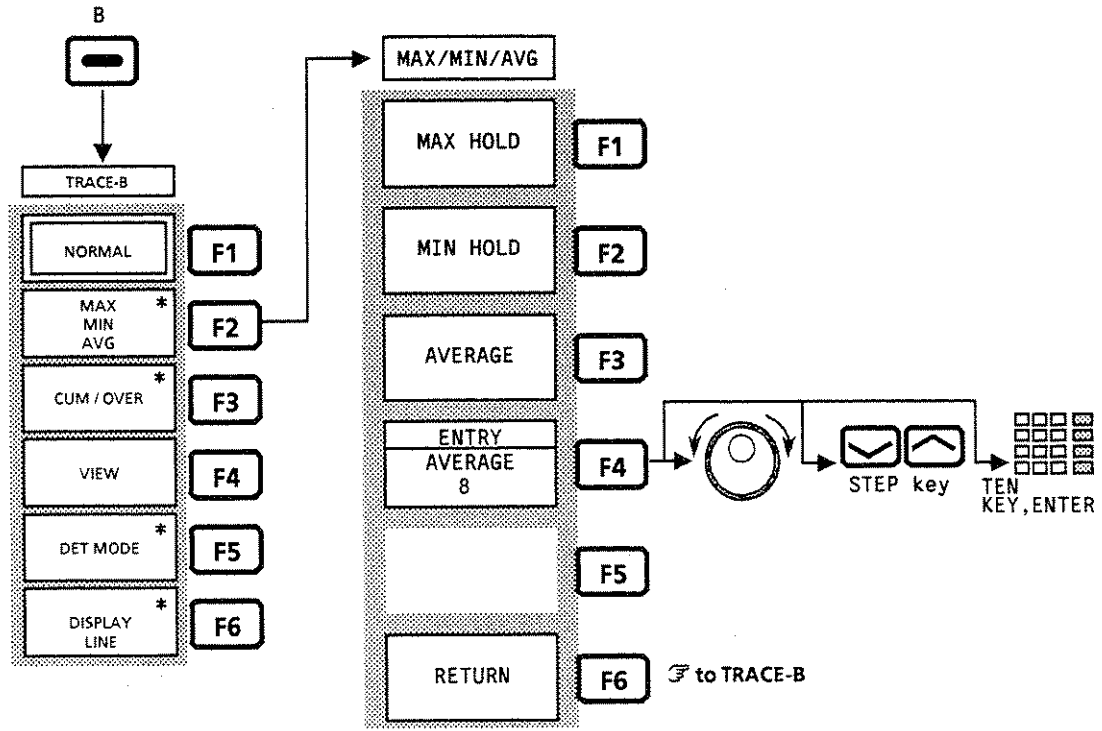
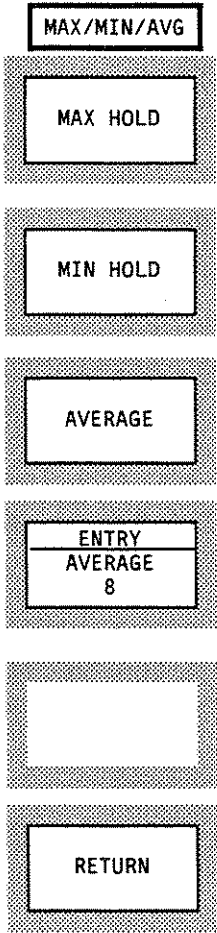

<p>Sets the trace TIME storage mode to MAX HOLD. MAX HOLD: At each sweep, compares new trace data with previous data at a point on each X axis, then displays the larger value.</p>	<div style="border: 1px solid black; padding: 2px; text-align: center;">MAX/MIN/AVG</div> <div style="border: 1px solid black; padding: 5px; text-align: center;">MAX HOLD</div>
<p>Sets the trace TIME storage mode to MIN HOLD. MIN HOLD: At each sweep, compares new trace data with previous data at a point on each X axis, then displays the smaller value.</p>	<div style="border: 1px solid black; padding: 5px; text-align: center;">MIN HOLD</div>
<p>Sets the trace TIME storage mode to AVERAGE. AVERAGE: At each sweep, calculates the average data at a point on each X axis, then displays the average results. This mode is used to improve S / N.</p>	<div style="border: 1px solid black; padding: 5px; text-align: center;">AVERAGE</div>
<p>Sets the averaging rate in trace TIME</p>	<div style="border: 1px solid black; padding: 5px; text-align: center;">ENTRY AVERAGE 8</div>
<p>No function</p>	<div style="border: 1px solid black; padding: 5px; text-align: center;"> </div>
<p>Returns to the preceding menu. ⌂ to STORAGE / DET</p>	<div style="border: 1px solid black; padding: 5px; text-align: center;">RETURN</div>

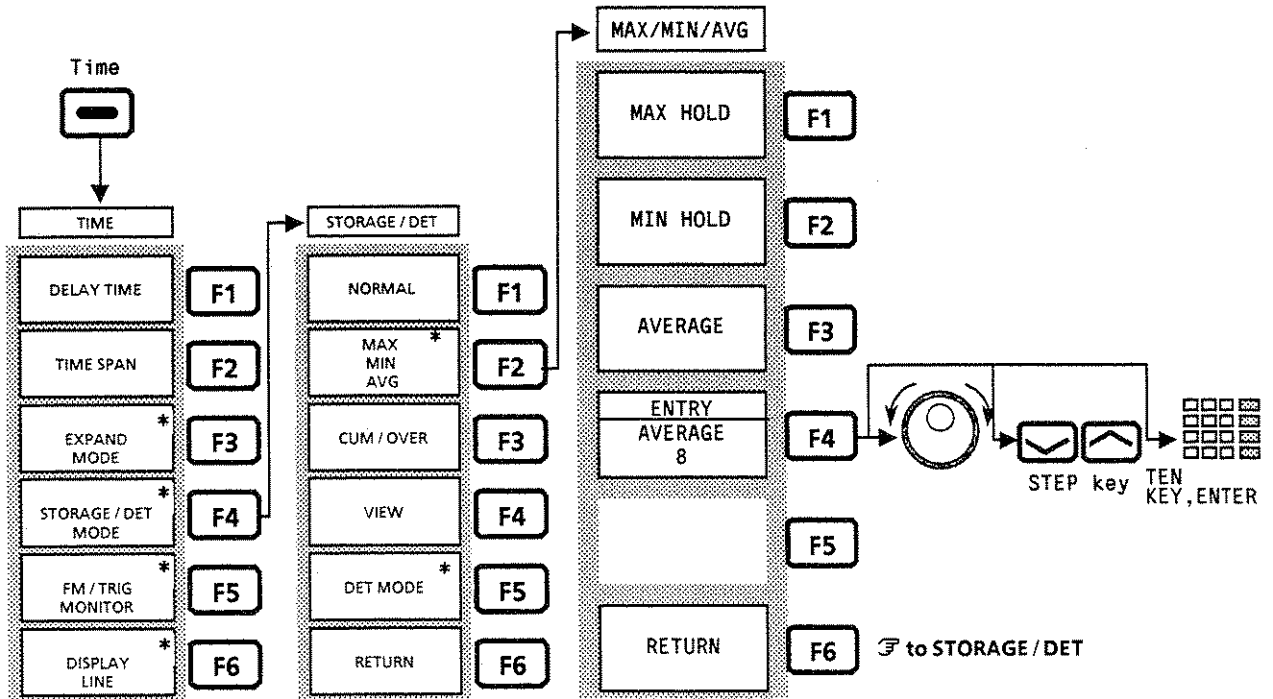

Displays the menu for setting the frequency measurement function. F to FREQ MEAS
Displays the menu for setting the noise measurement function. F to NOISE MEAS
No function
Displays the menu for setting the measure window display position. F to WINDOW POSN
Turns the measurement function OFF
Displays the MEASURE (2 / 2) menu. F to MEASURE (2 / 2)

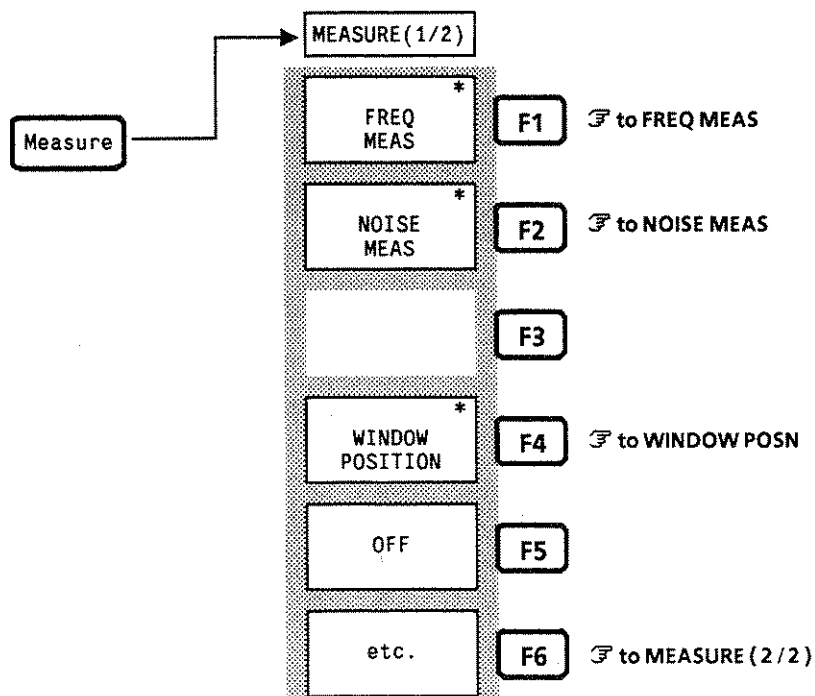
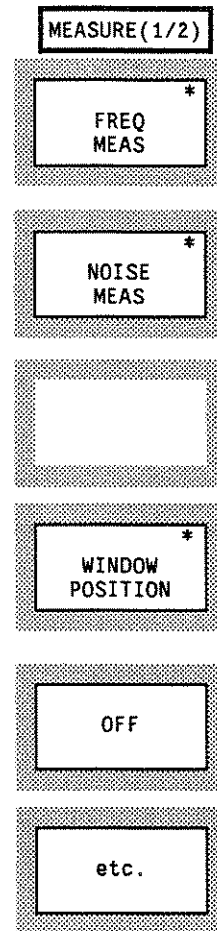

Displays the menu for setting the occupied frequency bandwidth measurement function. F1 to OBW MEAS
Displays the menu for setting the adjacent channel leakage power measurement function. F2 to ADJ CH MEAS
Displays the menu for setting the burst waveform template decision function. F3 to TEMPLATE
Displays the menu for setting the burst average power measurement function. F4 to POWER
Turns the measurement function OFF
Displays the MEASURE (1 / 2) menu. F6 to MEASURE (1 / 2)

MEASURE (2 / 2)

OBW MEAS *

ADJ CH MEAS *

TIME TEMPLATE *

BURST AVG POWER *

OFF

etc.

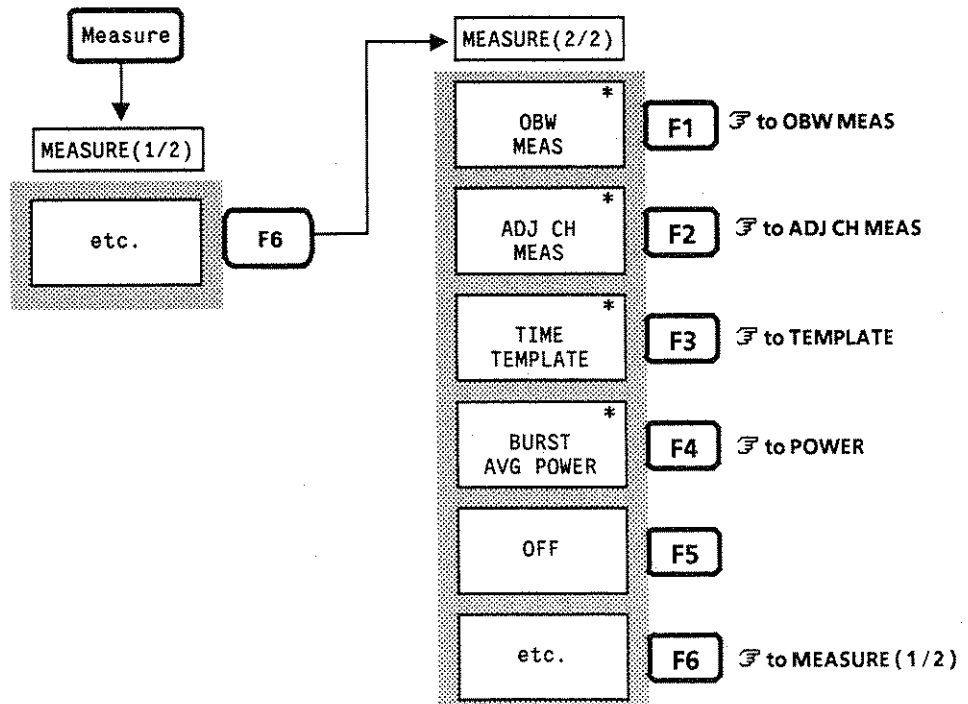

Sets the frequency at the current marker to the center frequency
Sets the level at the current marker to the reference level
Sets the marker frequency to the step size of the center frequency
In delta mode, sets the absolute value of the frequency difference between the delta marker and current marker to the frequency span
Sets the zone width of the zone marker to the frequency span
Returns to the preceding menu. ↶ to MARKER

- MKR→
- MKR→CF
- MKR→REF
- MKR→CF STEP
- ΔMKR→SPAN
- ZONE→SPAN
- RETURN

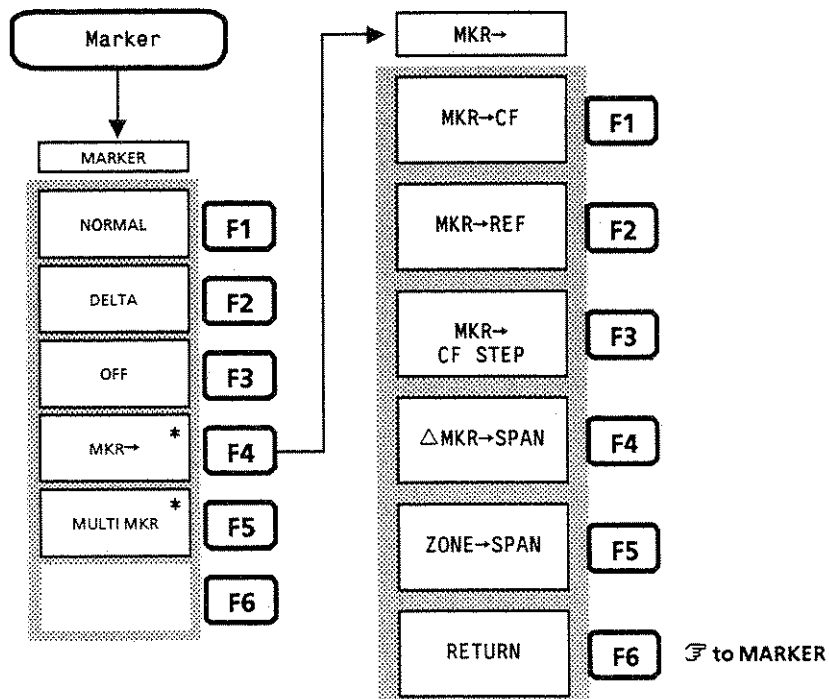

Displays the FM demodulation waveform and the menu for selecting the scale and coupling parameters. ↻ to FM	MONITOR
Displays the external trigger signal waveform	FM MONITOR *
No function	EXT TRIG MONITOR
No function	
Sets the waveform monitoring function to OFF	OFF
Returns to the preceding menu. ↻ to TIME	RETURN

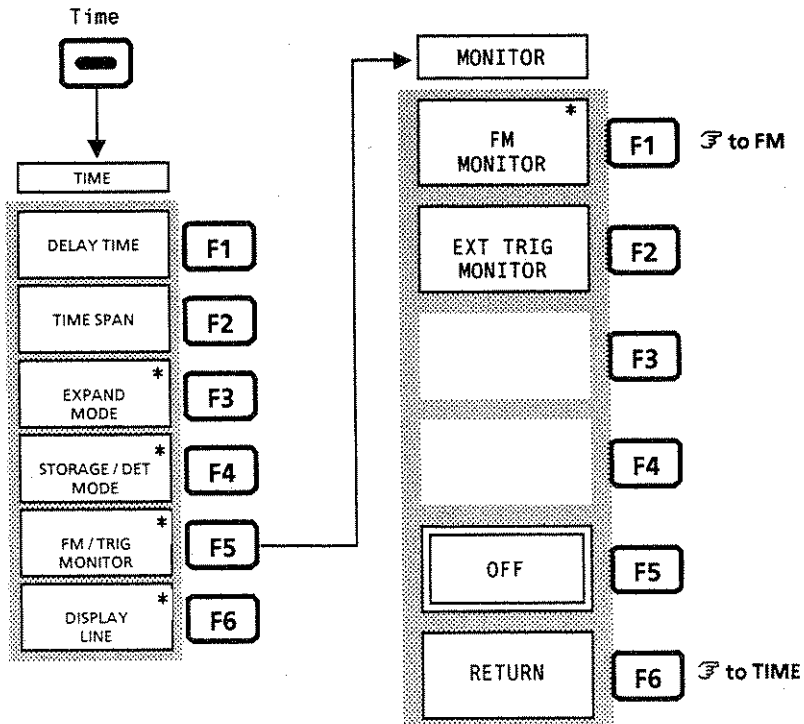

Sets the amount of movement of the template along the X axis
Sets the amount of movement of the template along the Y axis
No function
Activates the moved template
Cancels the movement and returns to the original position
Returns to the preceding menu. ↶ to TEMPLATE

MOVE TEMP

ENTRY
MOVE X
0.0 μ S

ENTRY
MOVE Y
0.00dB

UPDATE

CANCEL

RETURN

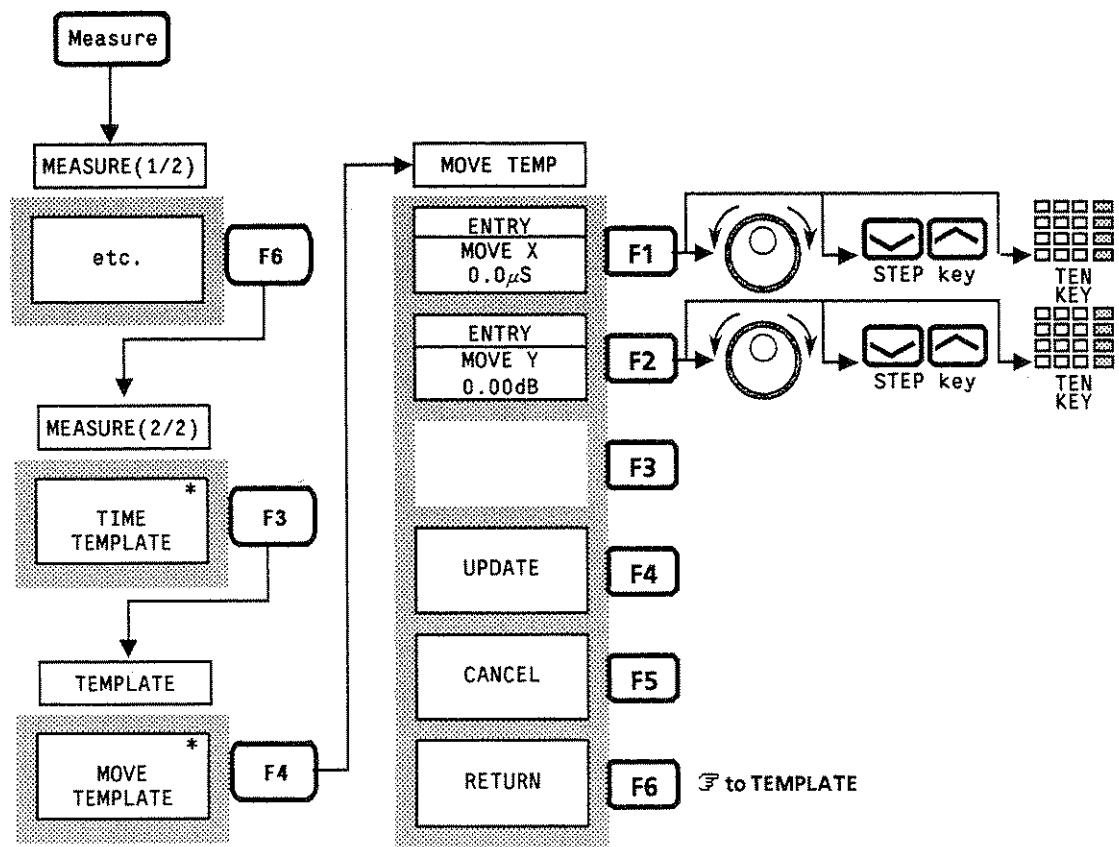

MOVE TEMP

Allocates up to ten multimarkers in descending order of the signal peak level displayed on the screen
Allocates multimarkers to the harmonic signal associated with the signal shown by the current marker
Displays the menu for allocating up to ten multimarkers to arbitrary frequencies or time points. ↻ to MANUAL SET
Sets the multimarker to ON/OFF
Sets the frequency and level list display of all multimarkers to ON or OFF
Returns to the preceding menu. ↻ to MARKER

MULTI MKR

HIGHEST 10

HARMONICS

MANUAL SET *

MULTI MKR
ON
OFF

MKR LIST
ON
OFF

RETURN

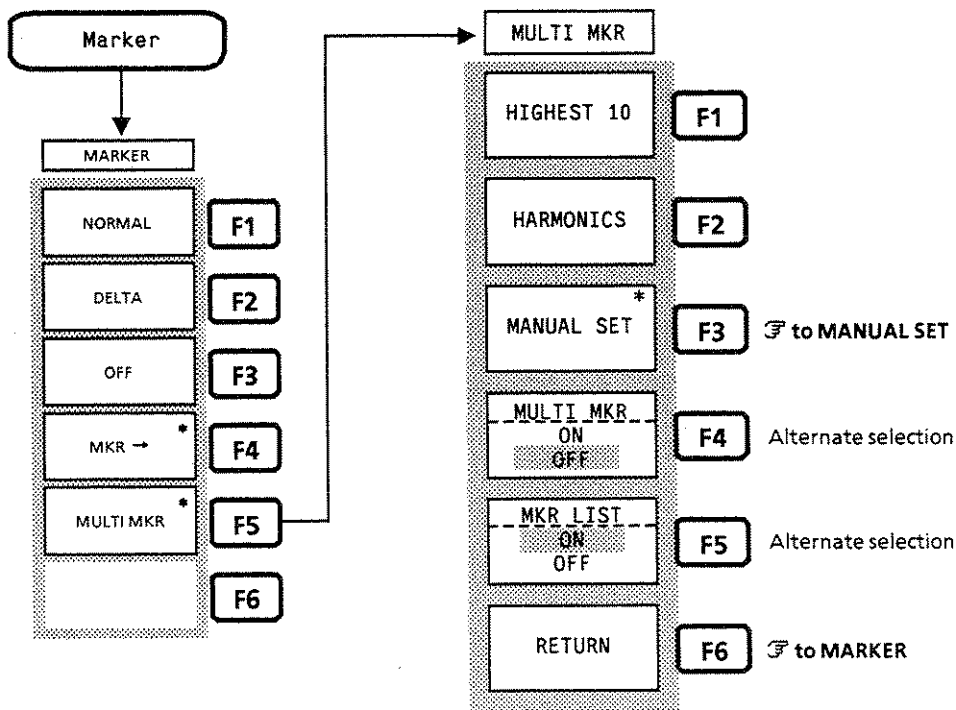

Turns the noise measurement function ON	<div style="border: 1px solid black; padding: 2px; text-align: center;">NOISE MEAS</div> <div style="border: 1px solid black; padding: 5px; text-align: center; margin-top: 5px;">ON</div>
No function	<div style="border: 1px solid black; padding: 5px; text-align: center;"> </div>
No function	<div style="border: 1px solid black; padding: 5px; text-align: center;"> </div>
Turns the noise measurement function OFF	<div style="border: 1px solid black; padding: 5px; text-align: center; margin-top: 5px;">OFF</div>
Selects the noise level or C/N measurement	<div style="border: 1px solid black; padding: 5px; text-align: center; margin-top: 5px;"> NOISE ABSOLUTE C/N RATIO </div>
Returns to the preceding menu. ↩ to MEASURE (1/2)	<div style="border: 1px solid black; padding: 5px; text-align: center; margin-top: 5px;">RETURN</div>

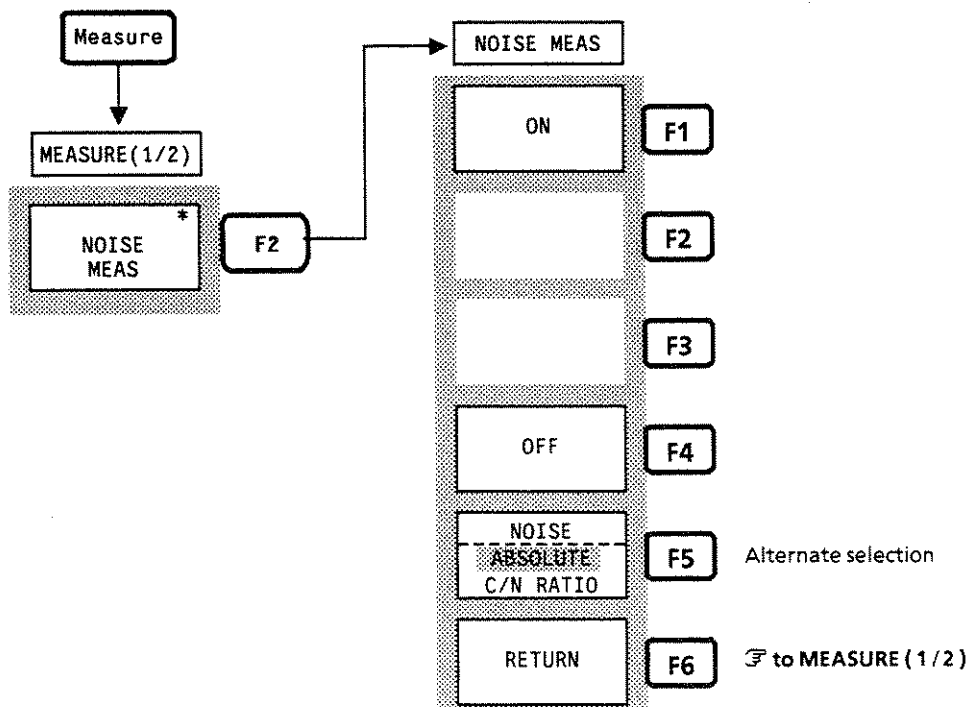

Measures the occupied frequency bandwidth	<div style="border: 1px solid black; padding: 2px; text-align: center;">OBW MEAS</div> <div style="border: 1px solid black; padding: 2px; text-align: center; margin-top: 5px;">EXECUTE</div>
No function	<div style="border: 1px solid black; height: 70px; width: 100%;"></div>
No function	<div style="border: 1px solid black; height: 70px; width: 100%;"></div>
No function	<div style="border: 1px solid black; height: 70px; width: 100%;"></div>
Displays the menu for setting the occupied frequency bandwidth measurement conditions. ⌂ to SETUP	<div style="border: 1px solid black; padding: 2px; text-align: center; margin-top: 5px;">SETUP *</div>
Returns to the preceding menu. ⌂ to MEASURE (2/2)	<div style="border: 1px solid black; padding: 2px; text-align: center; margin-top: 5px;">RETURN</div>

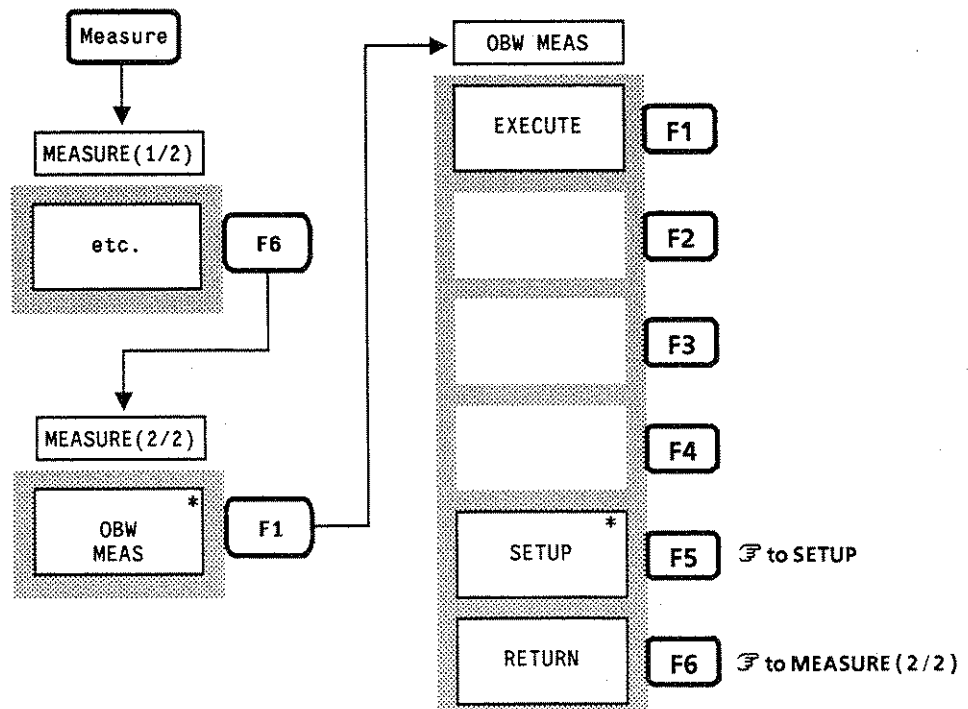

Selects A4 or A3 as the size of the paper output from the plotter
Plots over the whole paper area
Plots over a quarter of the paper area
No function
No function
Returns to the preceding menu. ⇐ to SETUP PLTR

PAPER SIZE

PAPER SIZE
A4
A3

FULL SIZE

QUARTER SIZE

RETURN

Shift Copy Cont

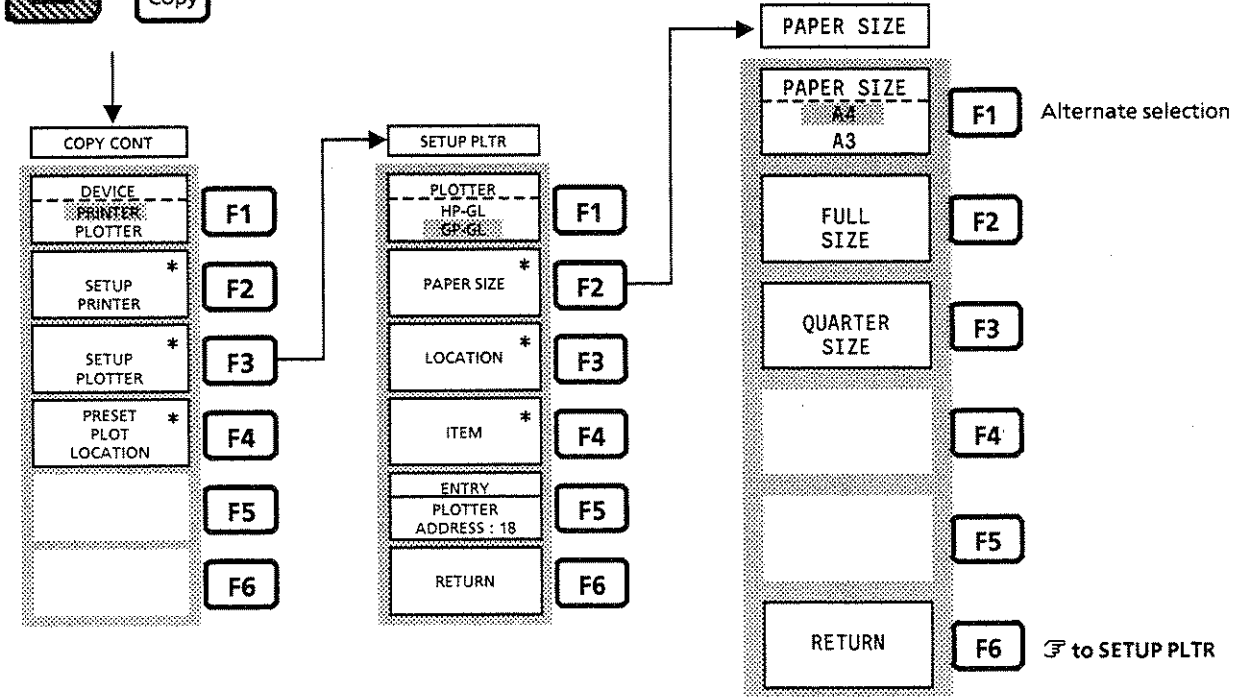

Adds 1 bit for even parity to RS-232C transfer data	PARITY
	EVEN
Adds 1 bit for odd parity to RS-232C transfer data	ODD
Does not add a parity bit to RS-232C transfer data	OFF
No function	
No function	
Returns to the preceding menu. ↩ to RS232C	RETURN

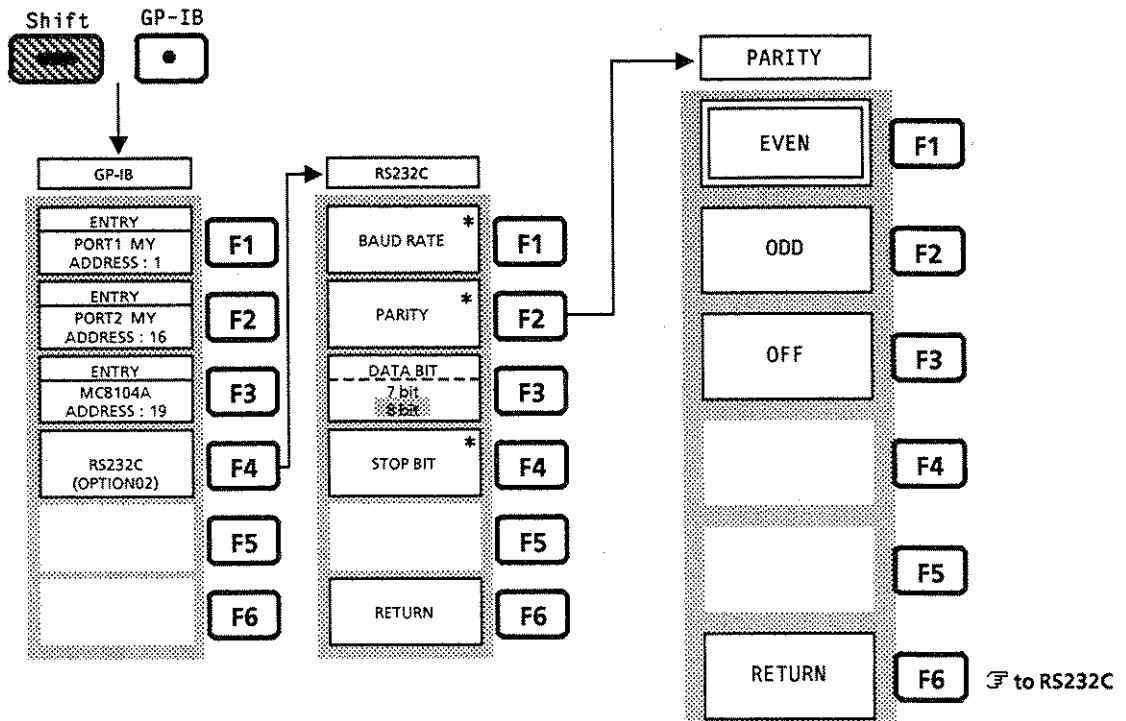

Sets the frequency at the current marker to the center frequency
Detects the next largest peak relative to the current marker level and moves the marker to that point
Detects the peak level adjacent to the right of the current marker level and moves the marker to that point
Detects the peak level adjacent to the left of the current marker level and moves the marker to that point
From the entire trace in which a marker is displayed, detects the minimum level point and moves the marker to that point
Detects the next smallest dip relative to the current marker level and moves the marker to that point

- PEAK SEARCH
- MKR→CF
- NEXT PEAK
- NEXT RIGHT PEAK
- NEXT LEFT PEAK
- MIN DIP
- NEXT DIP

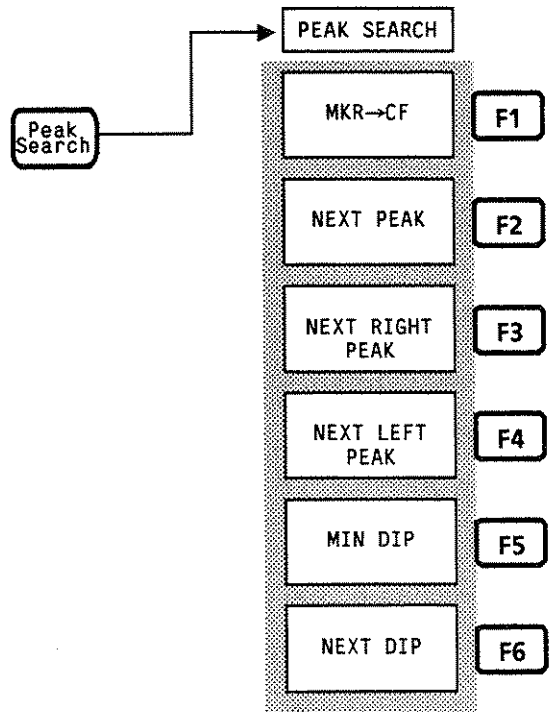

Displays the data for the file directory. F to DIRECTORY	PMC DIRECTORY *
Displays the APPLY key for formatting the PMC. F to FORMAT	FORMAT *
No function	
No function	
No function	
Displays the menu for selecting the media. F to SELECT MEDIA	SELECT MEDIA *

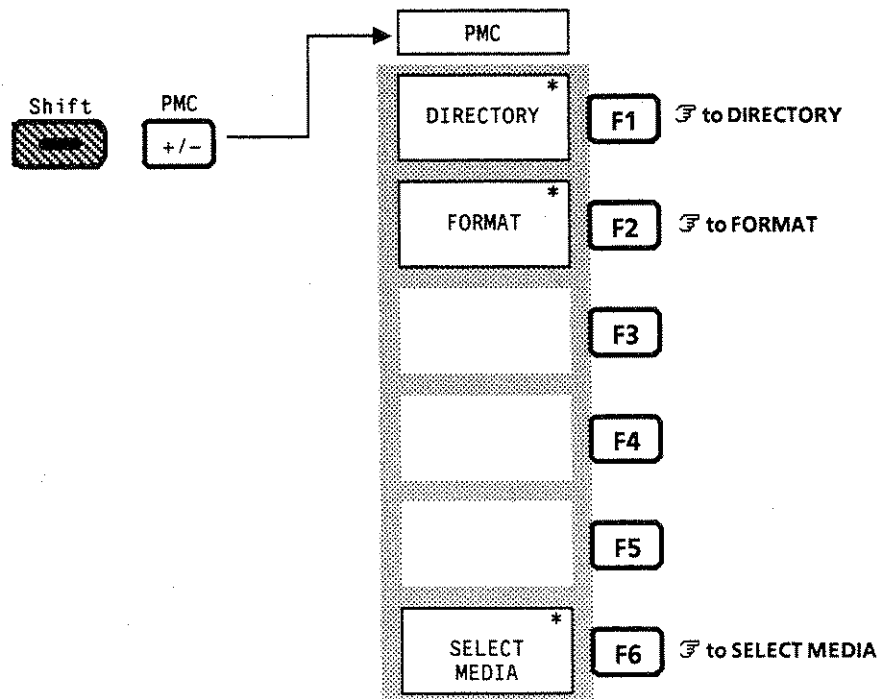

Recalls the specified file
Displays the directory of PMC or floppy disk
No function
No function
Displays the menu for selecting the media. F5 to SELECT MEDIA
Returns to the preceding menu. F6 to RECALL

PMC

FILE No.

DIR/NEXT

SELECT MEDIA *

RETURN

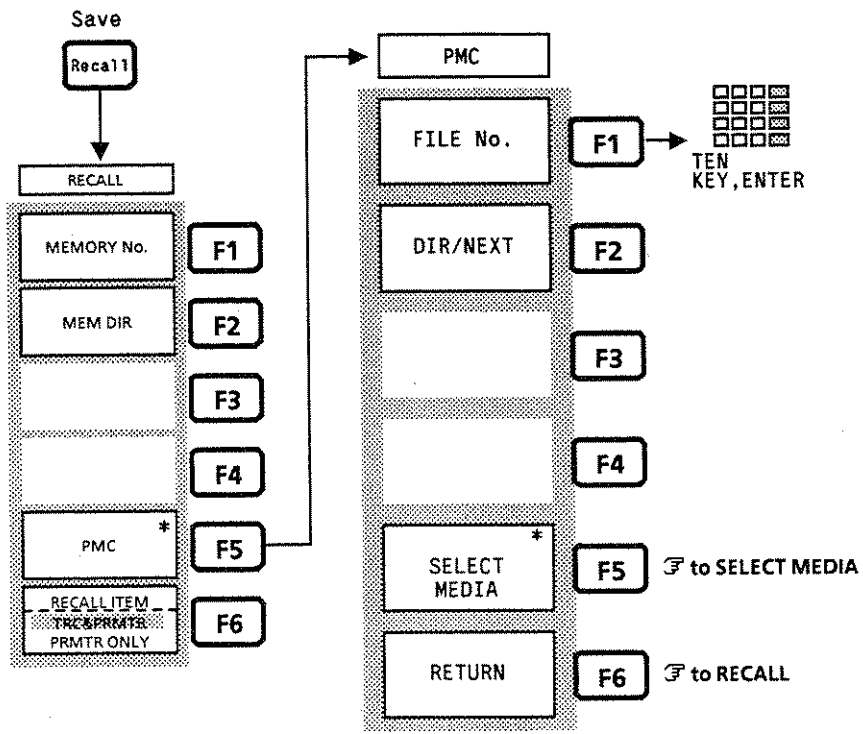

Saves the specified file to memory
Displays the directory of PMC or floppy disk
Deletes the specified file
Write-protects (write-inhibit) the specified file
Displays the menu for selecting the media. ⇧ to SELECT MEDIA
Returns to the preceding menu. ⇧ to SAVE

PMC
SAVE FILE No.
DIR/NEXT
DELETE FILE No.
WRITE PROTECTION FILE No.
SELECT MEDIA *
RETURN

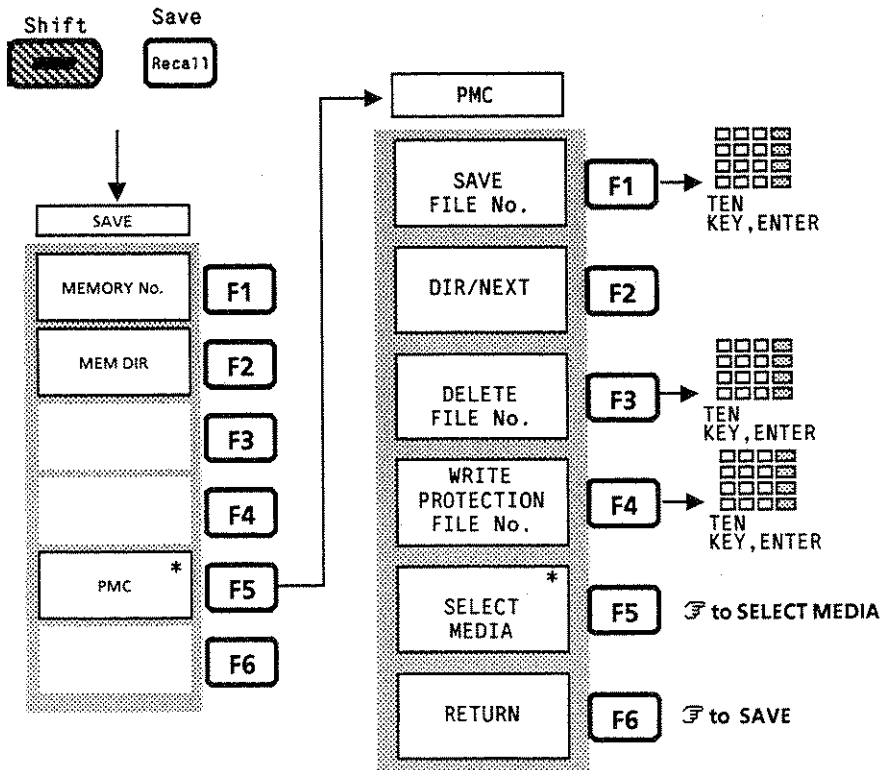

Measures the burst average power
Sets the measurement-starting point (time)
Sets the measurement-ending point (time)
No function
No function
Returns to the preceding menu. ↩ to MEASURE (2/2)

POWER
EXECUTE
ENTRY START POINT
ENTRY STOP POINT
RETURN

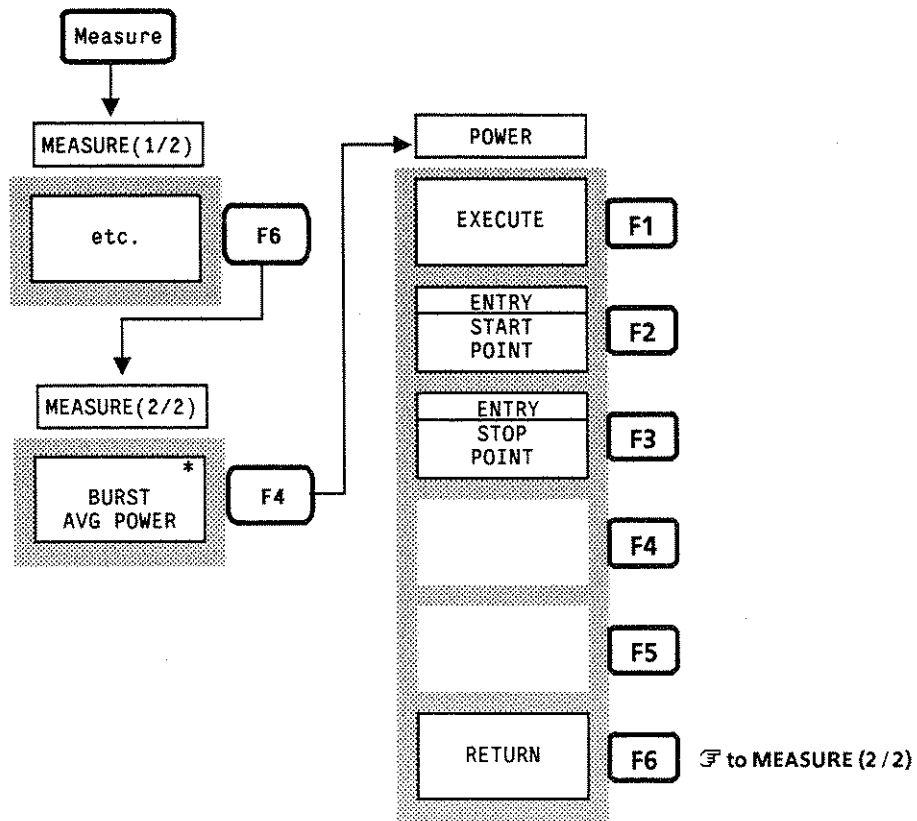

Adjusts the peaking bias automatically
Allows the peaking bias to be set manually
Sets the peaking bias to the initial value (0)
No function
No function
Returns to the preceding menu. ↩ to CAL

PRESEL TUNE

AUTO TUNE

ENTRY MANUAL ****

PRESET

RETURN

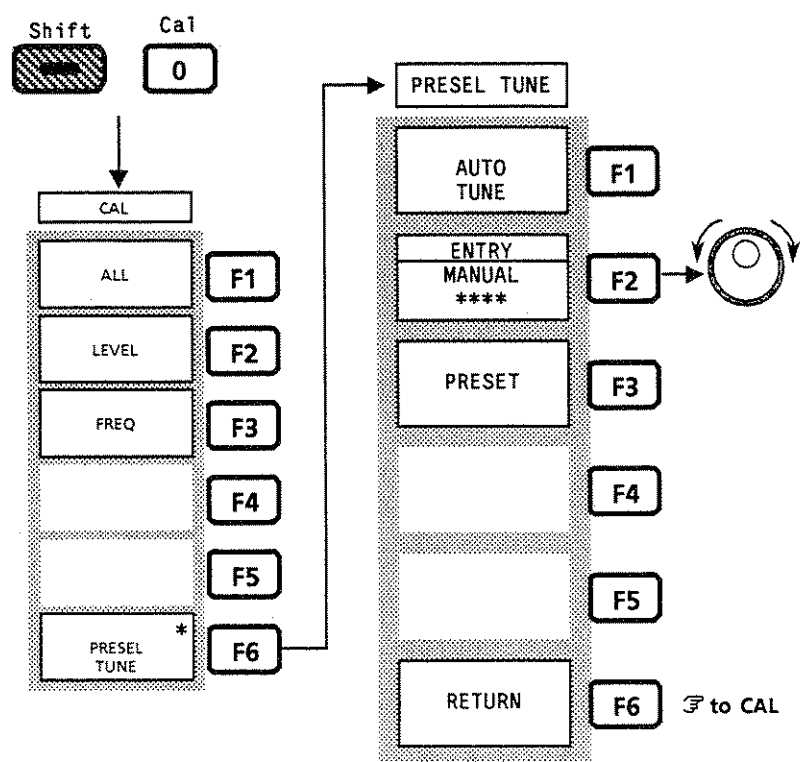

Displays parameter list 1
Displays parameter list 2
Sets the parameter list to OFF
No function
No function
No function

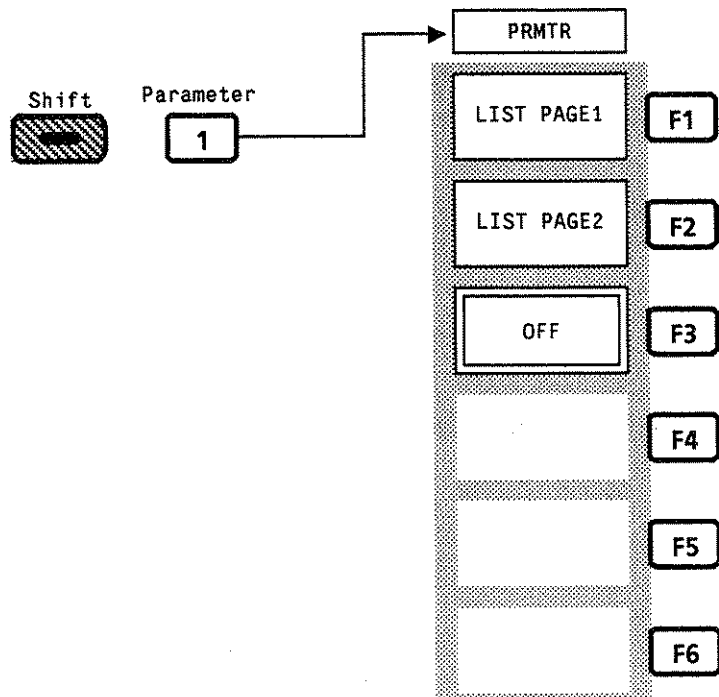
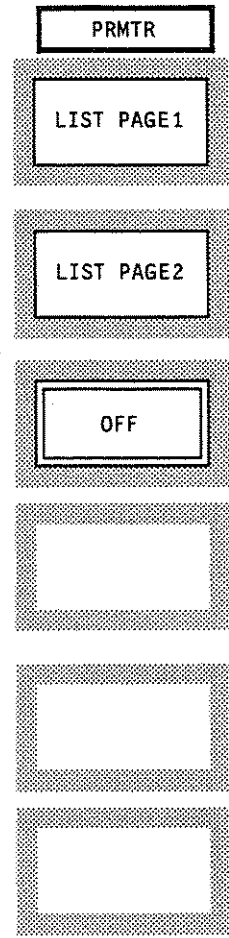

Executes PTA program
Interrupts PTA program execution
Resumes interrupted program
Terminates PTA program execution and initializes user defined variables, etc.
Turns off PTA
Shifts to next PTA menu (PTA(2/4)). ↻ to PTA (2 / 4)

PTA (1/4)

RUN

STOP

CONT

RESET

PTA OFF

etc.

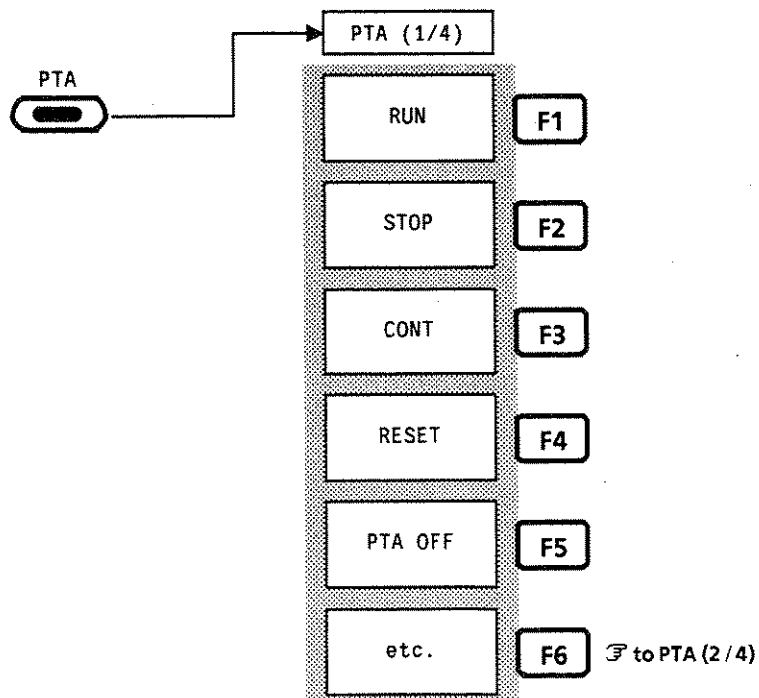

Displays PTA-program file list in PMC or FD media. The media is selected with [F6] (SELECT MEDIA) in PMC menu.
Moves cursor up one line
Moves cursor down one line
Loads program on line specified by cursor. The program file names are displayed by [F1] (PROG LIST) above.
Executes loaded program
Shifts to next PTA menu (PTA(3/4)). ↩ to PTA (3/4)

PTA (2/4)
PROG LIST
CURSOR UP
CURSOR DOWN
LOAD
RUN
etc.

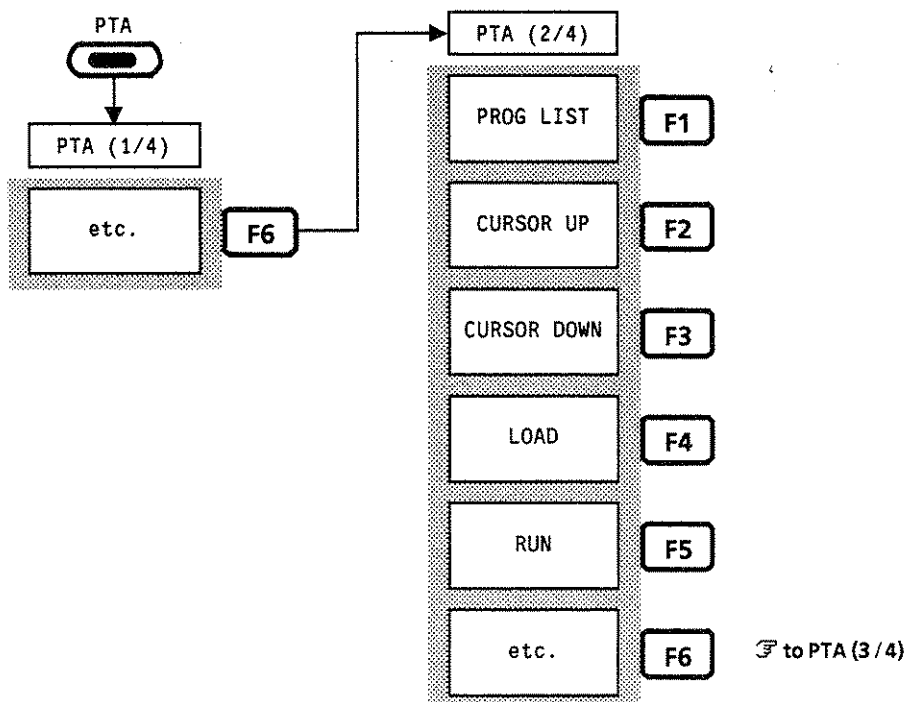

Switches 0/1 state of system variable EX1 used by PTA. Each time this key is pressed, the state changes 0→1→0.	PTA (3/4) F1
Switches 0/1 state of system variable EX2 used by PTA. Each time this key is pressed, the state changes 0→1→0.	F2
Switches 0/1 state of system variable EX3 used by PTA. Each time this key is pressed, the state changes 0→1→0.	F3
Switches 0/1 state of system variable EX4 used by PTA. Each time this key is pressed, the state changes 0→1→0.	F4
Switches 0/1 state of system variable EX5 used by PTA. Each time this key is pressed, the state changes 0→1→0.	F5
Shifts to next PTA menu (PTA(4/4)). ↻ to PTA (4/4)	etc.

[F1] to [F5] and the etc. labels can be freely rewritten by the PTA system subroutine "CALL DEF"

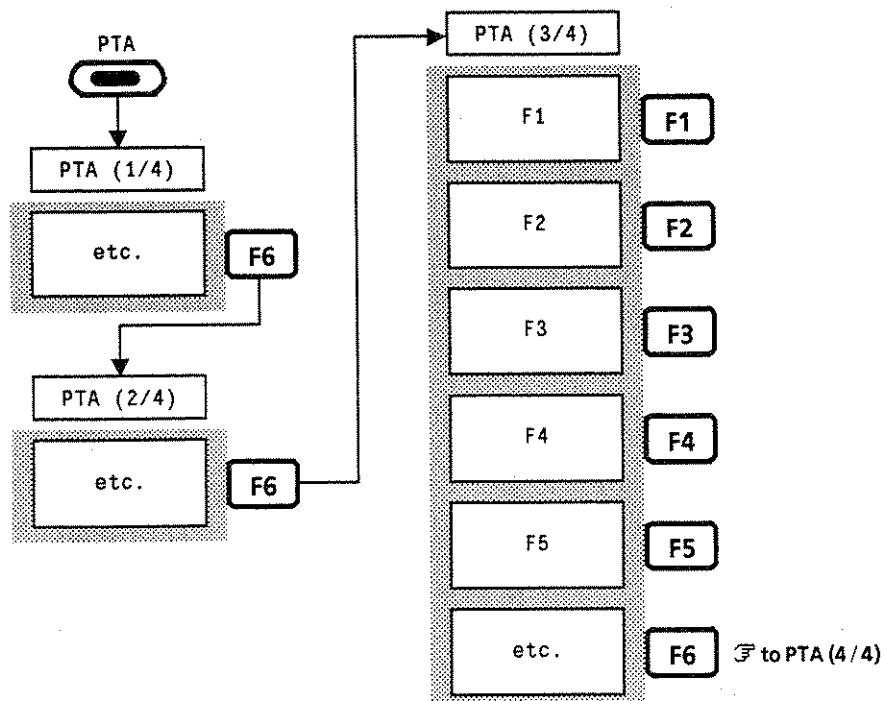

Returns character string "YES" as response to PTA program INPUT statement
Returns character string "NO" as response to PTA program INPUT statement
No function
No function
No function
Returns to initial PTA menu at PTA ON. ↻ to PTA (1/4)

PTA (4/4)
YES
NO
etc.

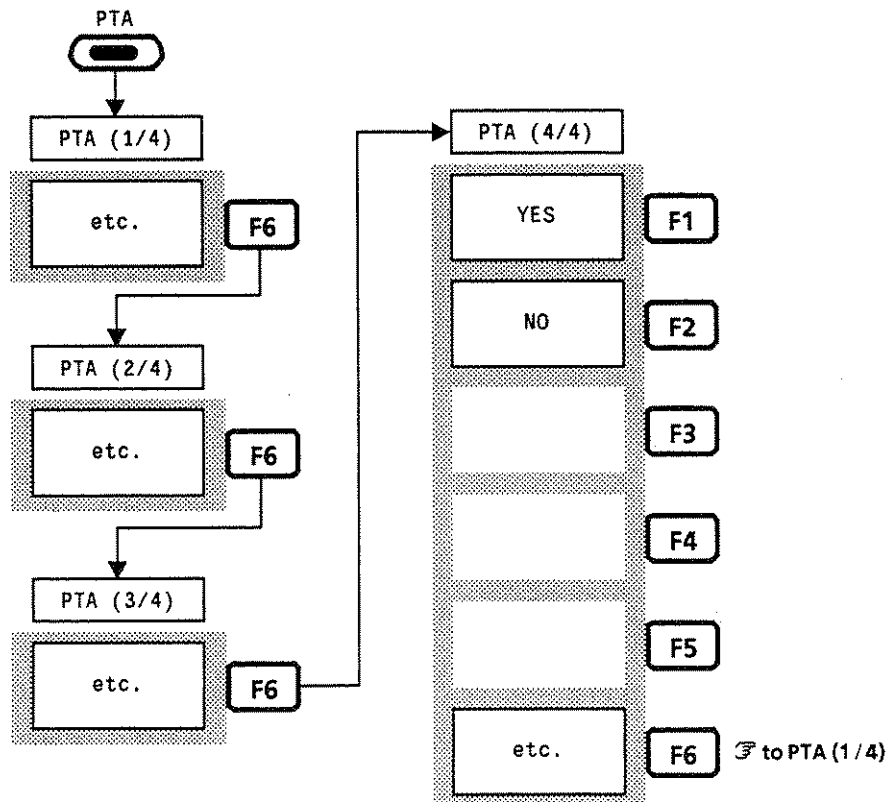

Indicates that the RBW function is set in MANUAL mode. Pressing this key in AUTO mode changes to MANUAL mode.	<div style="border: 1px solid black; padding: 2px; text-align: center;">RBW</div> <div style="border: 1px solid black; padding: 2px; text-align: center;">MANUAL</div>
Indicates that the RBW function is set in AUTO mode. Pressing this key in MANUAL mode changes to AUTO mode.	<div style="border: 1px solid black; padding: 2px; text-align: center;">AUTO</div>
No function	<div style="border: 1px solid black; padding: 2px; text-align: center;"> </div>
No function	<div style="border: 1px solid black; padding: 2px; text-align: center;"> </div>
The manually-set RBW, VBW and Swp Time functions return to AUTO control	<div style="border: 1px solid black; padding: 2px; text-align: center;">RB, VB, SWT AUTO</div>
All the values of the coupled function return to AUTO control	<div style="border: 1px solid black; padding: 2px; text-align: center;">ALL AUTO</div>

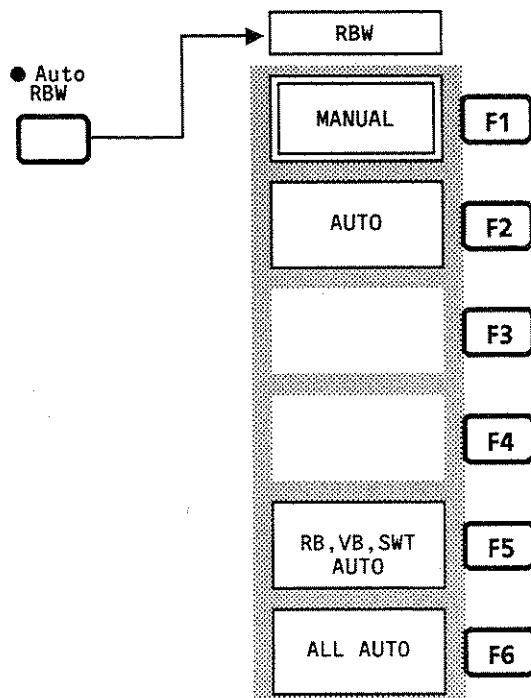

Specifies the memory number for recalling later
Displays the directory of the internal memory
No function
No function
Displays the menu for setting the PMC parameters. F to PMC
Specifies the data contents to recall

RECALL

MEMORY No.

MEM DIR

PMC *

RECALL_ITEM
TRC & PRMTR
RPMTR ONLY

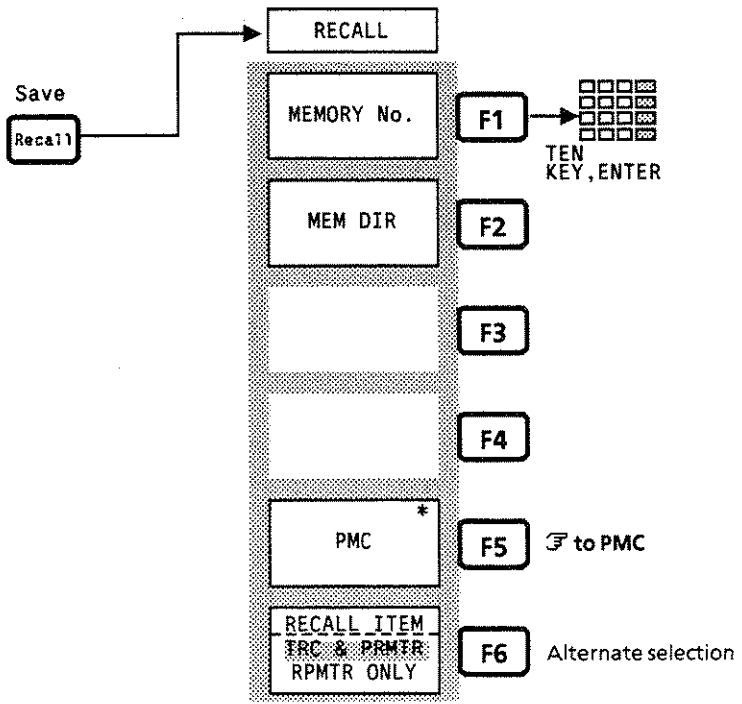

	REF LVL STEP
To set the reference level step size with the [V][^] keys, registers the step size as 1 div	1div
To set the reference level step size with the [V][^] keys, registers the step size as 2 div	2div
To set the reference level step size with the [V][^] keys, registers the step size as 5 div	5div
To set the reference level step size with the [V][^] keys, registers the step size as 10 div	10div
To set the reference level step size with the [V][^] keys, registers the step size with the TEN keys	MANUAL
Returns to the preceding menu. ↩ to AMPTD (1/2)	RETURN

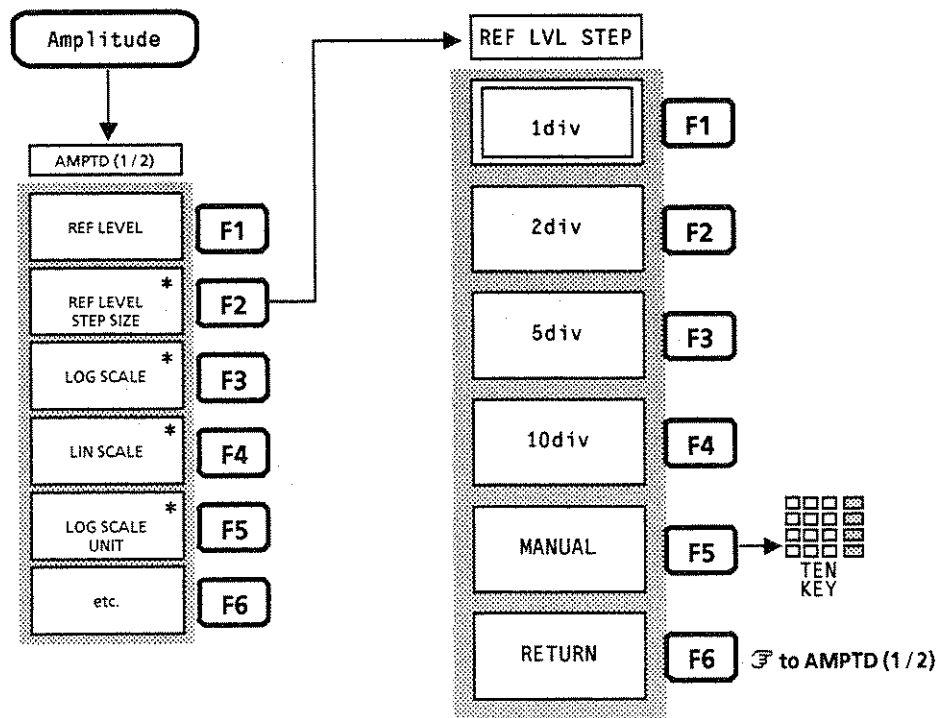

Sets the frequency measurement resolution to 1 kHz
Sets the frequency measurement resolution to 100 Hz
Sets the frequency measurement resolution to 10 Hz
Sets the frequency measurement resolution to 1 Hz
No function
Returns to the preceding menu. ↩ to FREQ MEAS

RESOLUTION
1kHz
100Hz
10Hz
1Hz
RETURN

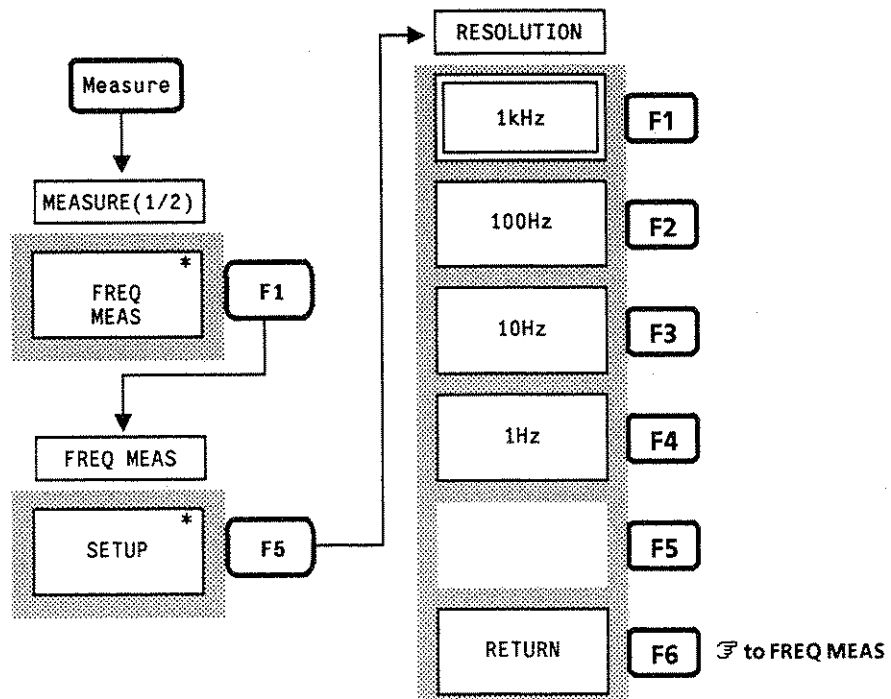

Turns the reference level offset ON or OFF	<div style="border: 1px solid black; padding: 2px; text-align: center;">RLV OFFSET</div> <div style="border: 1px solid black; padding: 2px; text-align: center;">RLV OFFSET ON OFF</div>
Sets the reference level offset	<div style="border: 1px solid black; padding: 2px; text-align: center;">ENTRY OFFSET 0.0dB</div>
No function	<div style="border: 1px solid black; width: 100%; height: 100%;"></div>
No function	<div style="border: 1px solid black; width: 100%; height: 100%;"></div>
No function	<div style="border: 1px solid black; width: 100%; height: 100%;"></div>
Returns to the preceding menu. ↶ to AMPTD (2 / 2)	<div style="border: 1px solid black; padding: 2px; text-align: center;">RETURN</div>

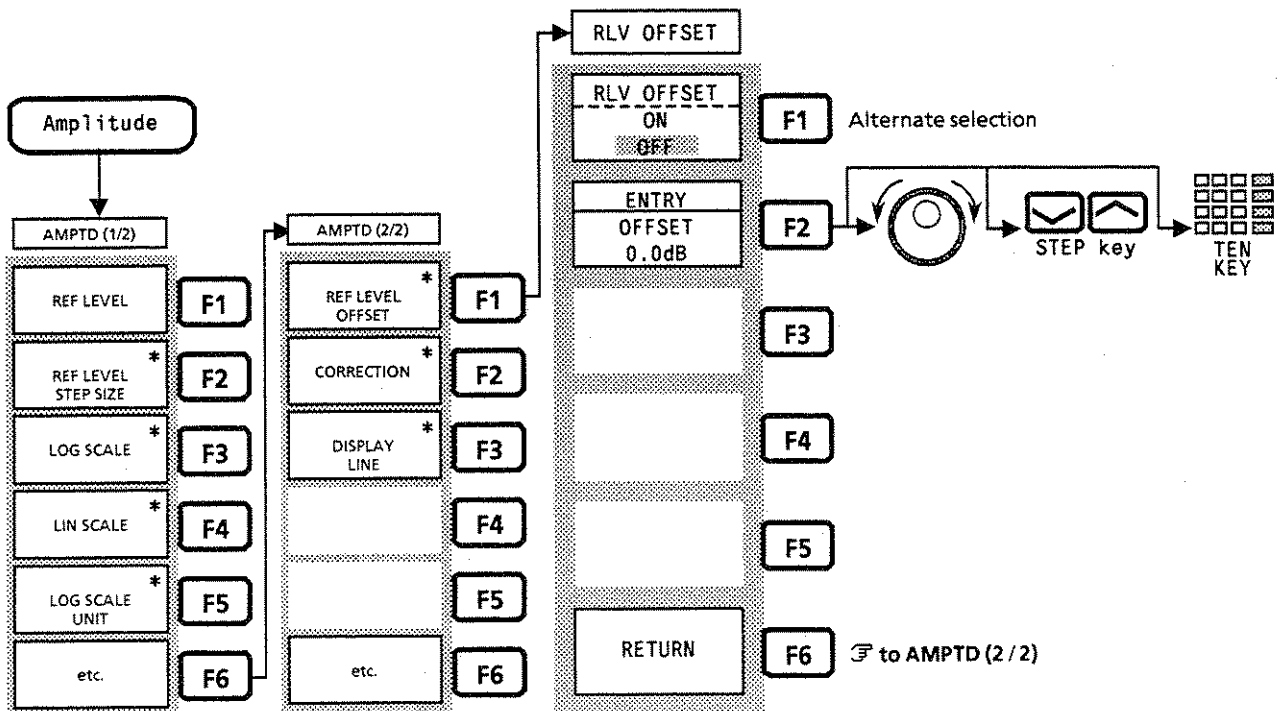

Displays the menu for setting the baud rate. ↻ to BAUD RATE 1
Displays the menu for setting the parity bit. ↻ to PARITY
Selects 7 bit or 8 bit for data bit
Displays the menu for setting the stop bit. ↻ to STOP BIT
No function
Returns to the preceding menu. ↻ to GP-IB

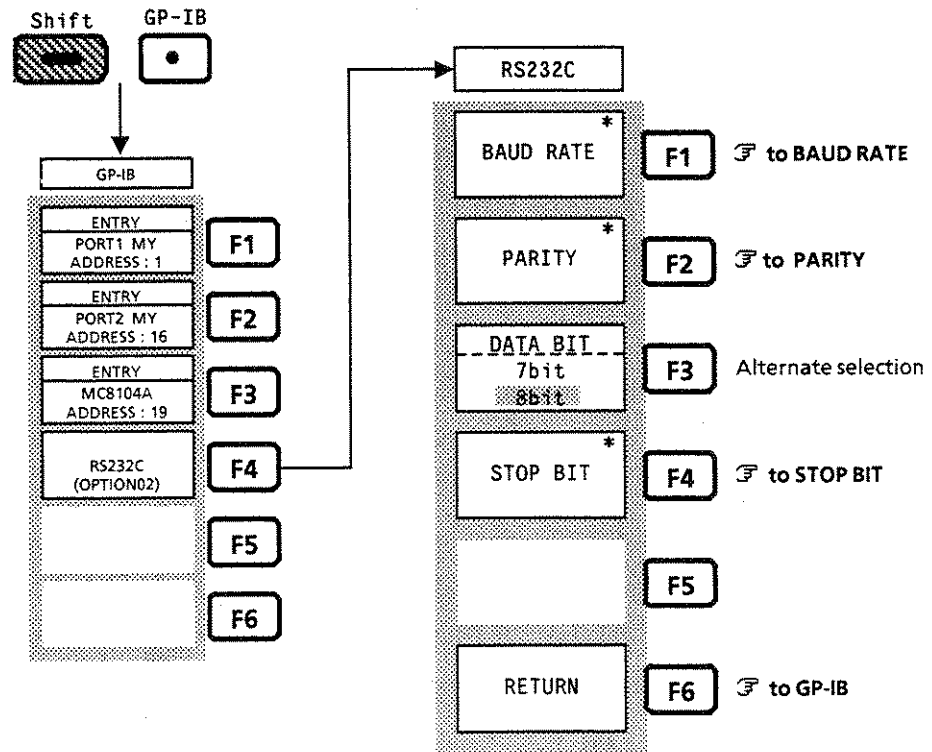
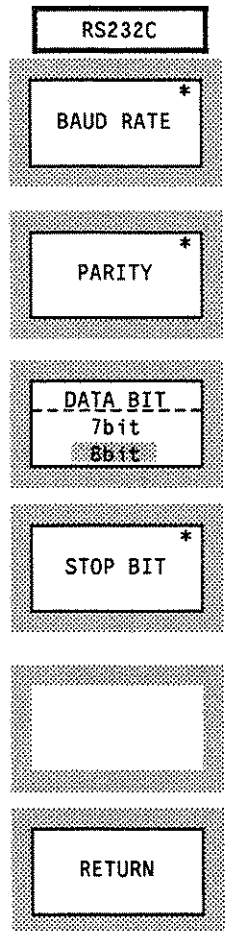

Specifies the memory number for saving	SAVE
	SAVE MEMORY No.
Displays the directory of the internal memory	MEM DIR
No function	
No function	
Displays the menu for setting the PMC parameters. ☞ to PMC	PMC *
No function	

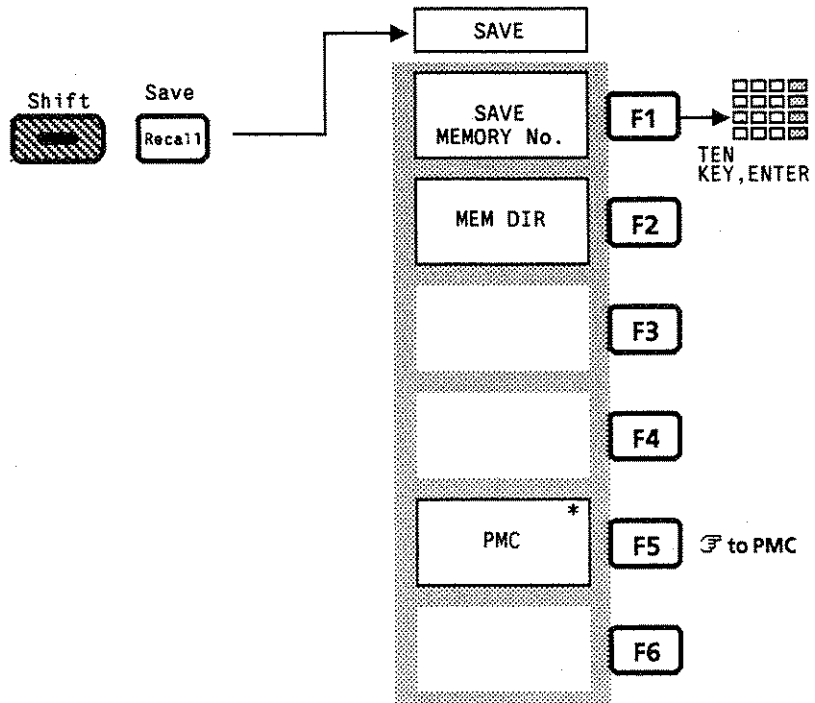

Sets the scroll step size to 1 div by using the Scroll [<] [>] key
Sets the scroll step size to 2 div by using the Scroll [<] [>] key
Sets the scroll step size to 5 div by using the Scroll [<] [>] key
Sets the scroll step size to 10 div by using the Scroll [<] [>] key
No function
Returns to the preceding menu. ↶ to FREQUENCY

SCROLL STEP
1div
2div
5div
10div
RETURN

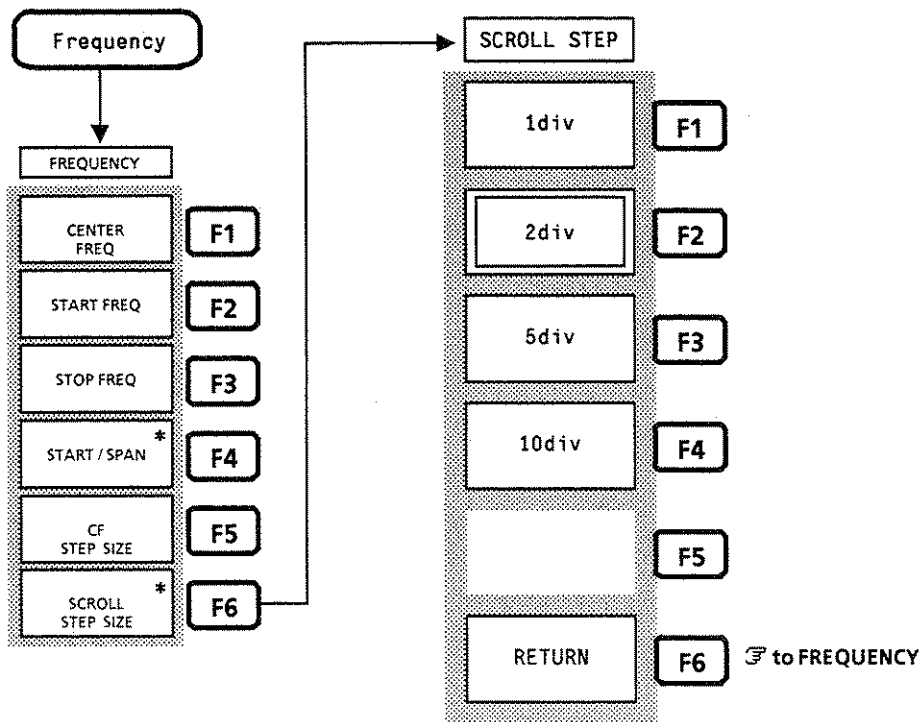

Makes an adjacent channel leakage power measurement by selecting both channels of the upper and lower sidebands
Makes an adjacent channel leakage power measurement by selecting the upper sideband channel only
Makes an adjacent channel leakage power measurement by selecting the lower sideband channel only
No function
Makes an adjacent channel leakage power measurement without specifying a channel. Select OFF for graph display only
Returns to the preceding menu. ↶ to ADJ CH MEAS

SELECT CH

BOTH SIDES

UPPER SIDE

LOWER SIDE

OFF

RETURN

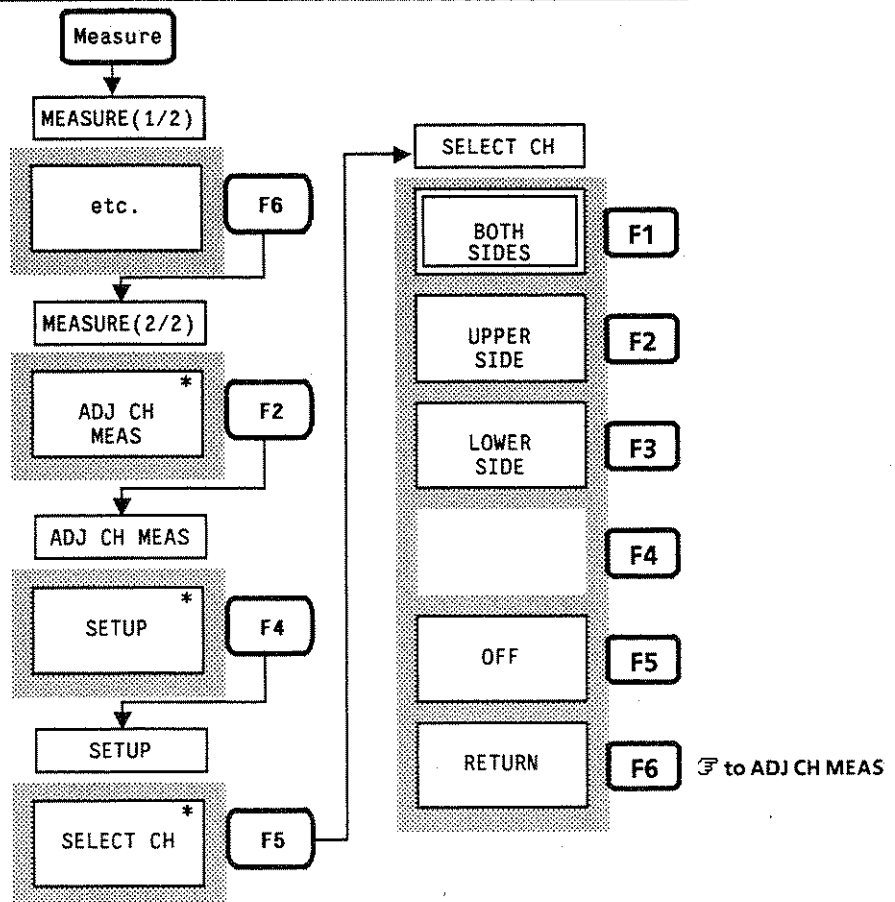

Specifies the correction data 1
Specifies the correction data 2
Specifies the correction data 3
Specifies the correction data 4
Specifies the correction data 5
Returns to the preceding menu. F2 to CORRECTION

- SELECT CORR
- CORR-1
- CORR-2
- CORR-3
- CORR-4
- CORR-5
- RETURN

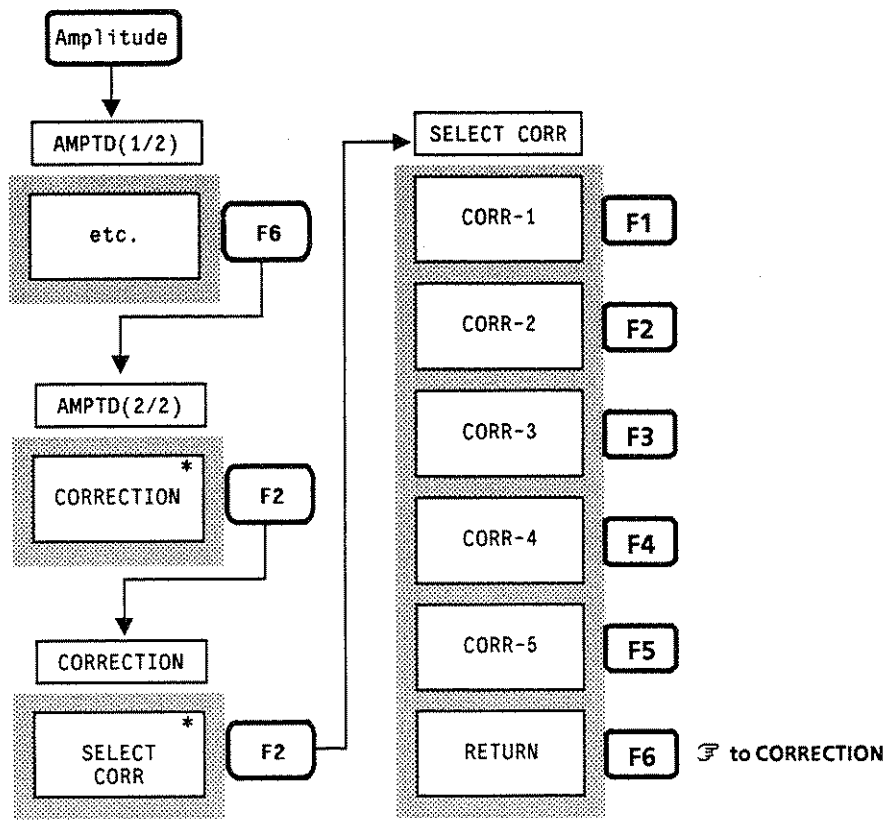

SELECT CORR

Selects the UPPER LINE 1 of the limit line to be created	SELECT LINE UPPER LINE1
Selects the LOWER LINE 1 of the limit line to be created	LOWER LINE1
Selects the UPPER LINE 2 of the limit line to be created	UPPER LINE2
Selects the LOWER LINE 2 of the limit line to be created	LOWER LINE2
No function	
Returns to the preceding menu. F to MAKE TEMP	RETURN

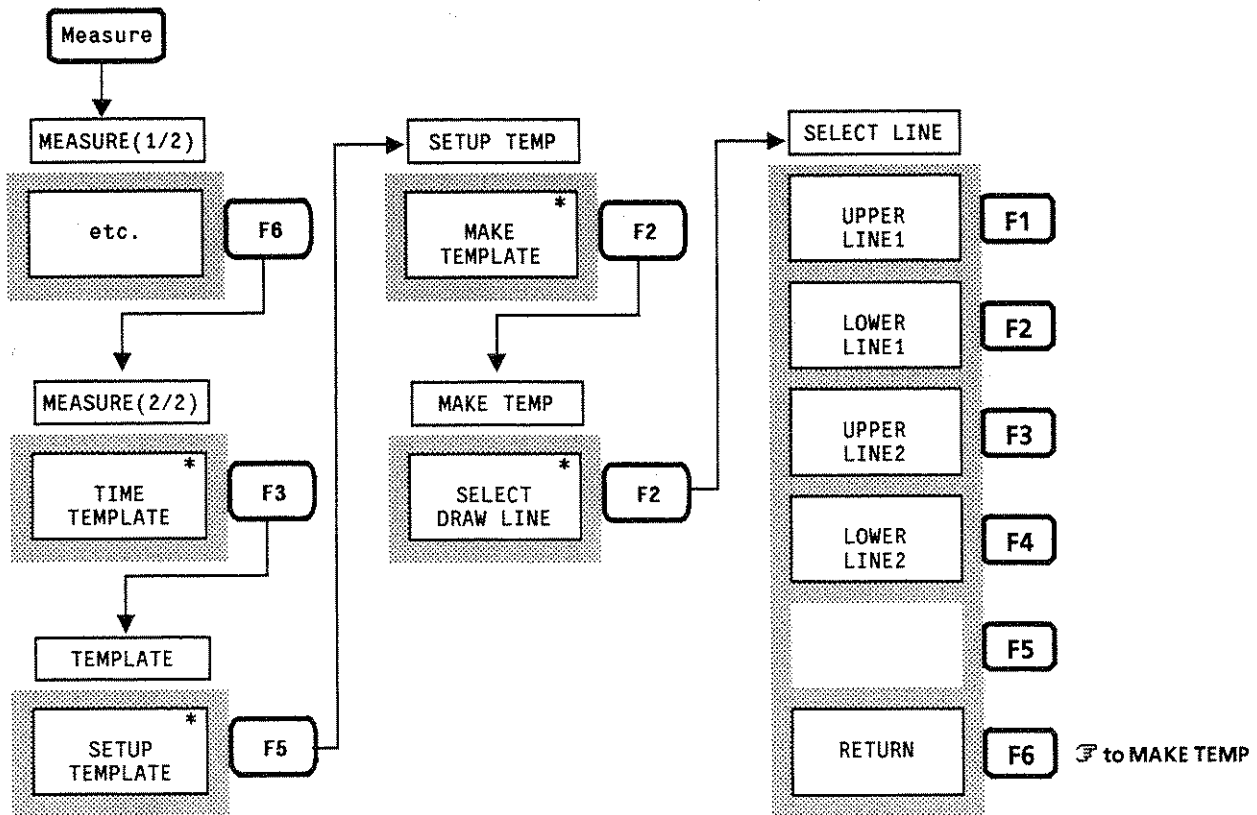

Selects the internal PMC for media	SELECT MEDIA INT PMC
Selects the external PMC1 for media	EXT PMC1
Selects the external PMC2 for media	EXT PMC2
Selects the external floppy disk for media	EXT FD
No function	
Returns to the preceding menu. F to PMC	RETURN

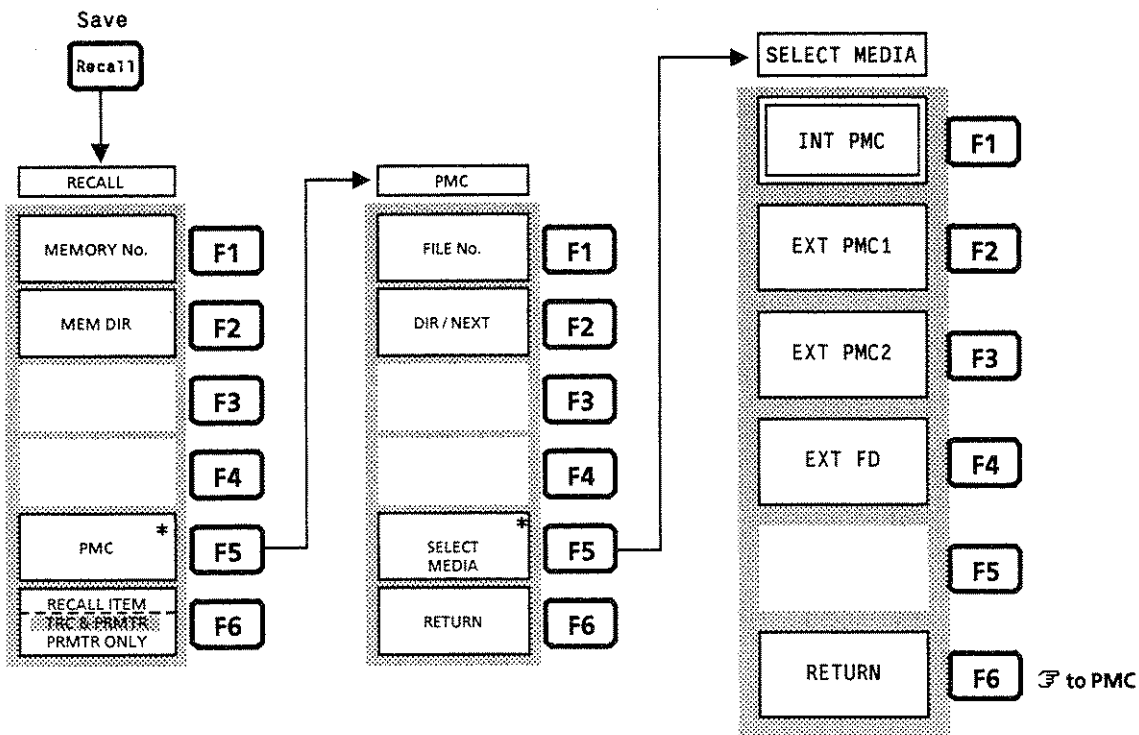

Selects the internal PMC for media	SELECT MEDIA INT PMC
Selects the external PMC1 for media	EXT PMC1
Selects the external PMC2 for media	EXT PMC2
Selects the external floppy disk for media	EXT FD
No function	
Returns to the preceding menu. ⇐ to PMC	RETURN

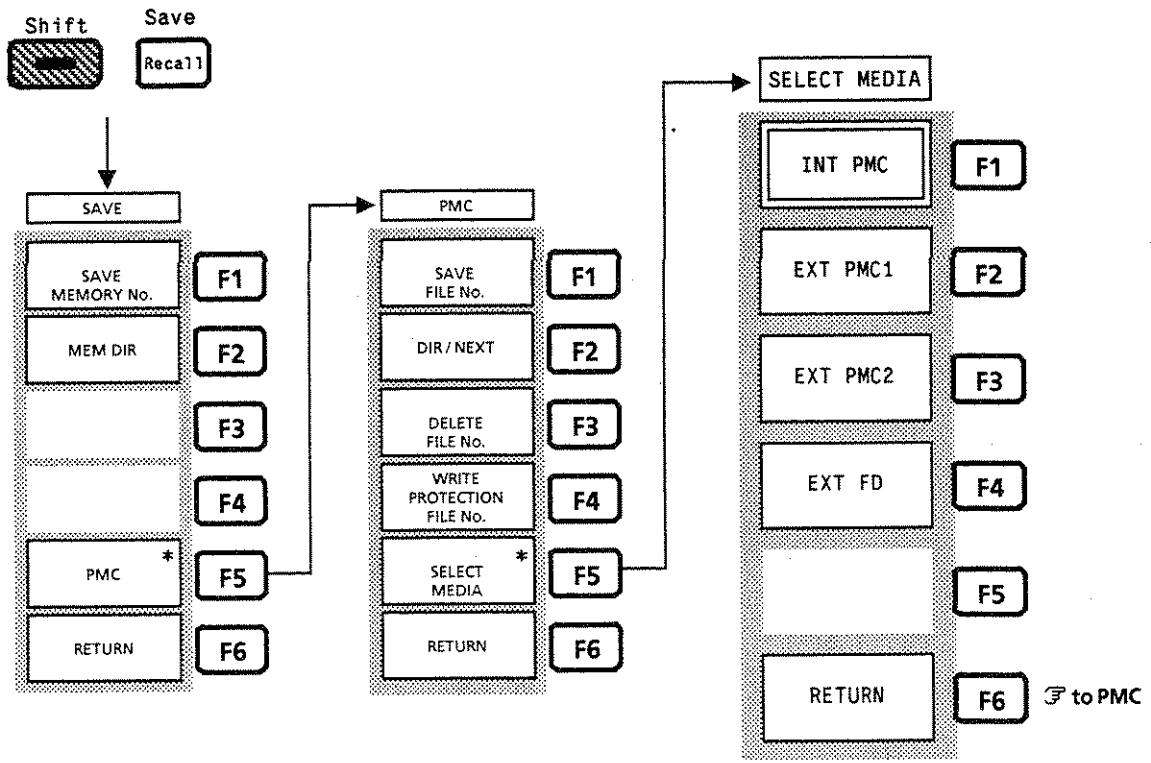

Selects the internal PMC for media
Selects the external PMC1 for media
Selects the external PMC2 for media
Selects the external floppy disk for media
No function
Returns to the preceding menu. ↩ to PMC

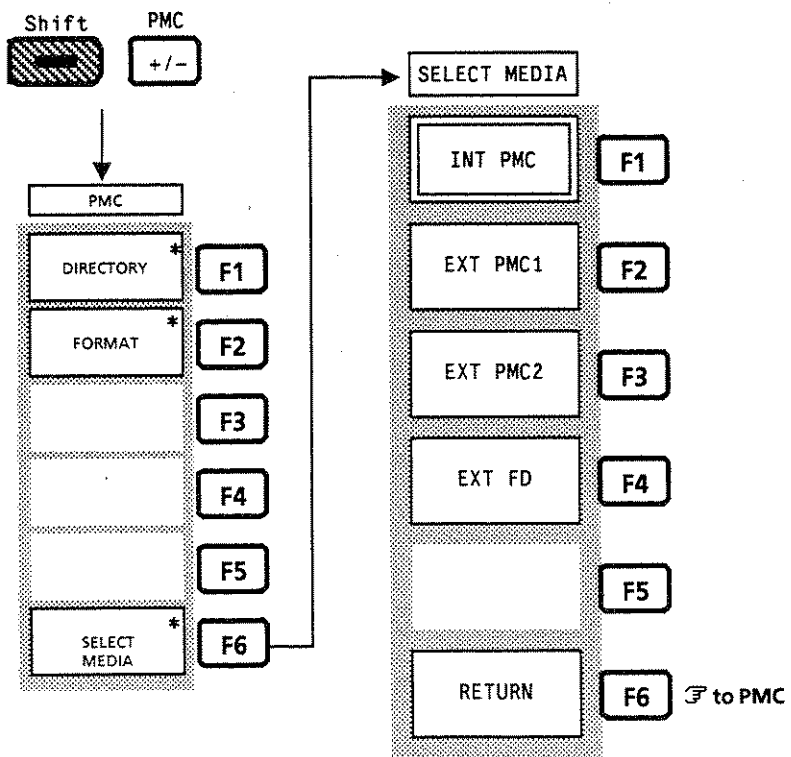
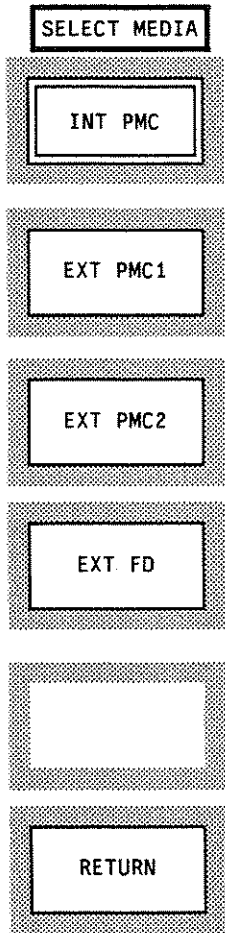

Displays the menu for setting template data 1. F to TEMP-1	SELECT TEMP TEMP-1 *
Displays the menu for setting template data 2. F to TEMP-2	TEMP-2 *
Displays the menu for setting template data 3. F to TEMP-3	TEMP-3 *
Displays the menu for setting template data 4. F to TEMP-4	TEMP-4 *
Displays the menu for setting template data 5. F to TEMP-5	TEMP-5 *
Returns to the preceding menu. F to TEMPLATE	RETURN

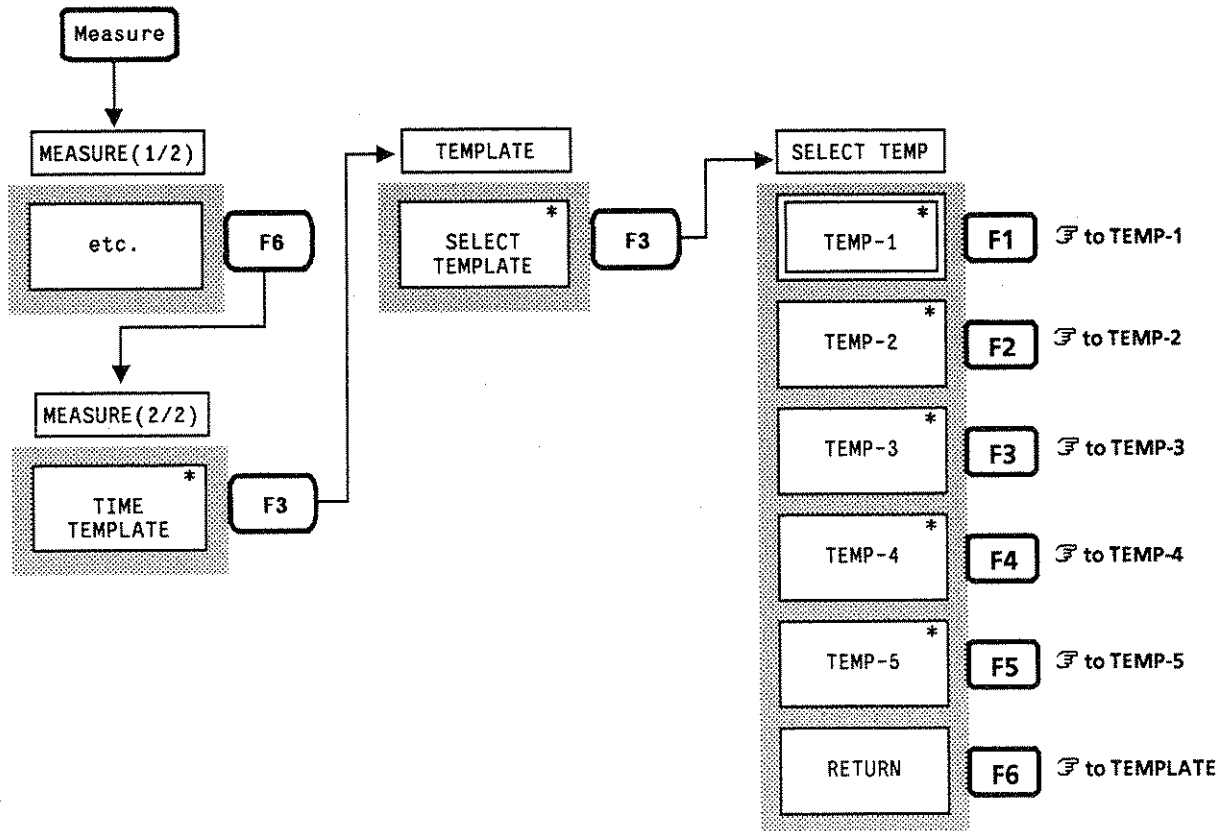

Specifies TEMP-1 to create the template data
Specifies TEMP-2 to create the template data
Specifies TEMP-3 to create the template data
Specifies TEMP-4 to create the template data
Specifies TEMP-5 to create the template data
Returns to the preceding menu. ↩ to SETUP TEMP

SELECT TEMP

TEMP-1

TEMP-2

TEMP-3

TEMP-4

TEMP-5

RETURN

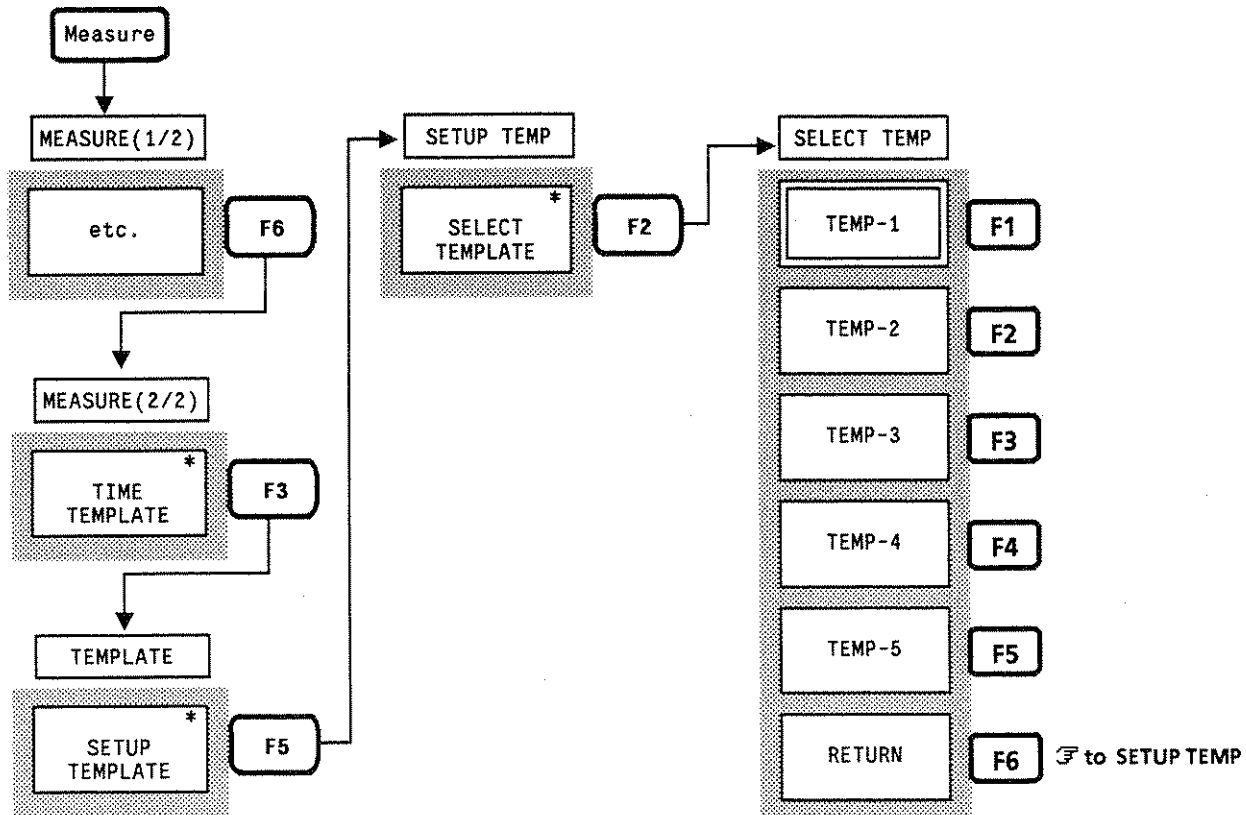

SELECT TEMP

Selects N% or X dB DOWN method for the occupied frequency bandwidth measurement procedure
Sets the value of "N" in the N% method
Sets the value of "X" in the X dB DOWN method
No function
No function
Returns to the preceding menu. ↩ to OBW MEAS

SETUP

OBW
 N% of POWER
 XdB DOWN

ENTRY
 N%
 99%

ENTRY
 XdB
 25dB

RETURN

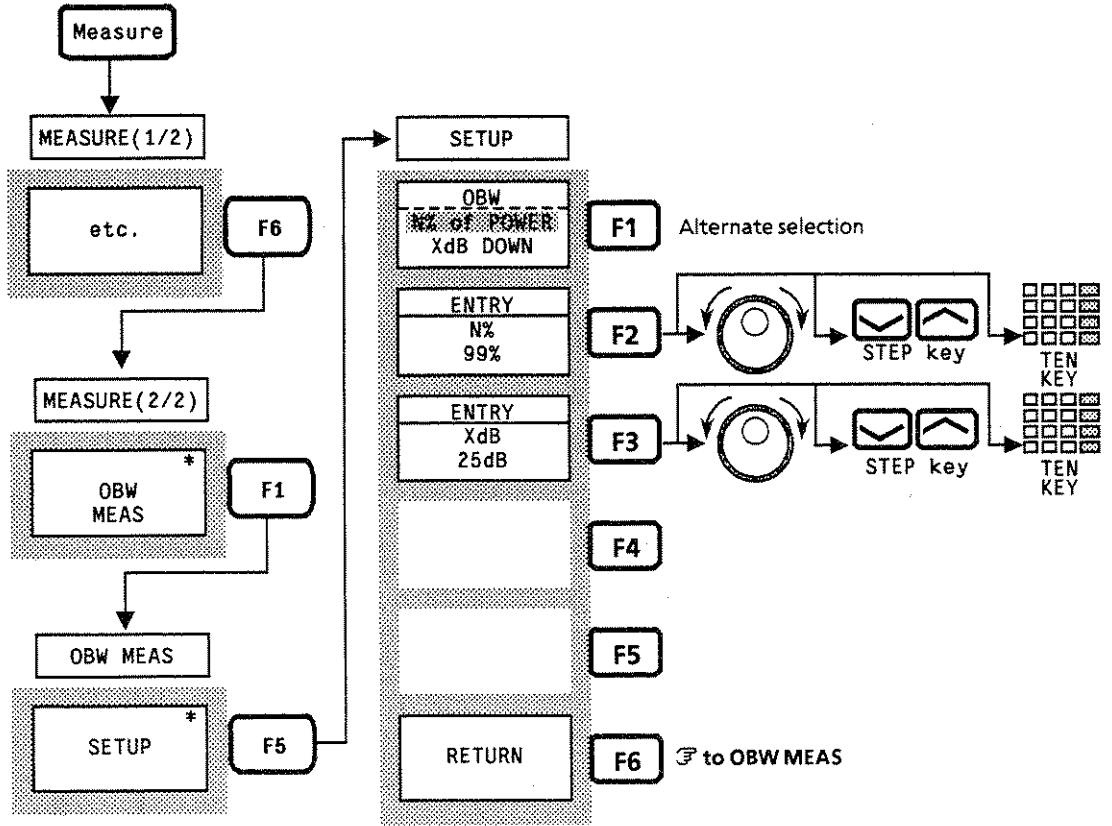

Selects R: TOTAL PWR or R: REF LEVEL for the adjacent channel leakage power measurement method
Sets the graph display to ON or OFF
Turns ON or OFF the vertical line that indicate the center frequency of the desired wave and adjacent channel
Turns ON or OFF the vertical line that indicate the bandwidth of the desired wave and adjacent channel
Displays the menu for selecting an adjacent channel for measurement. F5 to SELECT CH
Returns to the preceding menu. F6 to ADJ CH MEAS

SETUP

METHOD
R: TOTAL PWR
R: REF LEVEL

GRAPH
ON
OFF

CH_CTR_LINE
ON
OFF

CH_BW_LINE
ON
OFF

SELECT CH *

RETURN

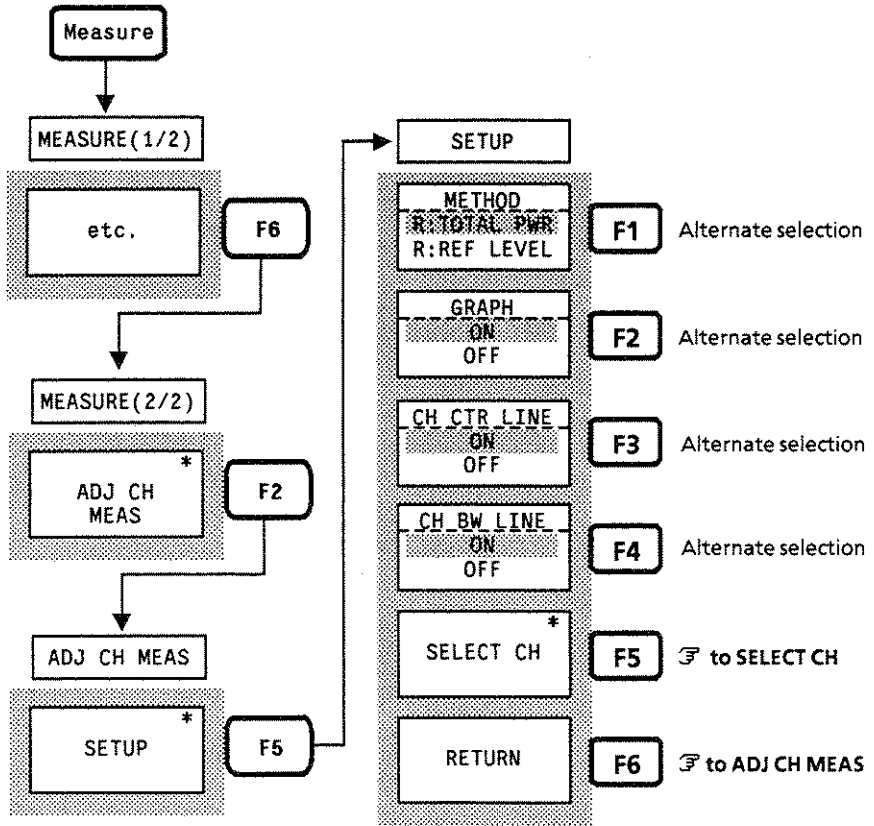

SETUP

Selects HP-GL or GP-GL system plotter
Displays the menu for selecting paper and plot sizes. ↻ to PAPER SIZE
Displays the menu for selecting the plot location when a quarter size of the paper area is specified as a plotting size. ↻ to LOCATION
Displays the menu for selecting the items to plot. ↻ to ITEM
Sets the plotter GPIB address
Returns to the preceding menu. ↻ to COPY CONT

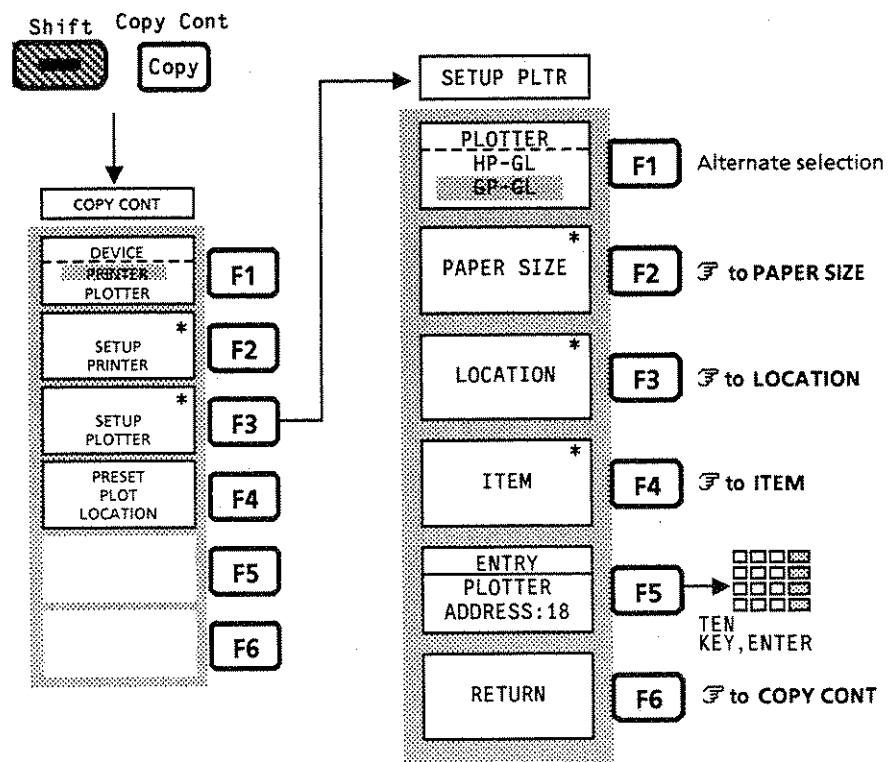
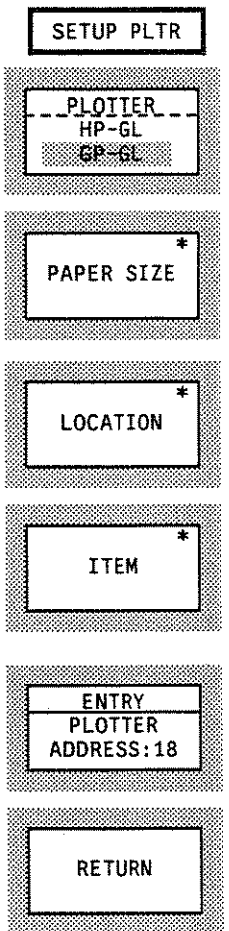

Sets the printer to HP2225	SETUP PTR HP2225
Sets the printer to EPSON VP-800	EPSON VP-800
Sets the printer to UA455A	UA455A
Selects the MC8104A built-in printer	MC8104A
Sets the printer to the GPIB address	ENTRY PRINTER ADDRESS: 17
Returns to the preceding menu. ⌘ to COPY CONT	RETURN

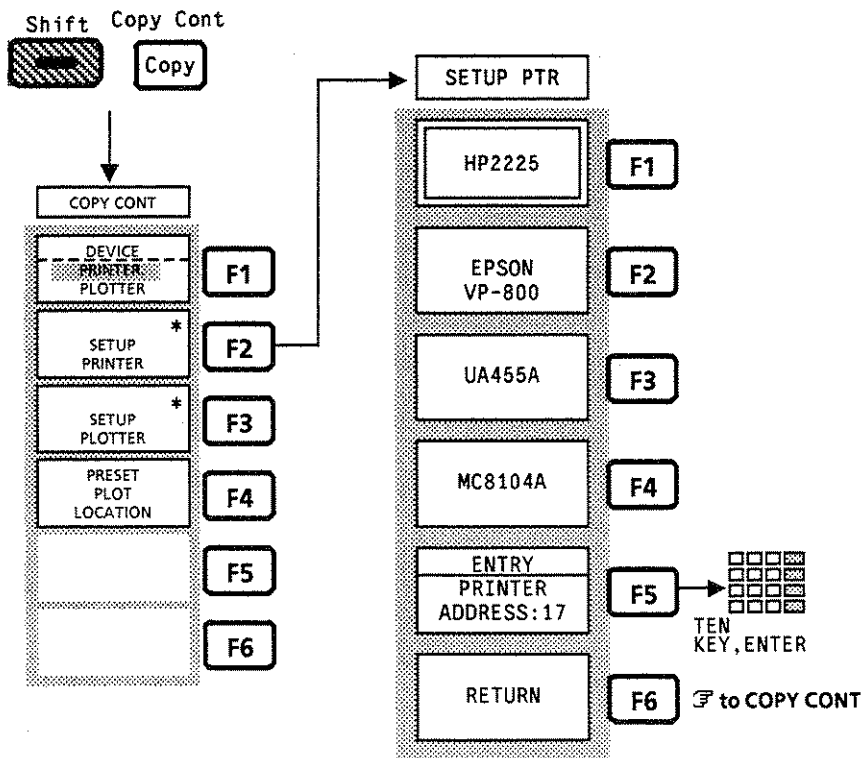

Displays the menu for selecting the template. F3 to SELECT TEMP	<div style="border: 1px solid black; padding: 2px; text-align: center;">SETUP TEMP</div> <div style="border: 1px solid black; padding: 2px; text-align: center;">* SELECT TEMPLATE</div>
Displays the menu for creating template. F3 to MAKE TEMP	<div style="border: 1px solid black; padding: 2px; text-align: center;">* MAKE TEMPLATE</div>
No function	<div style="border: 1px solid black; padding: 2px; text-align: center;"> </div>
No function	<div style="border: 1px solid black; padding: 2px; text-align: center;"> </div>
No function	<div style="border: 1px solid black; padding: 2px; text-align: center;"> </div>
Returns to the preceding menu. F3 to TEMPLATE	<div style="border: 1px solid black; padding: 2px; text-align: center;">RETURN</div>

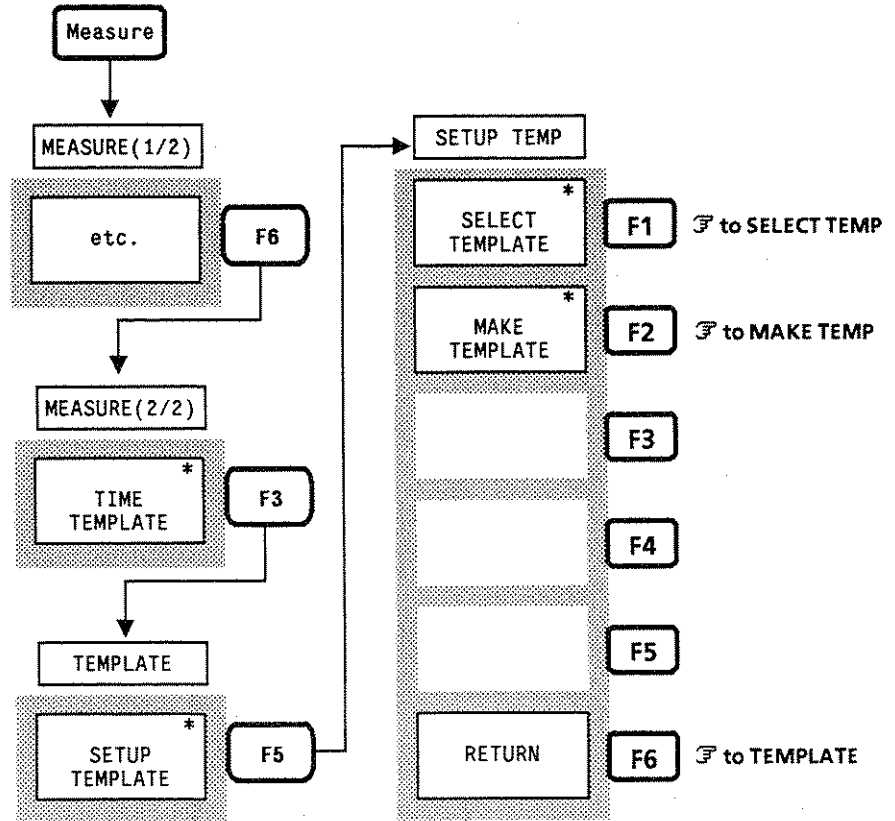

Demodulates AM wave to monitor the sound	SOUND AM
Demodulates FM wave to monitor the sound	FM
Turns off the sound-monitoring function	OFF
No function	
No function	
Adjusts the sound monitor volume	ENTRY VOLUME 10

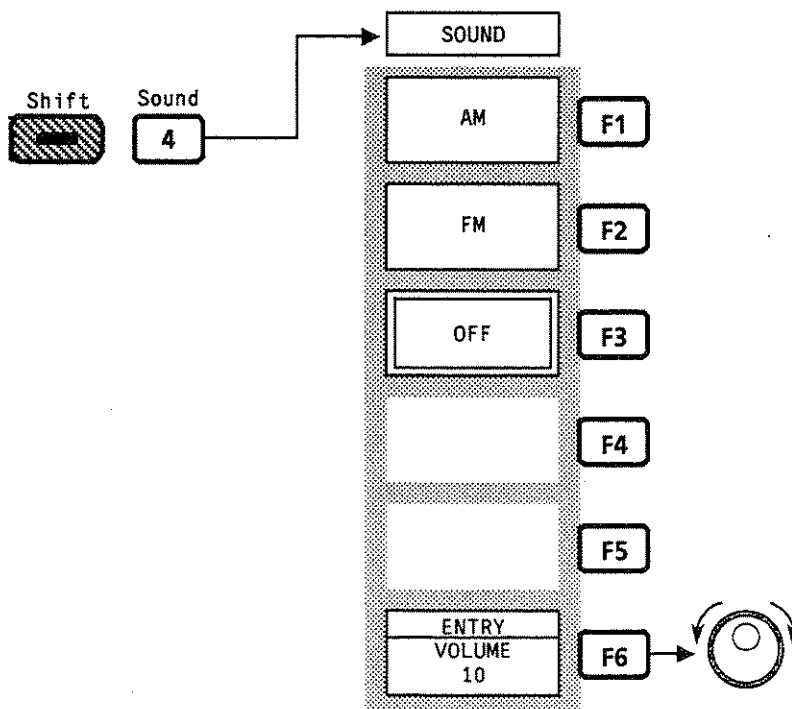

Sets the frequency span to full span (0 to 8.5 GHz)
Sets the frequency span to zero span (time domain)
Sets the AUTO BAND, which selects the optimum band according to the observation frequency range
Fixes the frequency band to BAND 0 (0 to 2 GHz)
Fixes the frequency band to BAND 1 ⁻ (1.7 to 7.5 GHz)
Fixes the frequency band to BAND 1 ⁺ (6.5 to 8.5 GHz)

SPAN
FULL SPAN
ZERO SPAN
AUTO BAND
MANUAL BAND 0 0-2 GHz
MANUAL BAND 1- 1.7-7.5GHz
MANUAL BAND 1+ 6.5-8.5GHz

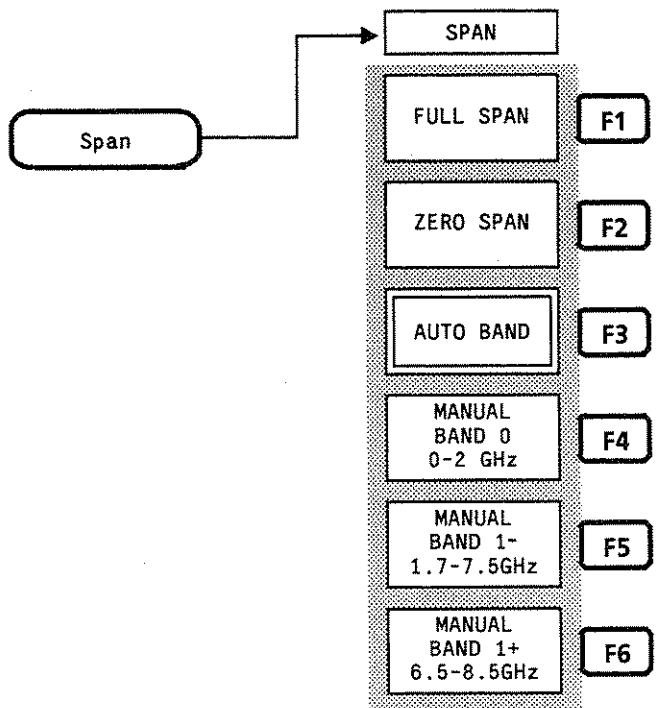

Sets the start frequency
Sets the frequency span
No function
No function
No function
Returns to the preceding menu. ↶ to FREQUENCY

START/SPAN
START FREQ
FREQ SPAN
RETURN

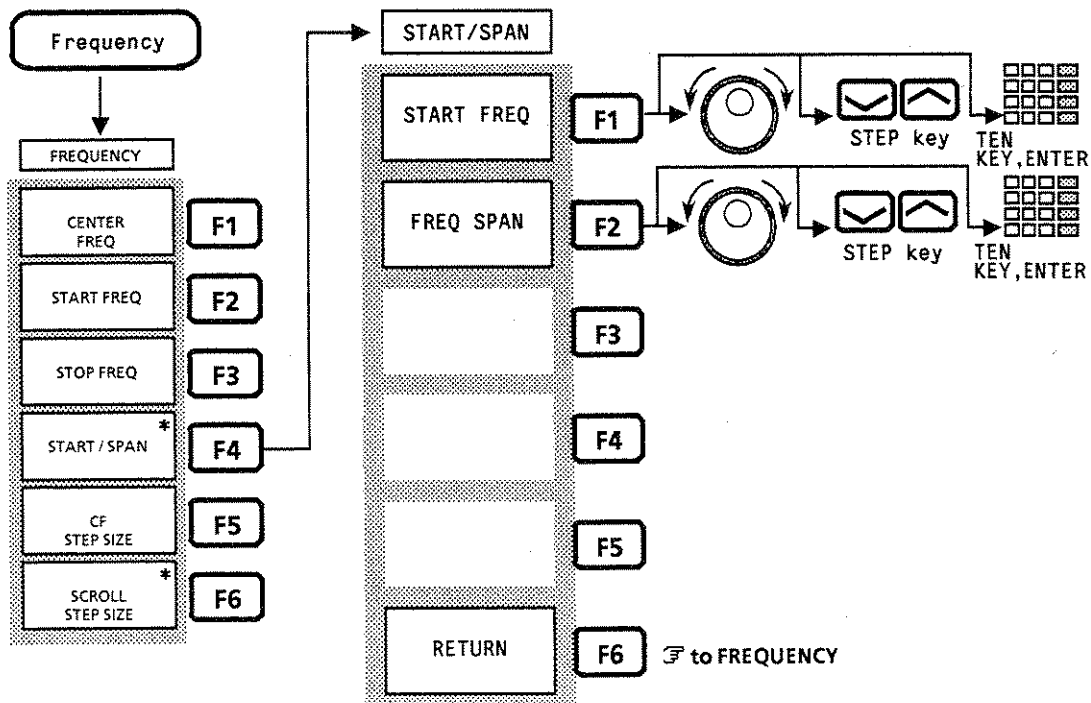

Sets the stop bit to 1 bit	STOP BIT 1bit
Sets the stop bit to 1.5 bits	1.5bit
Sets the stop bit to 2 bits	2bit
No function	
No function	
Returns to the preceding menu. ↩ to RS232C	RETURN

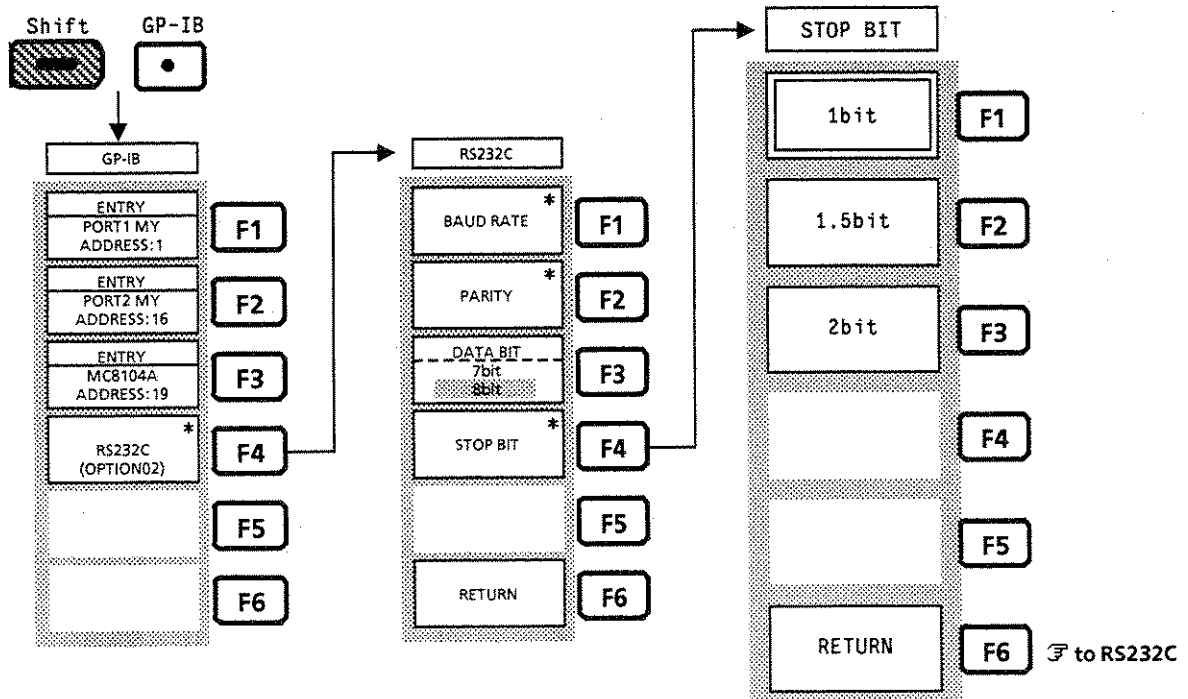

<p>Sets the trace TIME storage mode to NORMAL. NORMAL: Renews and displays trace data at each sweep. This is used for normal measurement.</p>
<p>Displays the menu for selecting the trace TIME storage mode from the MAX, MIN, and AVG parameters. ☞ to MAX / MIN / AVG</p>
<p>Displays the menu for selecting the trace TIME storage mode from CUMULATIVE or OVER WRITE. ☞ to CUM / OVER</p>
<p>Sets the trace TIME storage mode to VIEW. VIEW: Continues displaying the waveform as it is without refreshing the currently-displayed trace data. This mode is used to observe a waveform with the trace data stopped.</p>
<p>Displays the menu for selecting the trace Time detection mode. ☞ to DET MODE</p>
<p>Returns to the preceding menu. ☞ to TIME</p>

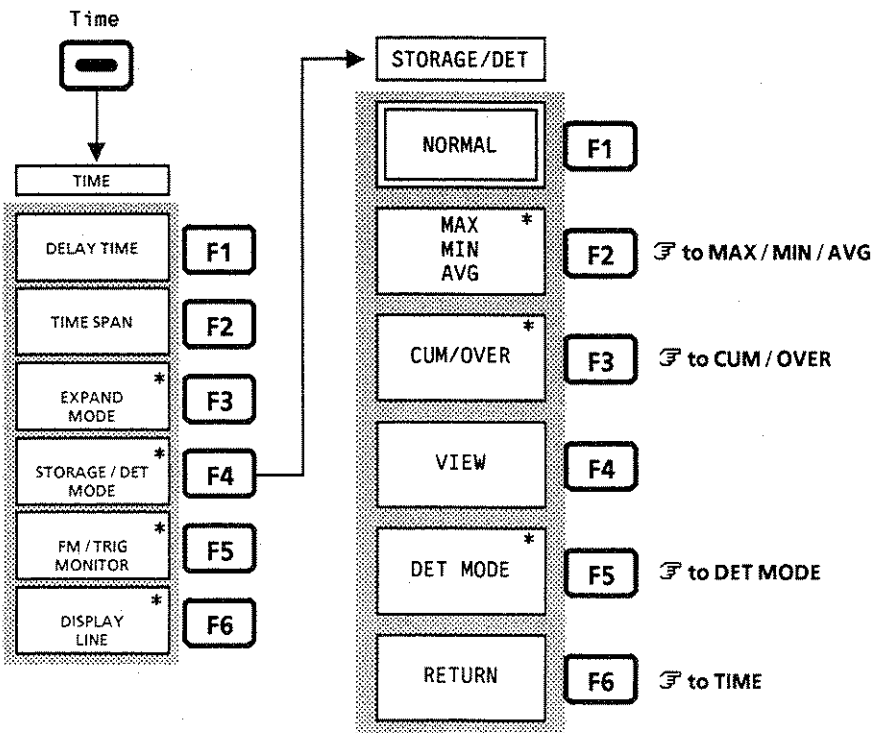
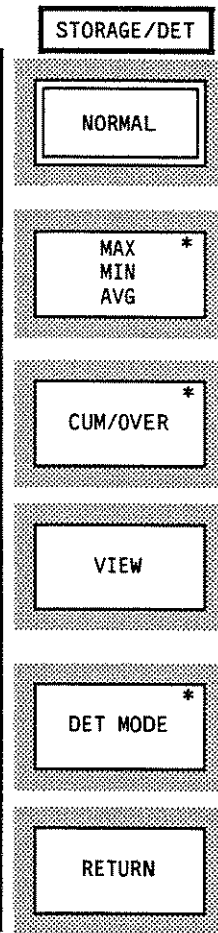

Indicates that the SWP TIME function is set in MANUAL mode. Pressing this key in AUTO mode changes to MANUAL mode.
Indicates that the SWP TIME function is set in AUTO mode. Pressing this key in MANUAL mode changes to AUTO mode.
No function
No function
The manual RBW, VBW and Swp Time functions return to AUTO control
All the values of the coupled function return to AUTO control

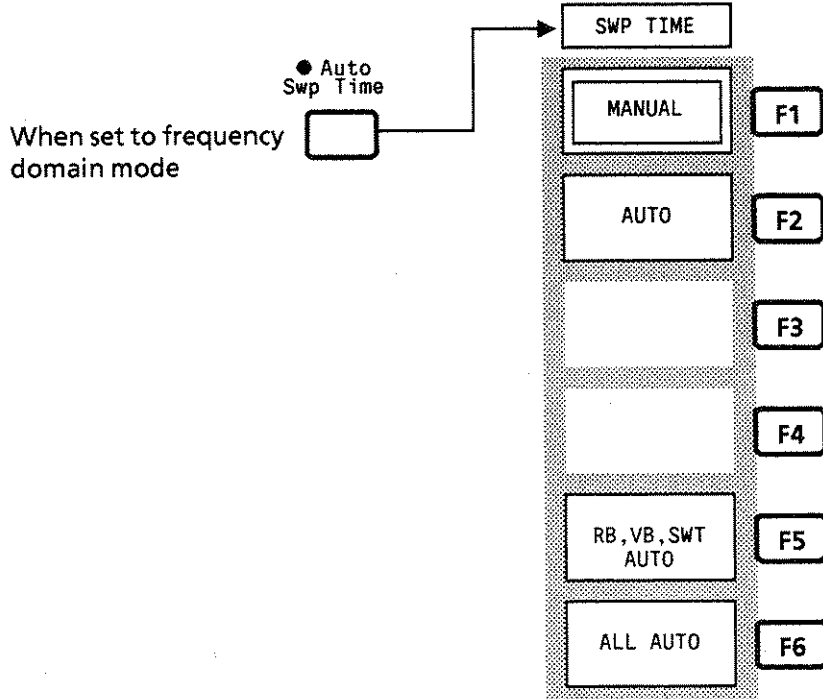
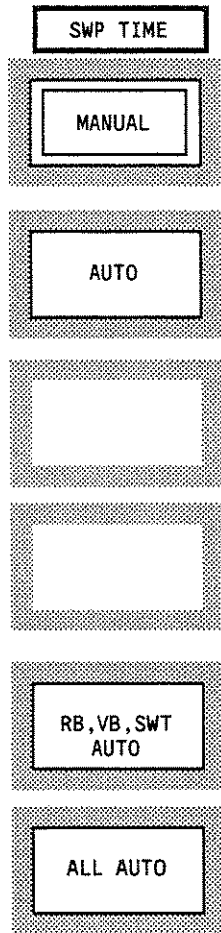

Sets the TIME SPAN
No function
No function
No function
No function
No function

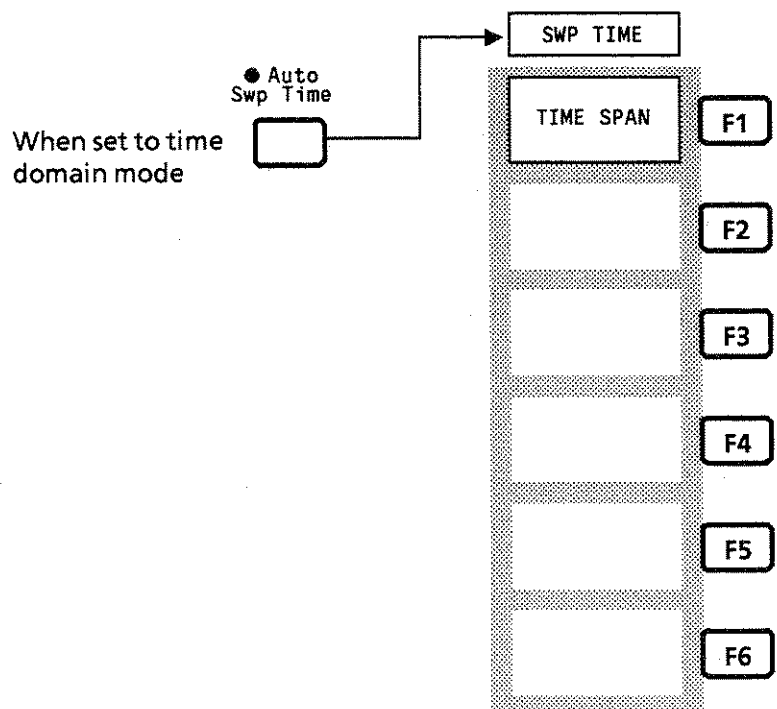
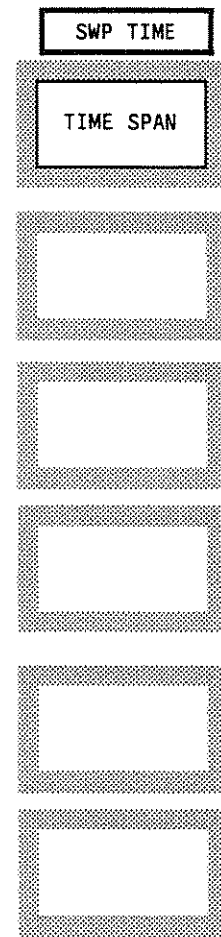

No function
Selects the AUTO SWT setting conditions
No function
Selects the number of data points for NORMAL or DOUBLE
Switching Common / independent settings for coupled function between frequency domain and time domain.
Set the date/time.

SYSTEM

AUTO SWT
NORMAL
FAST

DATA POINTS
501
1002

COUPLE MODE
COMMON
INDEPENDENT

DATE/TIME *

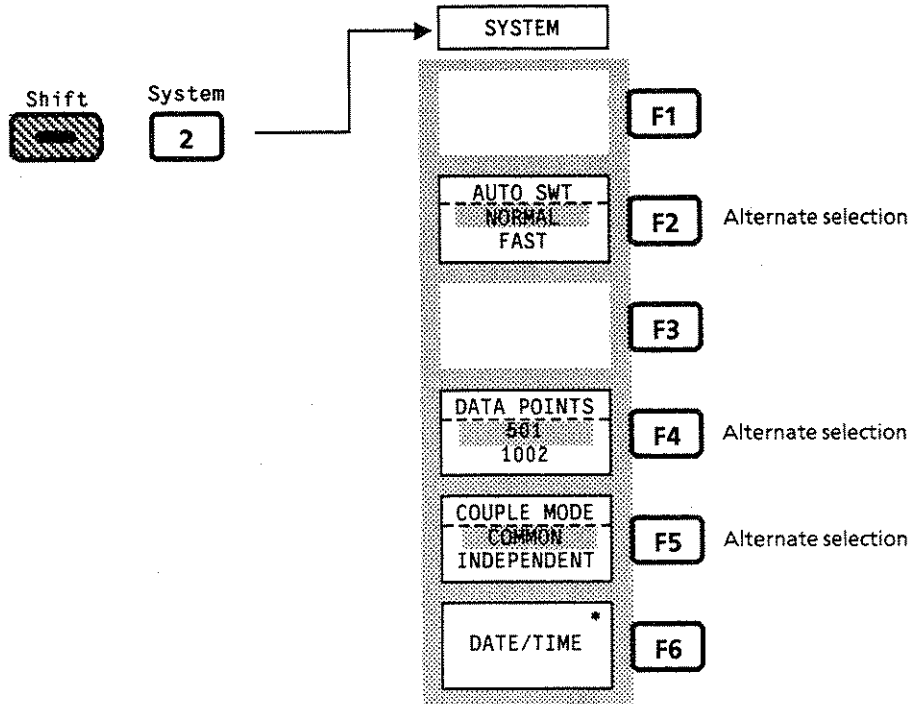

Uses the template to execute waveform check
No function
Displays the menu for selecting template data. F3 to SELECT TEMP
Displays the menu for moving the template. F3 to MOVE TEMP
Displays the menu for creating the template. F3 to SETUP TEMP
Returns to the preceding menu. F3 to MEASURE (2 / 2)

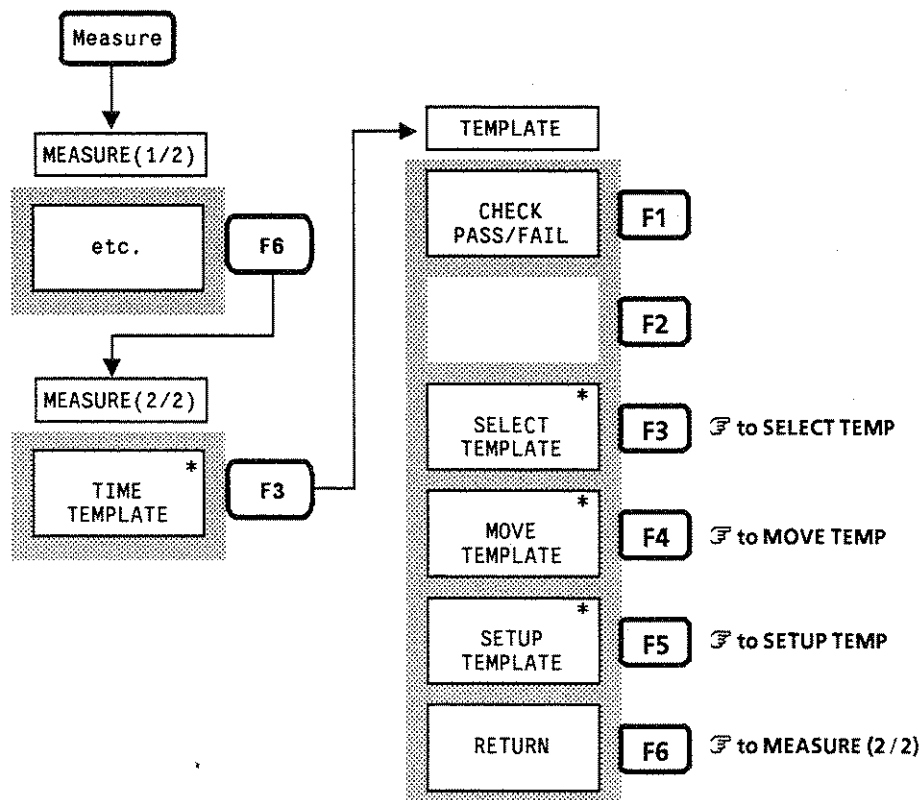
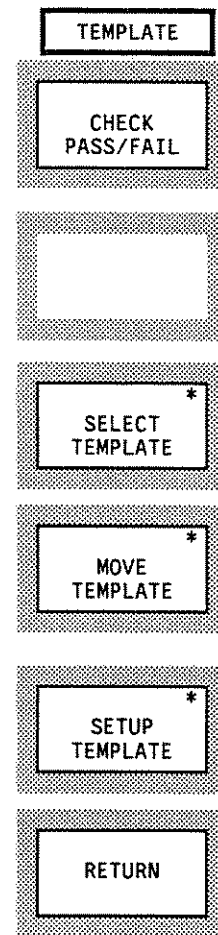

Sets the LIMIT-1 UPPER line to ON or OFF
Sets the LIMIT-1 LOWER line to ON or OFF
Sets the LIMIT-2 UPPER line to ON or OFF
Sets the LIMIT-2 LOWER line to ON or OFF
No function
Returns to the preceding menu. F6 to SELECT TEMP

TEMP-1

LIMIT-1
UPPER
ON OFF

LIMIT-1
LOWER
ON OFF

LIMIT-2
UPPER
ON OFF

LIMIT-2
LOWER
ON OFF

RETURN

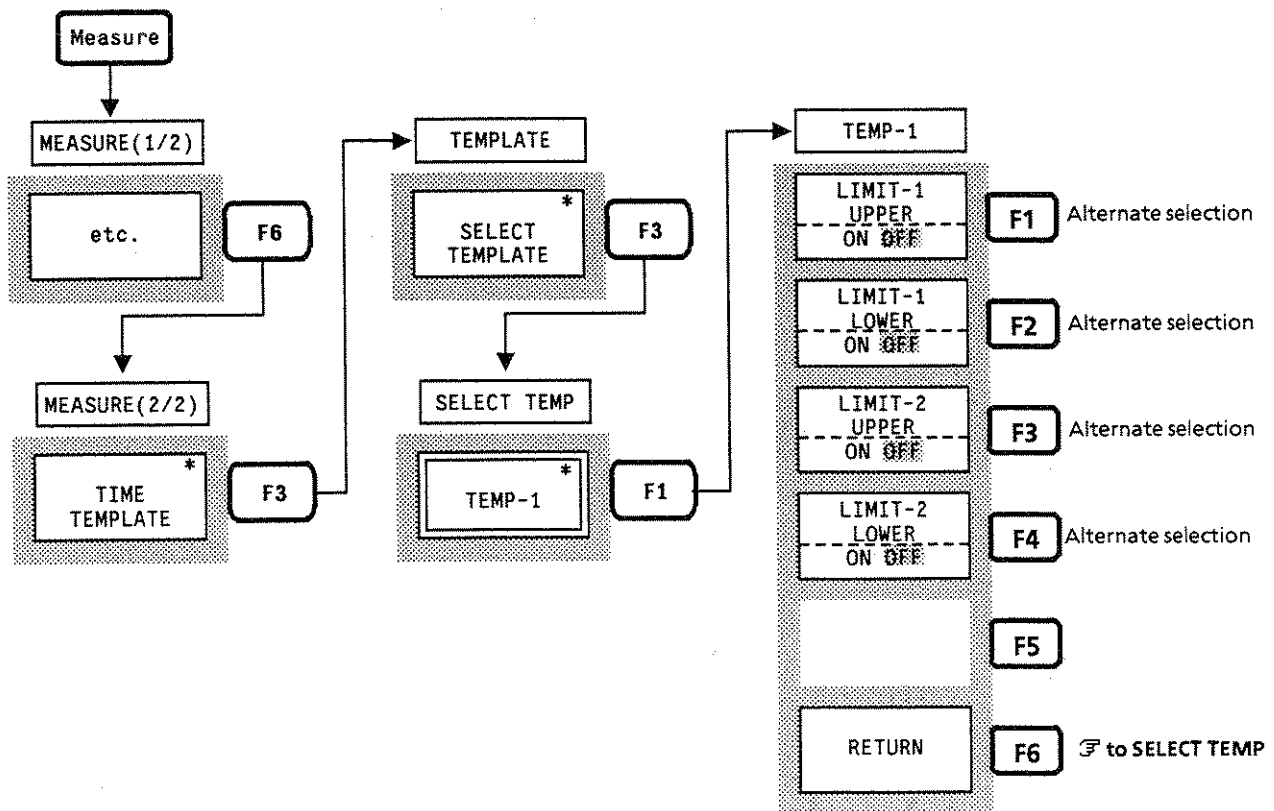

Sets the LIMIT-1 UPPER line to ON or OFF
Sets the LIMIT-1 LOWER line to ON or OFF
Sets the LIMIT-2 UPPER line to ON or OFF
Sets the LIMIT-2 LOWER line to ON or OFF
No function
Returns to the preceding menu. F6 to SELECT TEMP

TEMP-2

LIMIT-1
UPPER
ON OFF

LIMIT-1
LOWER
ON OFF

LIMIT-2
UPPER
ON OFF

LIMIT-2
LOWER
ON OFF

RETURN

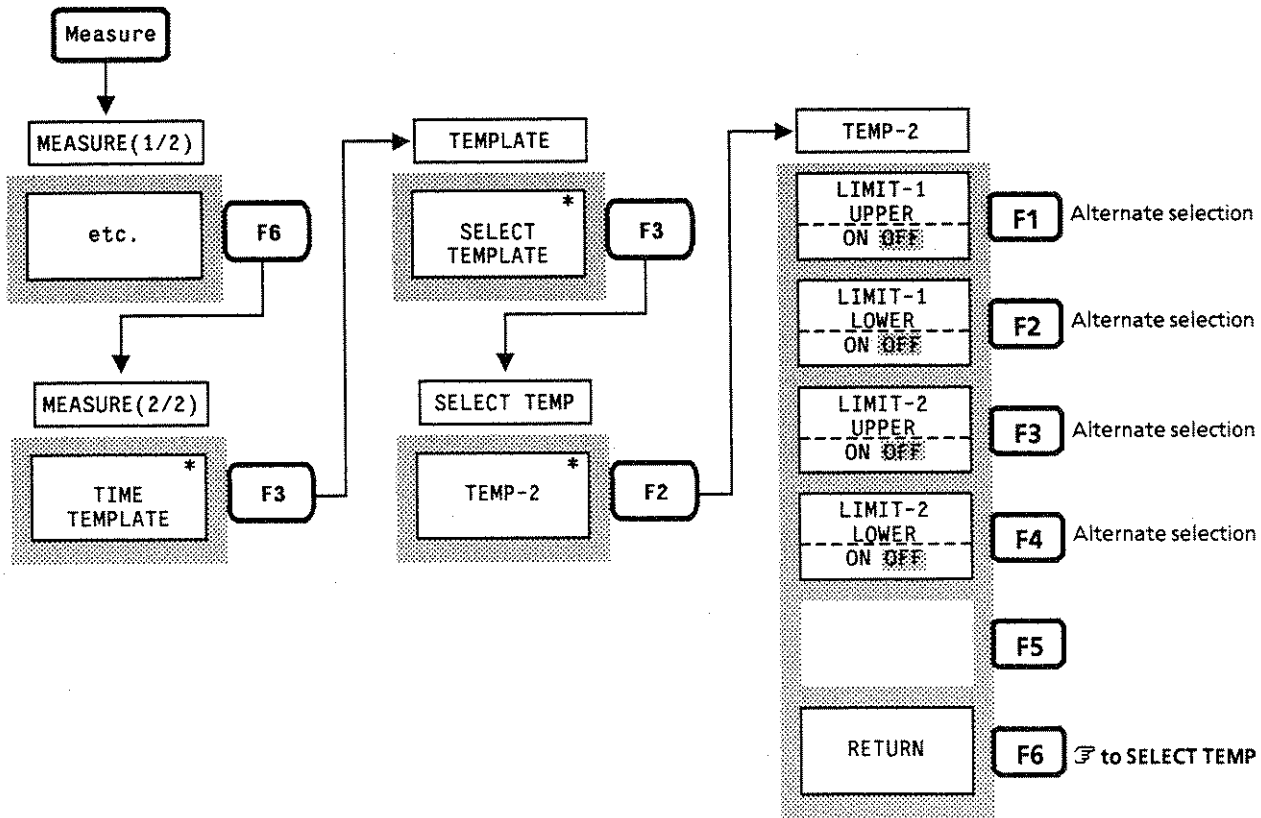

Sets the LIMIT-1 UPPER line to ON or OFF
Sets the LIMIT-1 LOWER line to ON or OFF
Sets the LIMIT-2 UPPER line to ON or OFF
Sets the LIMIT-2 LOWER line to ON or OFF
No function
Returns to the preceding menu. F3 to SELECT TEMP

TEMP-3

LIMIT-1
UPPER
ON OFF

LIMIT-1
LOWER
ON OFF

LIMIT-2
UPPER
ON OFF

LIMIT-2
LOWER
ON OFF

RETURN

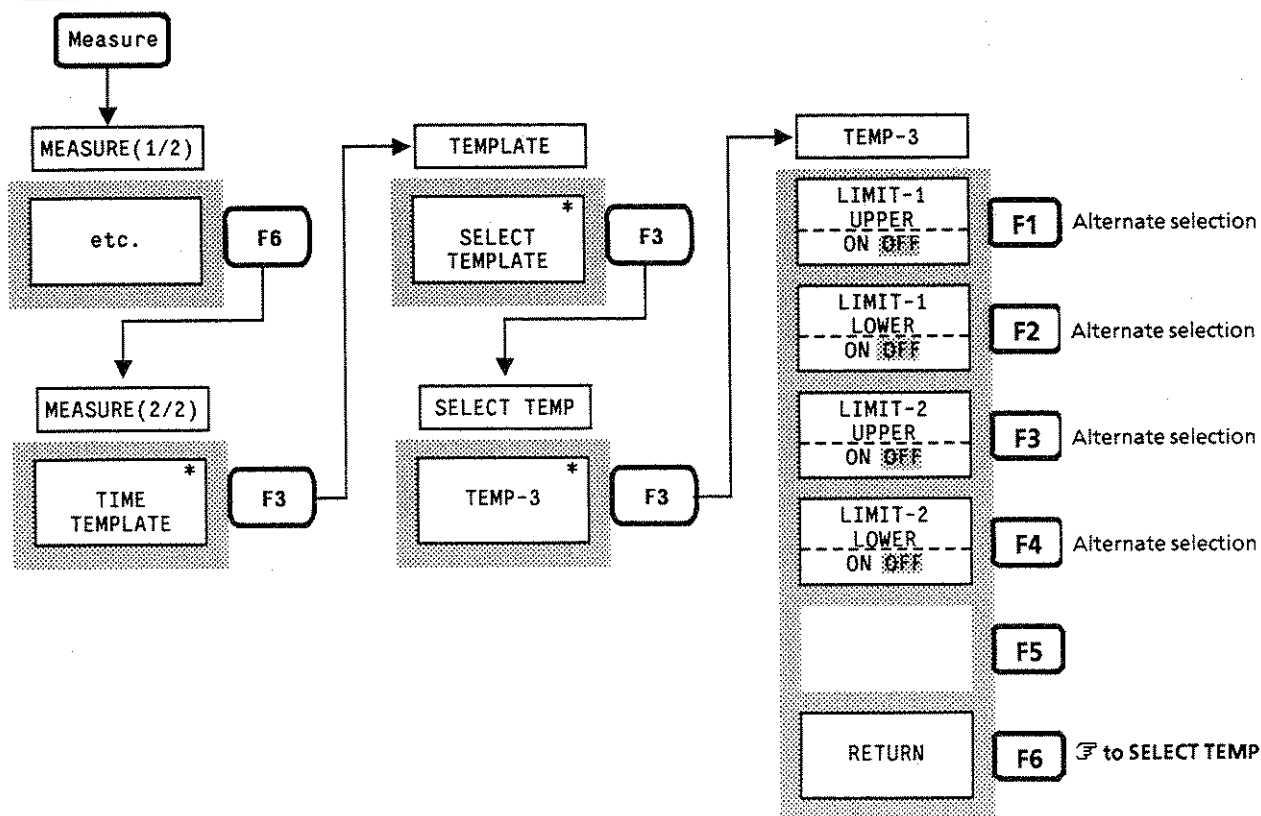

Sets the LIMIT-1 UPPER line to ON or OFF
Sets the LIMIT-1 LOWER line to ON or OFF
Sets the LIMIT-2 UPPER line to ON or OFF
Sets the LIMIT-2 LOWER line to ON or OFF
No function
Returns to the preceding menu. ↶ to SELECT TEMP

TEMP-4

LIMIT-1
UPPER
ON OFF

LIMIT-1
LOWER
ON OFF

LIMIT-2
UPPER
ON OFF

LIMIT-2
LOWER
ON OFF

RETURN

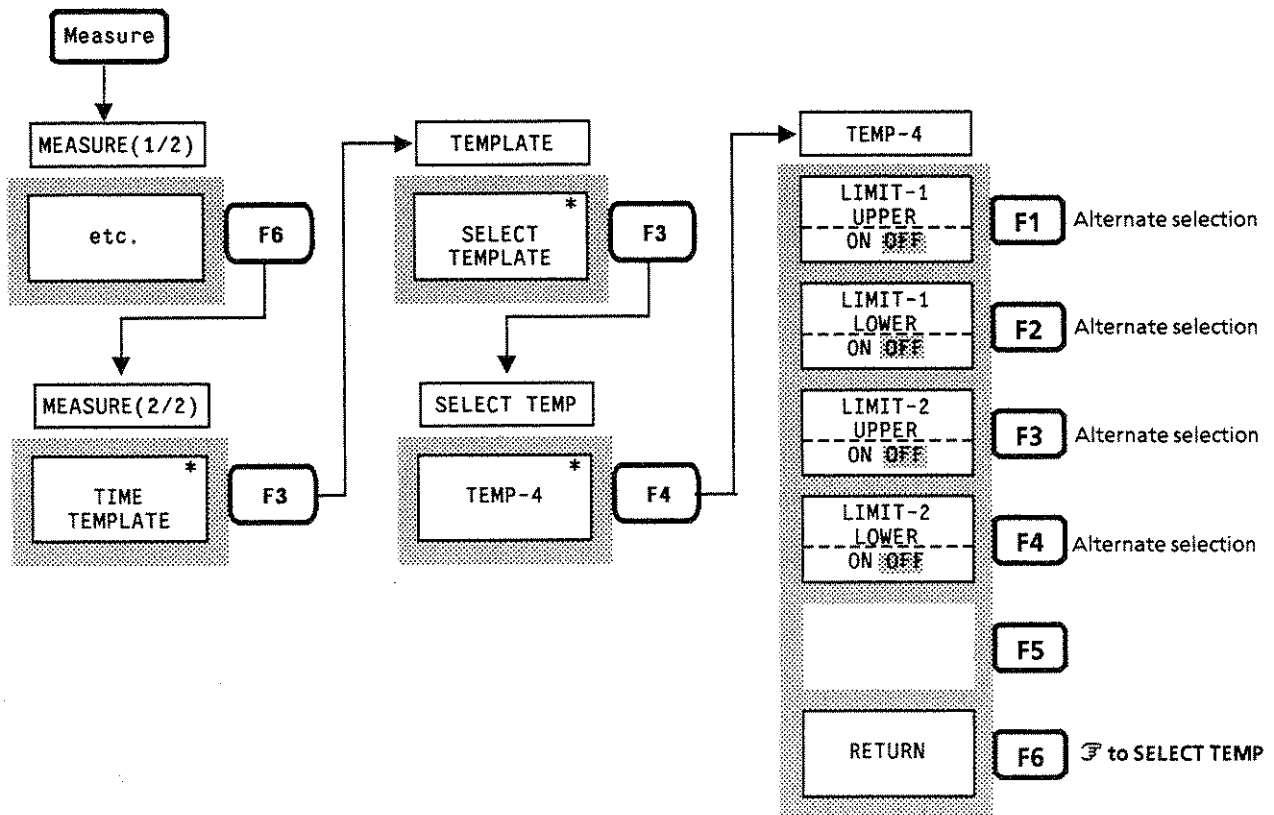

Sets the LIMIT-1 UPPER line to ON or OFF	TEMP-5 LIMIT-1 UPPER ON OFF
Sets the LIMIT-1 LOWER line to ON or OFF	LIMIT-1 LOWER ON OFF
Sets the LIMIT-2 UPPER line to ON or OFF	LIMIT-2 UPPER ON OFF
Sets the LIMIT-2 LOWER line to ON or OFF	LIMIT-2 LOWER ON OFF
No function	
Returns to the preceding menu. F6 to SELECT TEMP	RETURN

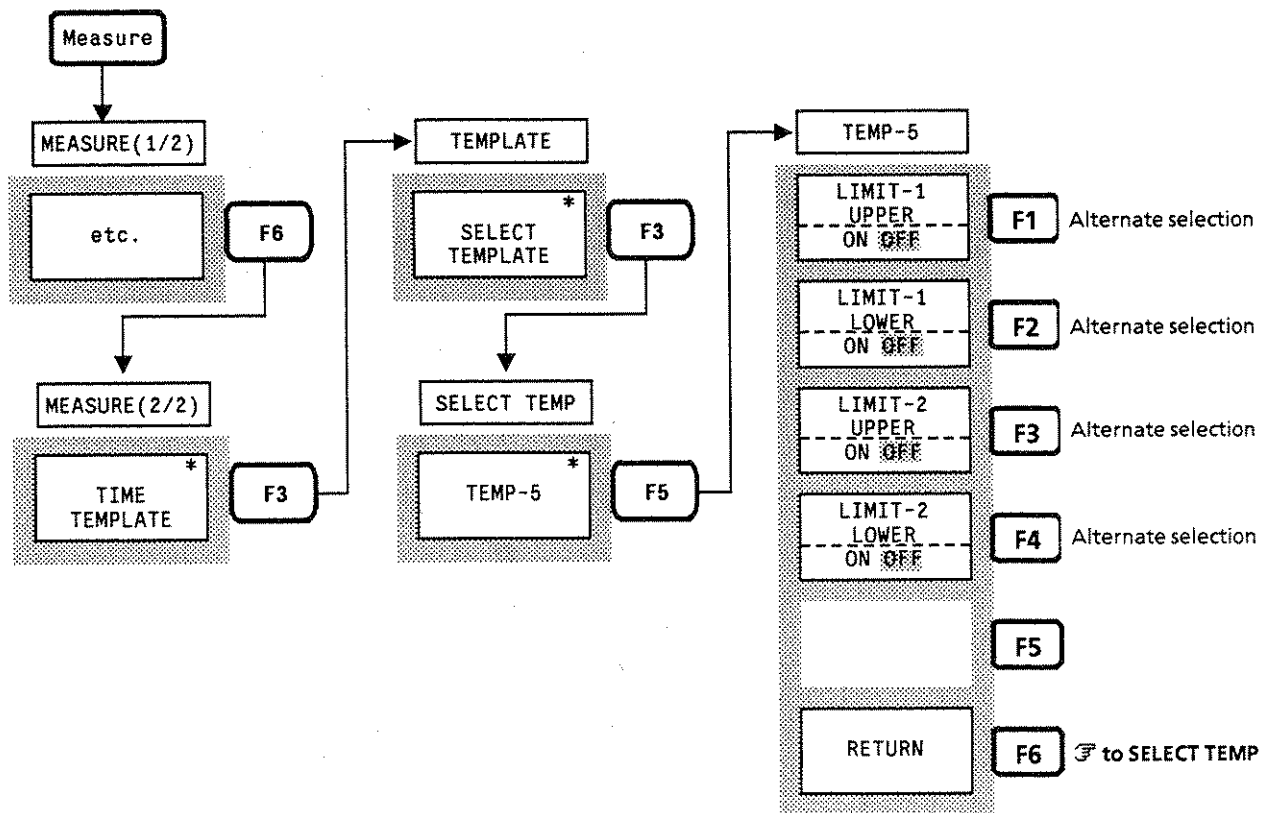

Sets delay time
Sets time span
Displays the menu for setting expand function. F to EXPAND MODE
Displays the menu for setting the storage or detection mode. F to STORAGE / DET
Displays the menu for selecting the waveform monitor function. F to MONITOR
Displays the menu for setting the display line function. F to DISPLAY LINE

- TIME
- DELAY TIME
- TIME SPAN
- EXPAND MODE *
- STORAGE/DET MODE *
- FM/TRIG MONITOR *
- DISPLAY LINE *

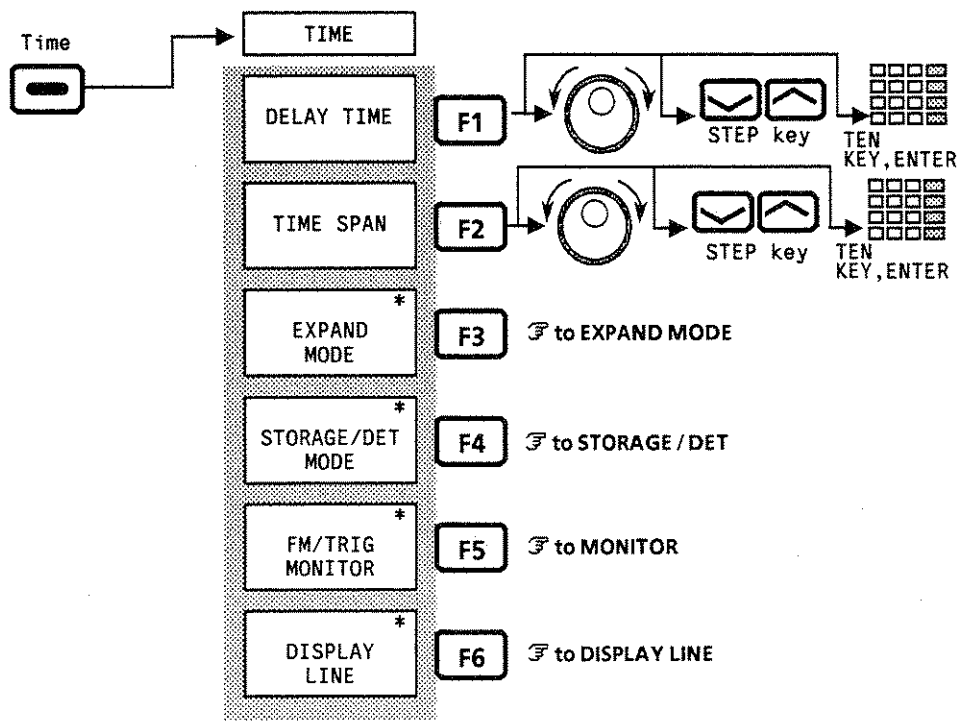

Select the title display from among OFF / ON / DATE.
Moves the cursor to the left
Moves the cursor to the right
Selects upper-case characters
Selects lower-case characters
Selects numeric or sign characters

TITLE
DISPLAY
OFF
CURSOR←
CURSOR→
ABC..Z
abc..z
0123..

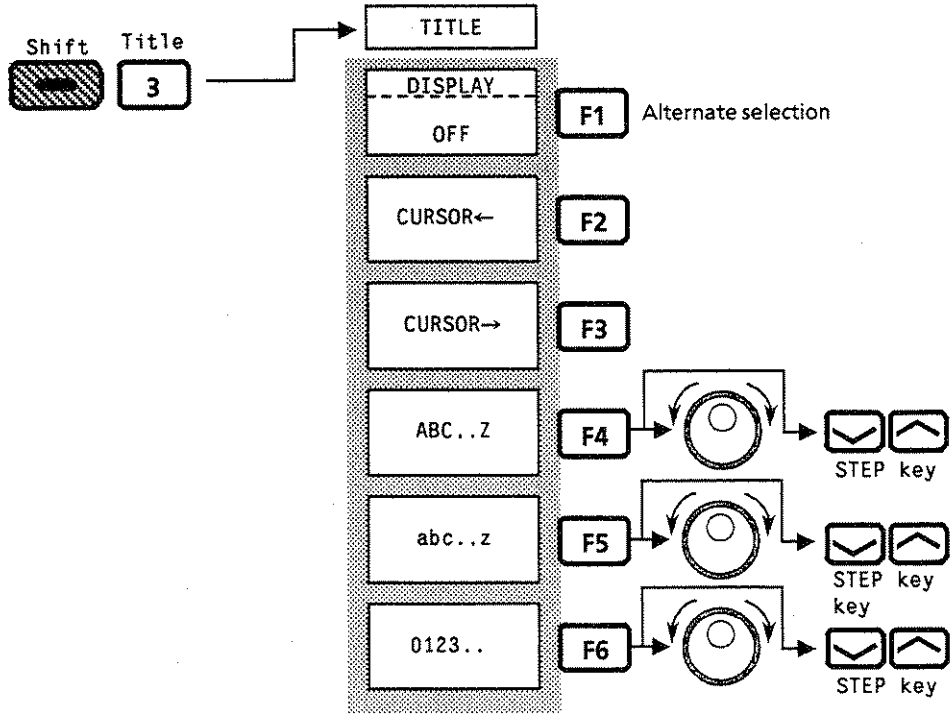

<p>Sets the trace A storage mode to NORMAL. NORMAL: Renews and displays trace data at each sweep. This is used for normal measurement.</p>
<p>Displays the menu for selecting the trace A storage mode from the MAX, MIN, and AVG parameters. ☞ to MAX / MIN / AVG</p>
<p>Displays the menu for selecting the trace A storage mode from CUMULATIVE or OVER WRITE. ☞ to CUM / OVER</p>
<p>Sets the trace A storage mode to VIEW. VIEW: Continues displaying the waveform as it is without refreshing the current trace data. This mode is used to observe the waveform with the trace data stopped.</p>
<p>Displays the menu for selecting the trace A detection mode. ☞ to DET MODE</p>
<p>Displays the menu for setting the display line. ☞ to DISPLAY LINE</p>

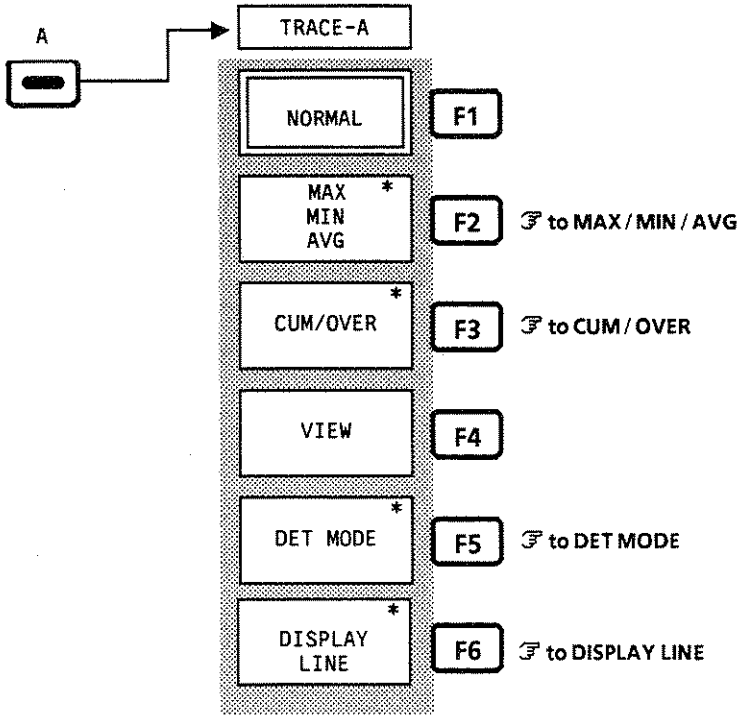
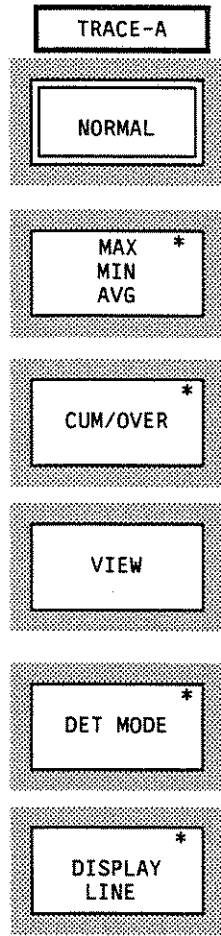

	TRACE-A/B
Displays trace A and trace B superimposed on each other	TRACE A & B
Displays trace A and trace B by separating them to the upper and lower sides	TRACE-A/ TRACE-B
Selects trace A or trace B for marker display	MARKER TRACE-A TRACE-B
No function	
Sets the trace B storage mode to WRITE	TRACE-B WRITE
Sets the trace B storage mode to VIEW	TRACE-B VIEW

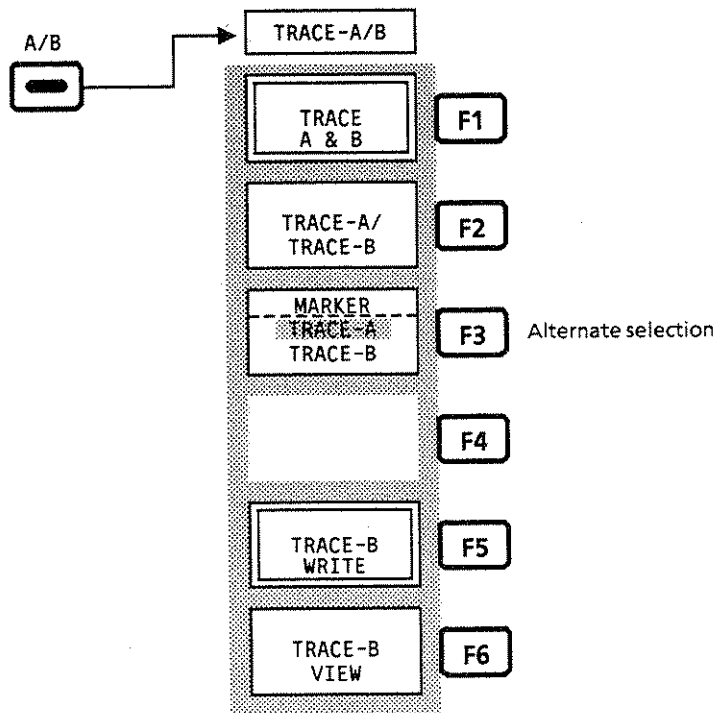

Sets the trace BG to main trace, and trace A to sub-trace
Sets the trace A to main trace, and trace BG to sub-trace
No function
No function
Sets the sub-trace storage mode to WRITE
Sets the sub-trace storage mode to VIEW

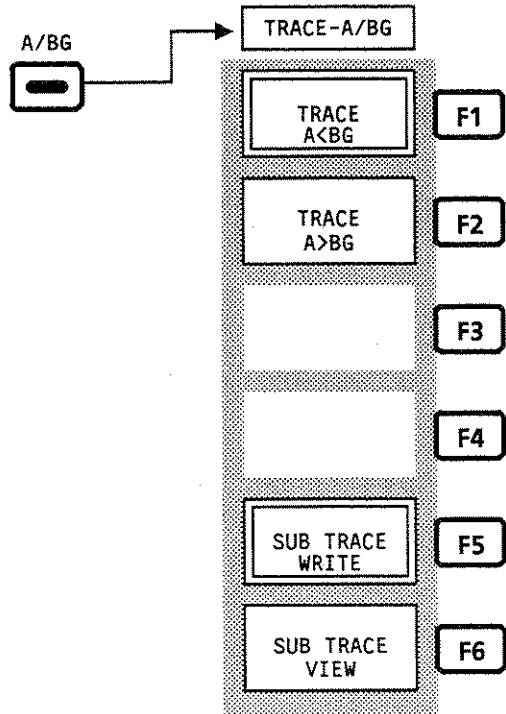
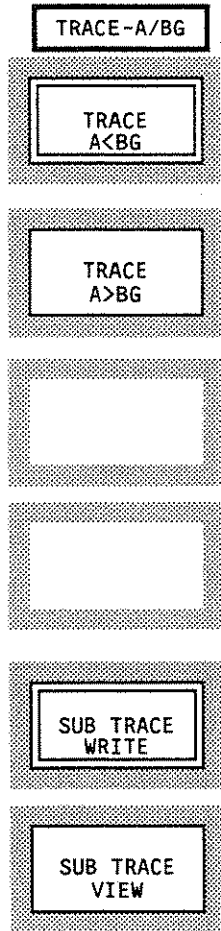

Sets the trace TIME to main trace, and trace A to sub-trace
Sets the trace A to main trace, and trace TIME to sub-trace
No function
No function
Sets the sub-trace storage mode to WRITE
Sets the sub-trace storage mode to VIEW

TRACE-A/TIME

TRACE
A<TIME

TRACE
A>TIME

SUB TRACE
WRITE

SUB TRACE
VIEW

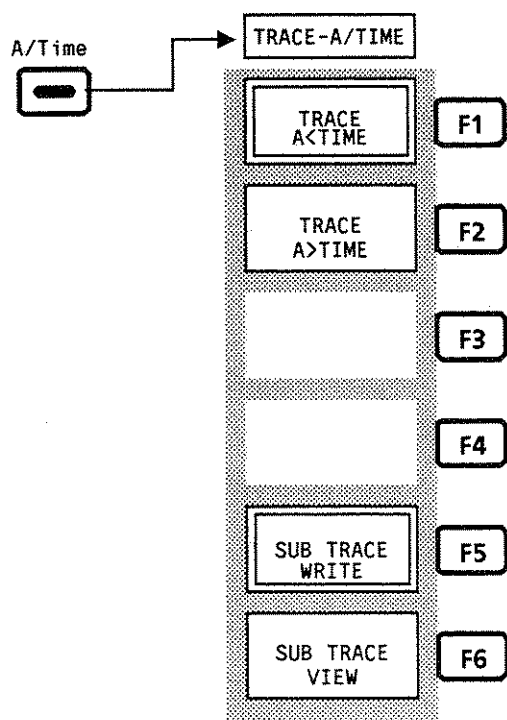

<p>Sets the trace B storage mode to NORMAL. NORMAL: Renews and displays trace data at each sweep. This is used for normal measurement.</p>
<p>Displays the menu for selecting the trace B storage mode from the MAX, MIN, and AVG parameters. ☞ to MAX / MIN / AVG</p>
<p>Displays the menu for selecting the trace B storage mode from CUMULATIVE or OVER WRITE. ☞ to CUM / OVER</p>
<p>Sets the trace B storage mode to VIEW. VIEW: Continues displaying the waveform as it is without refreshing the current trace data. This mode is used to observe the waveform with the trace data stopped.</p>
<p>Displays the menu for selecting the trace B detection mode. ☞ to DET MODE</p>
<p>Displays the menu for setting the display line function. ☞ to DISPLAY LINE</p>

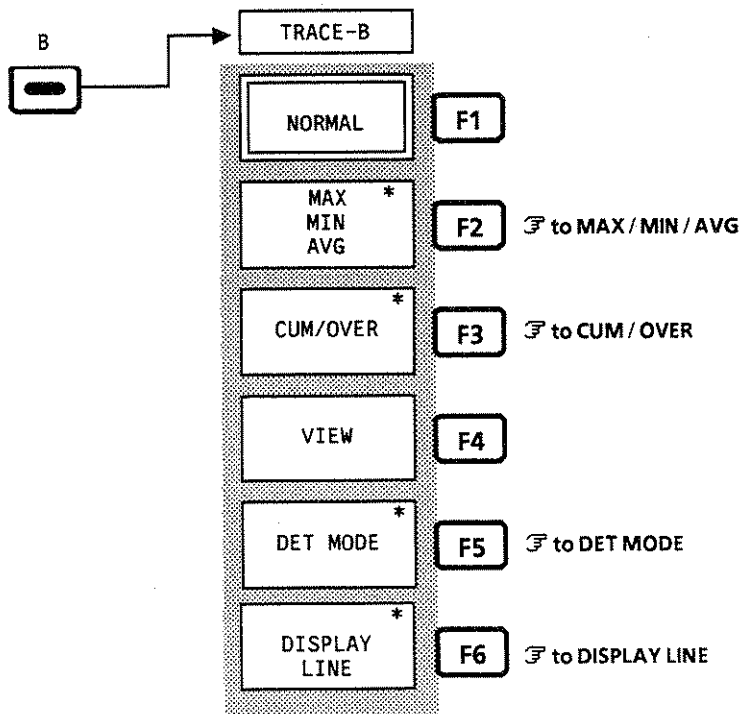
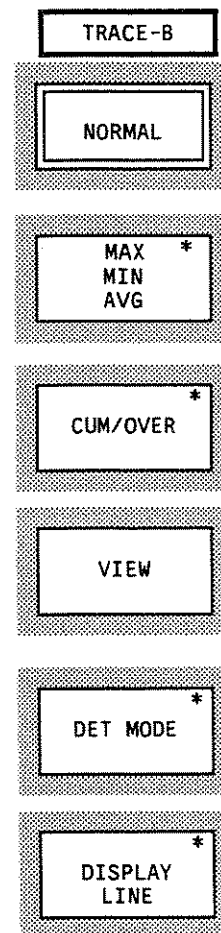

Displays the directory of the PMC or floppy disk	TRACE FILES
Deletes the specified file	DIR/NEXT
Write-protects (write-inhibit) the specified file	DELETE FILE No.
No function	WRITE PROTECTION FILE No.
No function	
Returns to the preceding menu. ↩ to DIRECTORY	RETURN

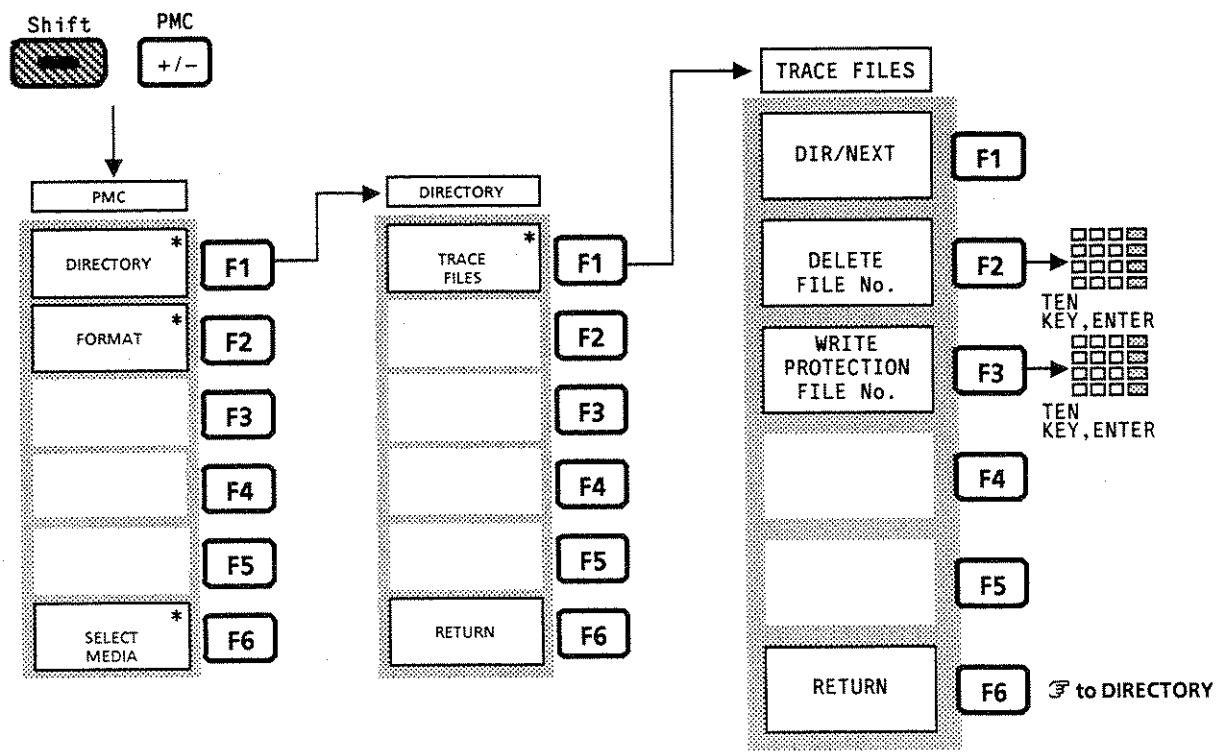

Selects the trigger mode for FREE RUN or TRIGGERED.
FREE RUN: When the sweep mode is set to Continuous, the continuous sweep is executed repeatedly each time the trigger conditions are met. The single sweep mode allows the single sweep to be started immediately after the Single key is pressed.
TRIGGERED: When the conditions of the pre-selected trigger source are met, the sweep can be started.

No function

Displays the menu for selecting the trigger source.
 ⌘ to TRIG SOURCE

No function

Sets the trigger level

Selects the trigger slope

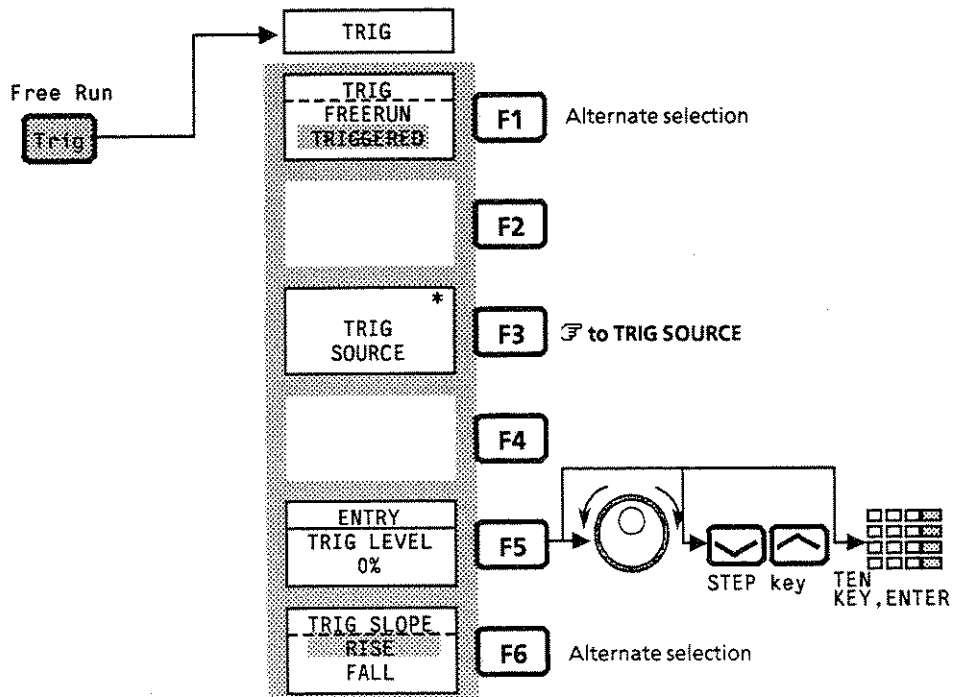
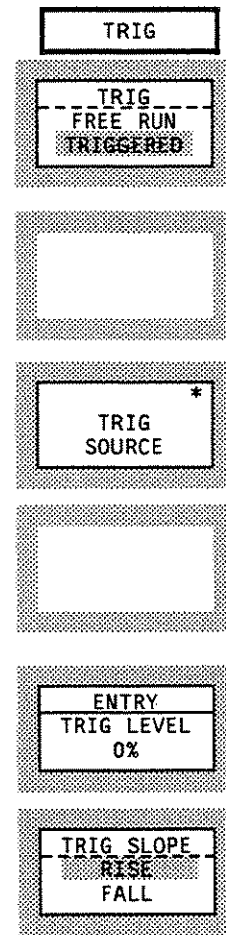

<p>Sets the trigger source to VIDEO. VIDEO: Starts the sweep in synchronism with the positive leading edge or negative leading edge of the waveform after detection.</p>
<p>Sets the trigger source to LINE. LINE: Starts the sweep in synchronism with the AC power line frequency. The line trigger is conveniently used to observe the power line-related hum waveform. The line trigger is used by selecting neither the trigger level nor trigger slope.</p>
<p>Sets the trigger source to external input. The sweep is started in synchronism with the positive leading edge or negative leading edge of the signal waveform input to the Ext Input connector on the rear panel. ☞ to EXT TRIG</p>
<p>Sets the trigger source to T. ☞ to TV TRIG</p>
No function
<p>Returns to the preceding menu. ☞ to TRIG</p>

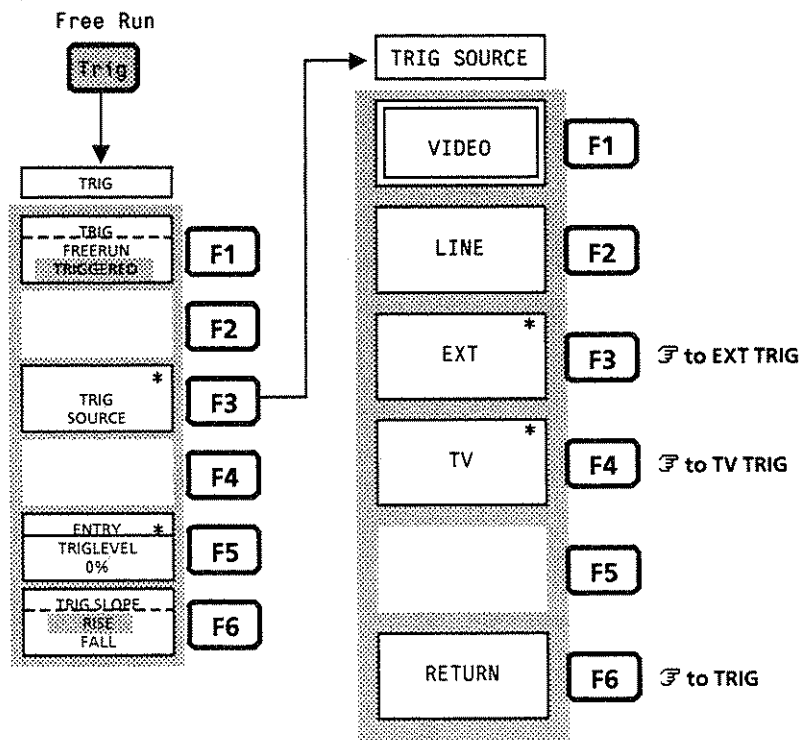
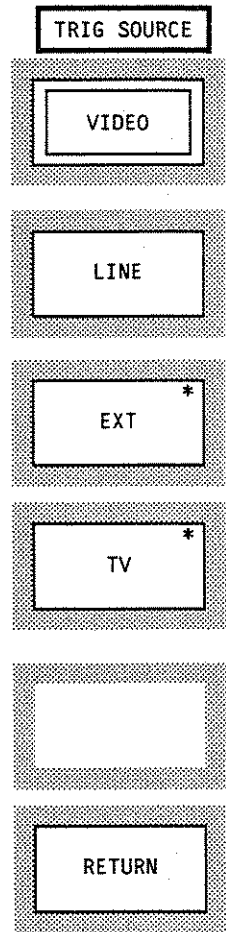

Selects the television signal system
Triggers with vertical synchronous signal
Triggers with horizontal synchronous signal (even field)
Triggers with horizontal synchronous signal (odd field)
Sets the line number of horizontal synchronous signal
Returns to the preceding menu. ↶ to TRIG SOURCE

TV TRIG

TV
NTSC
PAL

V-SYNC

H-SYNC
EVEN

H-SYNC
ODD

ENTRY
H-SYNC LINE
10

RETURN

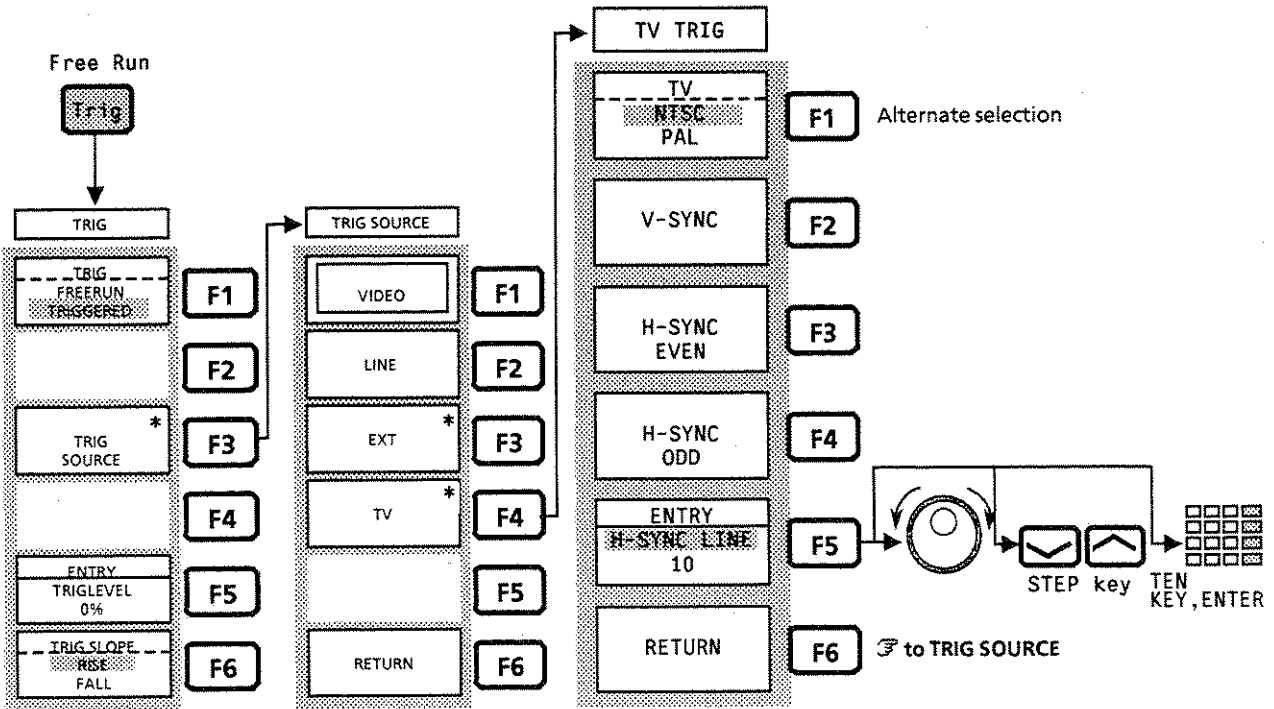

Indicates that the VBW function is set in MANUAL mode. Pressing this key in AUTO mode changes to MANUAL mode.
Indicates that the VBW function is set in AUTO mode. Pressing this key in MANUAL mode changes to AUTO mode.
Sets the VBW to OFF
Sets the ratio of VBW and RBW when VBW is set to AUTO
The manual RBW, VBW and Swp Time functions return to AUTO control
All the values of the coupled function return to AUTO control

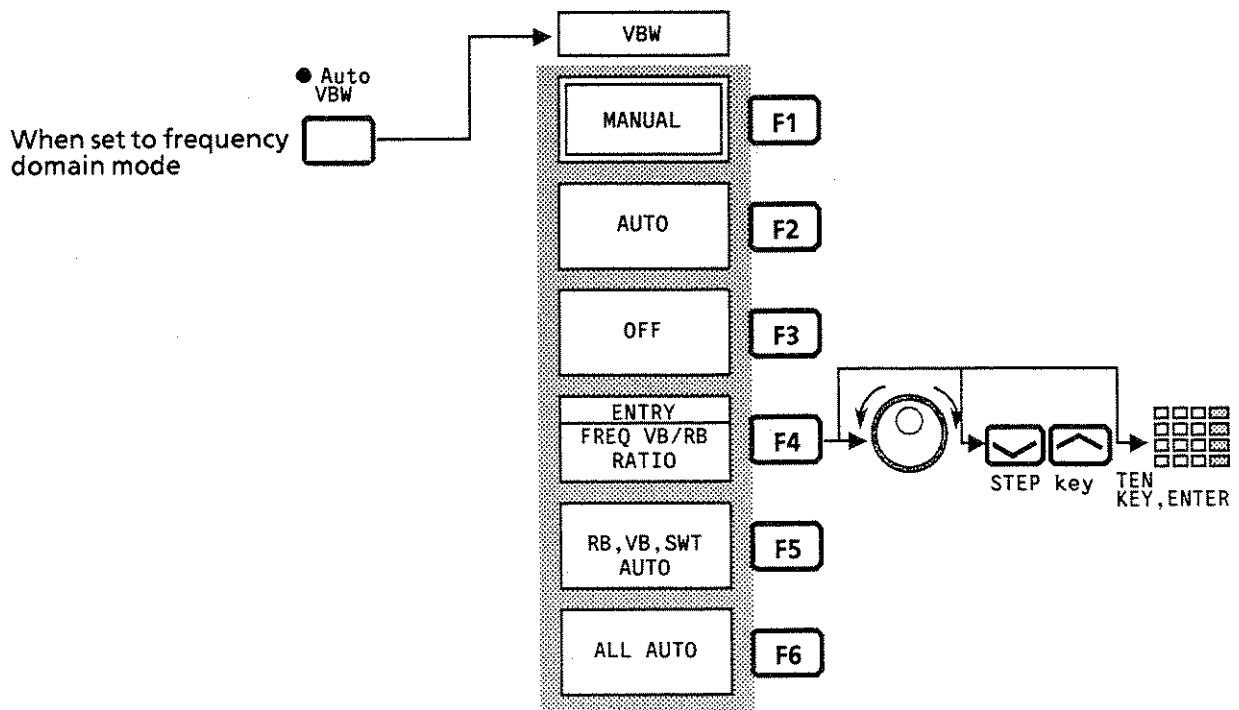
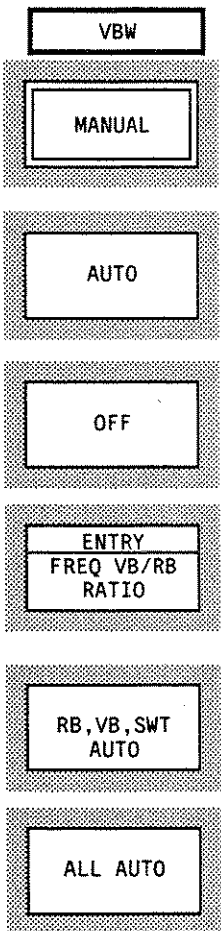

Indicates that the VBW function is set in MANUAL mode. Pressing this key in AUTO mode changes to MANUAL mode.
Indicates that the VBW function is set in AUTO mode. Pressing this key in MANUAL mode changes to AUTO mode.
Sets the VBW to OFF
Sets the ratio of VBW and RBW when VBW is set to AUTO
The manual RBW, VBW and Swp Time functions return to AUTO control
All the values of the coupled function return to AUTO control

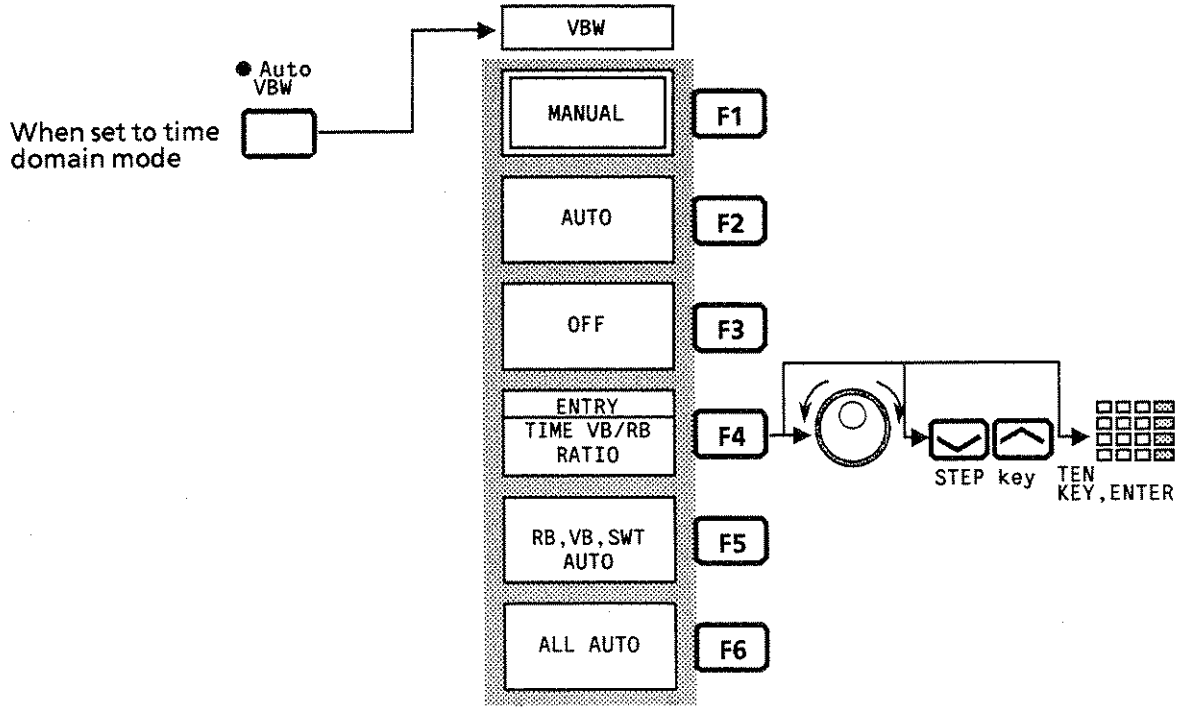
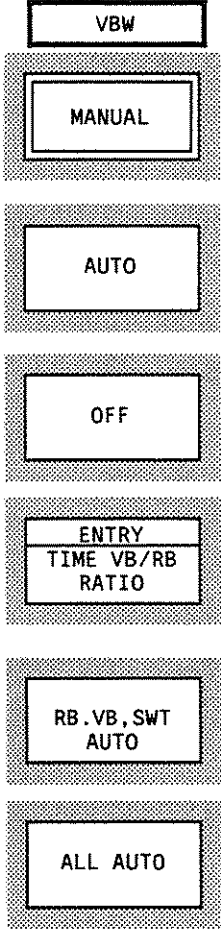

Sets the measure window in the upper right-hand corner on the graticule	<div style="border: 1px solid black; padding: 2px; text-align: right;">WINDOW POSN</div> <div style="border: 1px solid black; padding: 2px; text-align: right;">[#]</div>
Sets the measure window in the lower left-hand corner on the graticule	<div style="border: 1px solid black; padding: 2px;">[#]</div>
Sets the measure window in the lower center on the graticule	<div style="border: 1px solid black; padding: 2px; text-align: center;">[#]</div>
Sets the measure window in the lower right-hand corner on the graticule	<div style="border: 1px solid black; padding: 2px; text-align: right;">[#]</div>
No function	<div style="border: 1px solid black; padding: 2px;"></div>
Returns to the preceding menu. ↶ to MEASURE (1/2)	<div style="border: 1px solid black; padding: 2px; text-align: center;">RETURN</div>

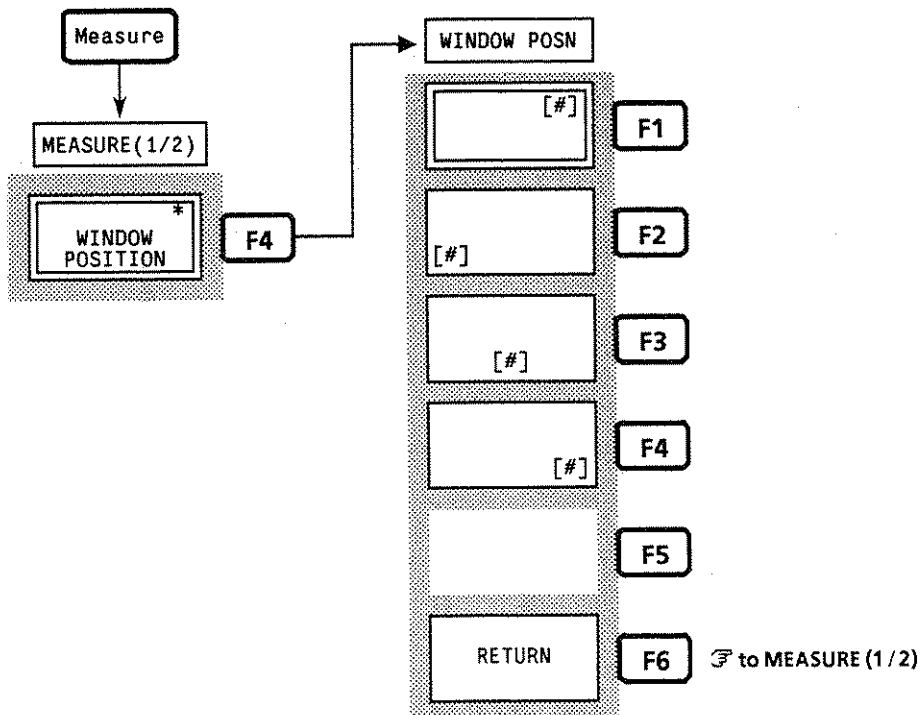

Sets the zone width to 1 point (SPOT)
Sets the zone width to 0.5 div
Sets the zone width to 1 div
Sets the zone width to 2 div
Sets the zone width to 5 div
Sets the zone width to 10 div

ZONE WIDTH

SPOT

0.5div

1div

2div

5div

10div

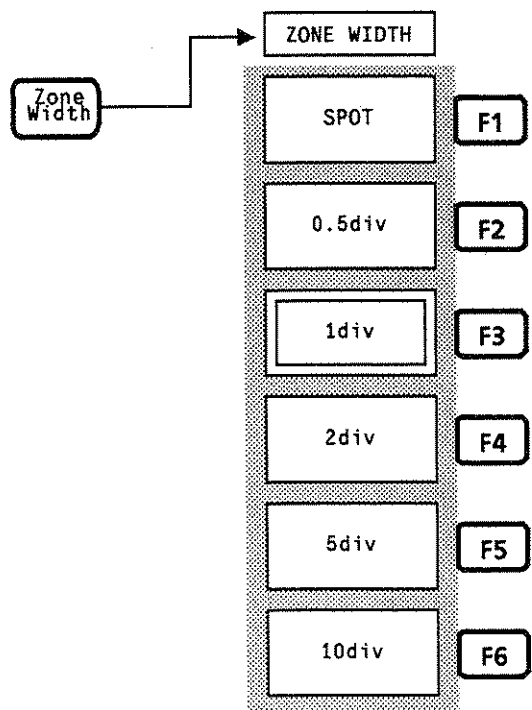

ZONE WIDTH

APPENDIXES

TABLE OF CONTENTS

APPENDIX A	MS2602A BLOCK DIAGRAM	A-1
APPENDIX B	LIST OF ABBREVIATIONS ON PANEL AND DISPLAY	B-1
APPENDIX C	CONNECTION TO UA-455A VIDEO PLOTTER	C-1
APPENDIX D	CONNECTING VP-1500II VIDEO PRINTER	D-1
APPENDIX E	HOW TO USE AN EXTERNAL DISPLAY	E-1
APPENDIX F	PANEL DESCRIPTION	F-1

(Blank)

APPENDIX A MS2602A BLOCK DIAGRAM

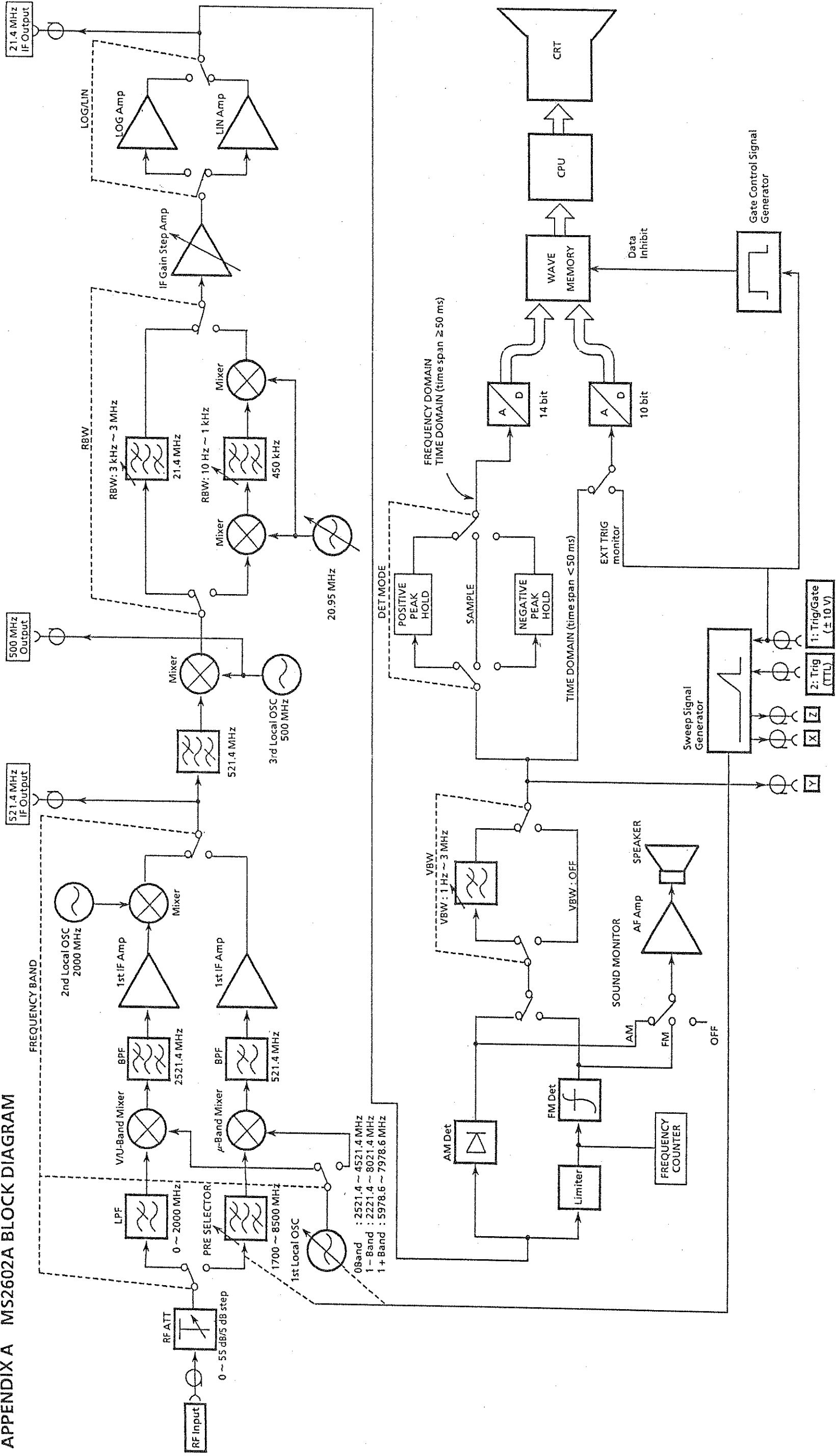

Fig. A-1 MS2602A Spectrum Analyzer Block Diagram

(Blank)

APPENDIX B

LIST OF ABBREVIATIONS ON PANEL AND DISPLAY

Abbreviations on the MS2602A panels and display screens are spelled out below in alphabetical order.

Abbreviation	Spelling (Meaning)	Abbreviation	Spelling (Meaning)
A	Trace-A	MAX	Maximum Hold
ABS	Absolute	MEAS	Measure
AC	Alternating Current	MIN	Minimum Hold
ADJ	Adjacent	MKR	Marker
AM	Amplitude Modulation	MON	Monitor
AMPL	Amplitude	NEG	Negative Peak Detection
AT	Input Attenuator	NTSC	National Television System Comittee
ATTEN	Input Attenuator	OBW	Occupied Bandwidth
AVG	Average	OVER	Over Write
B	Trace-B	PMC	Plug-in Memory Card
BG	Trace-BG(Back Ground)	PAL	Phase Alternation by Line Television System
BS	Back Space	POS	Positive Peak Detection
BW	Bandwidth	POSN	Position
CAL	Calibration	PRMTR	Parameter
CALC	Calculation	PTA	Personal Test Automation
CE	Clear Entry	PTR	Printer
CF	Center Frequency	PLTR	Plotter
CH	Channel	RB	Resolution Bandwidth
C/N	Carrier to Noise Ratio	RBt	Resolution Bandwidth (Time Domain)
CONT	Control	RBW	Resolution Bandwidth
CORR	Correction Data	REF	Reference Level
CTR	Center Frequency	REL	Relative
CUM	Cumulative	RES	Resolution
DC	Direct Current	RLV	Reference Level
DET	Detection Mode	SC	Scale
DIR	Directory	SGL	Single (Sweep)
DIV	Division	SMP	Sample Detection
EXP	Expand	ST	Sweep Time
EXT	External	STBY	Standby
FD	Floppy Disk	SWP	Sweep
FM	Frequency Modulation	SWT	Sweep Time
FREQ	Frequency	T	Trace-Time
GPIB	General Purpose Interface Bus	TEMP	Template
GP-GL	Graphtec Plotter Graphics Language	TIME	Trace-Time
HP-GL	Hewlett Packard Graphics Language	TR	Trace
H-SYNC	Horizontal Synchronizing Signal	TRC	Trace
INIT	Initiate	TRIG	Trigger
INT	Internal	TRKG	Tracking
LIN	Linear	TV	Television
LOG	Logarithmic	VB	Video Bandwidth
LVL	Level	VBt	Video Bandwidth (Time Domain)
		VBW	Video Bandwidth
		V-SYNC	Vertical Synchronizing Signal

(Blank)

APPENDIX C

CONNECTION TO UA-455A VIDEO PLOTTER

When connecting the UA-455A Video Plotter to the MS2602A to hard-copy the screen, select the connection cable as described below and set the UA-455A rear-panel switches and volume.

■ Connection cable

A DIN-8P cable (1 m) is used as the connection cable. This cable is supplied as an accessory with the UA-455A.

■ Switch and volume settings

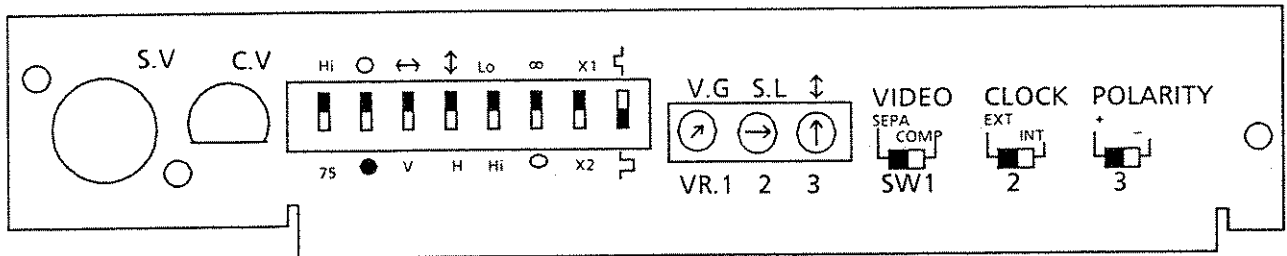

CAUTION

Before supplying power to the UA-455A, confirm that the AC line voltage is the specified value (**Vac). If the AC line voltage is inappropriate, there is a risk of damage to the internal circuits by the abnormal voltage.

- Notes:**
- Set the switches to the black side.
 - The volume setting position is shown at the typical position.
 - For fine adjustment, refer to the UA-455A Operation Manual.

(Blank)

APPENDIX D

CONNECTING VP-1500 II VIDEO PRINTER

To capture hard copies of screens when MS2602A is connected to the VP-1500 II Video Printer (Seikosha Corp.), you must use the cable listed below, and then set the proper mode for the printer.

■ Connection cable

Use the CBL-15GC cable (for separate video signals from measurement equipment).

■ Mode settings

See the table below.

- Notes:**
- *For details on the VP-1500 II , contact Seikosha Corp.*
 - *Examples are provided for the settings for each mode.*
 - *For further information, including the typical settings of modes, refer to the "VP-1500 II Operation Manual".*

Mode No.	Name	Code	Description	Setting
01	Initial setting	0100X	0: Off	0
02	Signal type	020XX	02: SEPA	02
03	Scanning method	0300X	1: Non-interlace	1
04	Sampling clock	0400X	1: External clock	1
05	Internal clock frequency	05XXX	10.0 to 40.0 MHz	21.5
06	External clock phase	060XX	00 to 31	03
07	Print direction	0700X	2: SIDE	2
08	Resolution	0800X	0: Normal	0
09	Black and white inversion	0900X	0: Normal	0
10	Horizontal trimming	10XXX	000 to 255, unit: 8 dots \div 1.33 mm	005
11	Vertical trimming	11XXX	000 to 255 raster	015
12	Video amplification	12XXX	000 to 166 mm (normal)	113
13	Image height	13XXX	000 to 999 raster (normal)	450
14	Length of recording charts	14XXX	400 mm or less	096
15	Top margin	150XX	00 to 60 mm	16
16	Left margin	160XX	00 to 60 mm	20
17	Gain	17XYY	X=0: Auto	050
18	Auto gain area	1800X	0: No area setting	0
19	Area specification	19XYZ		000
20	Pedestal	20XYY	X=0: Auto	017
21	Color bar filter	2100X	0: No filter	0
22	Sharpness	2200X	0: None	0
23	Gradations	2300X	0: 64 levels	0
24	Noise reducer	2400X	0: Off	0
25	Noise reduction	2500X	1: NR(I)	1
26	Phase adjustment	260XX	00 to 31 (when separate)	00
27	Even-odd adjustment	27XYY	X: Rough 0 or 1 YY: Fine 00 to 31	000
28	Edge switching (H)	2800X	0: Negative logic	0
29	Edge switching (V)	2900X	0: Negative logic	0

D-2.

APPENDIX E

HOW TO USE AN EXTERNAL DISPLAY

The MS2602A rear panel has a digital RGB output connector for outputting screen information to an external display.

If this is connected to a color monitor with the RGB input terminal, the MS2602A screen information can be displayed in six colors as shown below.

Scale	Red
Marker	Purple
Text data	Pale blue
Trace A	White
Trace B, BG, TIME	Yellow
PTA screen	Green

The following shows the pinout configuration of the digital RGB output connector and the signal output timing chart.

■ Pinout configuration

Connector D - sub 9 pins

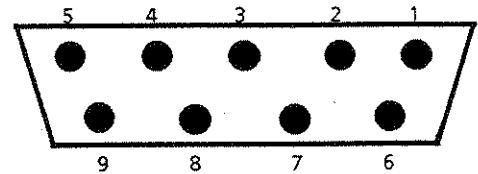

Pin No.	Signal output	Specifications
1	Ground	—————
2	Ground	—————
3	Red video signal output	TTL level, positive polarity
4	Green video signal output	TTL level, positive polarity
5	Blue video signal output	TTL level, positive polarity
6	Intensity signal output	TTL level, positive polarity (fixed to LOW level)
7	Ground	—————
8	Horizontal synchronization signal	TTL level, positive polarity
9	Vertical synchronization signal	TTL level, positive polarity

■ Timing chart

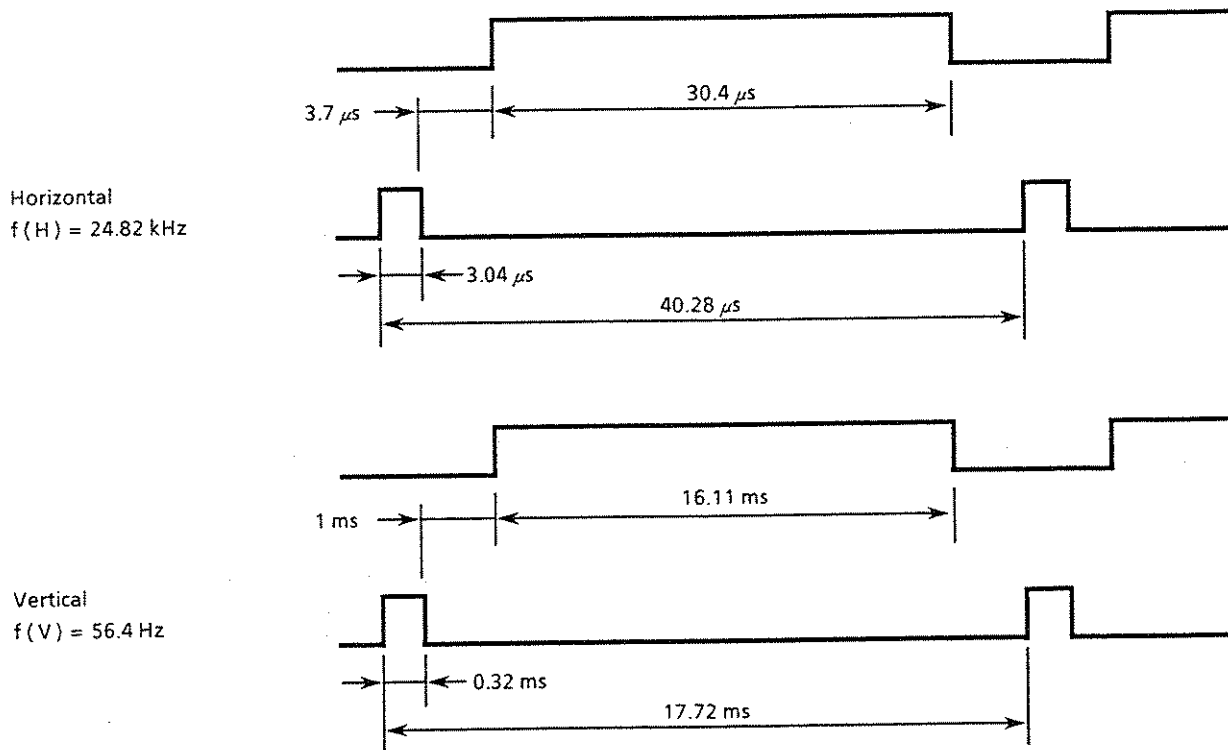

■ Recommended color monitor

JUM - 1482AN (Mitsubishi Electric)
CMT - A15HM (Sanyo Electric)

■ Connection Cable

Use a connection cable that matches the shape and number of pins of the connector on your color monitor.

In addition, the cable you use should be shielded to prevent electromagnetic interference (EMI).

APPENDIX F

PANEL DESCRIPTION

This appendix describes the panel description with the following tables and figures.

TABLE OF CONTENTS

Table F-1	How to Read the Soft Key Menu
Table F-2	Soft Key List
Fig. F-1	Front Panel
Fig. F-2	Rear Panel

(Blank)

Table F-1 How to Read the Soft Key Menu

The following explains how to read the F1 to F6 Function Soft key menu listed in Table F-2. The menu is called by pressing a panel key.

Types of soft keys	Explanation
<p>Child menu key</p> <p>< e.g. ></p> <div style="border: 1px solid black; padding: 2px; display: inline-block;">START/SPAN</div> <p style="text-align: center;">*</p>	<p>Where there is a '*' mark in the upper-right corner within the menu frame, each time the soft key with this asterisk is pressed, the child function menus are displayed for more detailed menus.</p>
<p>Data entry key</p> <p>< e.g. ></p> <div style="border: 1px solid black; padding: 2px; display: inline-block;">START FREQ</div> <div style="text-align: center; margin-top: 10px;"> </div>	<p>The soft key which has the same label name as the entry item name in the communication field. While the communication field is displayed, enter the data using the TEN keys or rotary knob.</p> <p style="text-align: center;">← Communication field</p> <p style="text-align: center;">START FREQ = 0Hz</p> <p>Press the desired data entry key to change the entry item in the communication field or to display the communication field if it is not displayed.</p>
<p>Direct data entry key with double frame</p> <p>< e.g. ></p> <div style="border: 3px double black; padding: 2px; display: inline-block;">2d1v</div>	<p>Directly selects the data labelled in the frame, and not via the communication field. This soft key is displayed with a single frame before it is pressed. Once it has been pressed, the key is displayed with a double frame to show that the data inside the frame has been selected.</p>
<p>Data entry key with ENTRY frame</p> <p>< e.g. ></p> <div style="border: 1px solid black; padding: 2px; display: inline-block;">ENTRY</div> <div style="border: 1px solid black; padding: 2px; display: inline-block;">AVERAGE</div> <div style="border: 1px solid black; padding: 2px; display: inline-block;">8</div>	<p>The soft key with a frame labelled ENTRY. Pressing this key highlights the ENTRY frame. This signifies that data can be entered in the communication field using the TEN keys or rotary knob.</p>
<p>Alternate/Scroll-selection key</p> <p>< e.g. ></p> <div style="border: 1px solid black; padding: 2px; display: inline-block;">COUPLING</div> <div style="border: 1px solid black; padding: 2px; display: inline-block;">AC</div> <div style="border: 1px solid black; padding: 2px; display: inline-block;">DC</div>	<p>Alternately selects two kinds of data below the dotted line border. If there is only one kind of data between the brackets < >, one or more data items are scrolled for selection each time the soft key is pressed.</p>

☆ The operation child menu is classified into three different styles as follows:

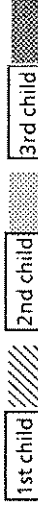





☆ The details of the menu for the Measure function is shown by the operation flowchart regardless of the classification.

Table F-2 Soft Key List (1 / 9)

Freq / Ampl		Function setting by soft key					
Frequency		Span		Panel section name		Panel key name	
Frequency	Span	F4	F2	F1	F2	Key operation	Menu classification
FREQ 1/2	SPAN	START/SPAN	FINE ADJ	SCROLL STEP	FINE ADJ	Span	Span
CENTER FREQ	FULL SPAN	START FREQ	FINE ADJ ON OFF	1d1v	ON OFF	FULL SPAN	F1
START FREQ	ZERO SPAN	FREQ SPAN	ADJ -1.5kHz	2d1v	ADJ -1.5kHz	ZERO SPAN	F2
STOP FREQ	AUTO BAND	etc.	etc.	5d1v	etc.	AUTO BAND	F3
START/SPAN *	MANUAL BAND 0 0-2GHz	etc.	etc.	10d1v	etc.	MANUAL BAND 0 0-2GHz	F4
CF STEP SIZE	MANUAL BAND 1- 1.7-7.5GHz	0 to 8500MHz	0 to 8500MHz	RETURN	RETURN	MANUAL BAND 1- 1.7-7.5GHz	F5
etc.	MANUAL BAND 1+ 6.5-8.5GHz	0 to 8500MHz	-50 to 50kHz	etc.	etc.	MANUAL BAND 1+ 6.5-8.5GHz	F6
0 to 8500MHz	0 to 8500MHz	0 to 8500MHz	0 to 8500MHz	0 to 8500MHz	0 to 8500MHz	0 to 8500MHz	Data knob selection
0 to 8500MHz	0 to 8500MHz	0 to 8500MHz	0 to 8500MHz	0 to 8500MHz	0 to 8500MHz	0 to 8500MHz	Scroll selection

☆ First press the panel keys in the ← key operation row. Press these keys including the [Shift] key etc. in the left to right direction.
 ☆ The menu is then displayed. Select the function corresponding to the [F1] to [F6] soft keys in the rightmost column.
 ☆ The soft key with the double frame indicates the settings when initialized.
 (The coupled function is set to MANUAL because of the panel key operation.)

Table F-2 Soft Key List (4 / 9)

Display		Panel section name						
		Panel key name						
		Function setting by soft key						
		Menu classification						
		Key operation						
A	 TRACE-A NORMAL * MAX MIN AVG * CUM/OVER VIEW DET MODE * DISPLAY LINE	F2	MAX/MIN/AVG	MAX HOLD	MIN HOLD	AVERAGE	ENTRY AVERAGE 8	RETURN
		F3	CUM/OVER	CUMULATIVE	OVERWRITE			RETURN
B	 TRACE-B NORMAL * MAX MIN AVG * CUM/OVER VIEW DET MODE * DISPLAY LINE	F2	MAX/MIN/AVG	MAX HOLD	MIN HOLD	AVERAGE	ENTRY AVERAGE 8	RETURN
		F3	CUM/OVER	CUMULATIVE	OVERWRITE			RETURN
A	 TRACE-A NORMAL * MAX MIN AVG * CUM/OVER VIEW DET MODE * DISPLAY LINE	F5	DET MODE	POS PEAK	SAMPLE	NEG PEAK		RETURN
		F6	DISPLAY LINE	LINE ON OFF	ENTRY LINE LEVEL -50.00dBm	MKR LEVEL ABS REL		RETURN
B	 TRACE-B NORMAL * MAX MIN AVG * CUM/OVER VIEW DET MODE * DISPLAY LINE	F5	DET MODE	POS PEAK	SAMPLE	NEG PEAK		RETURN
		F6	DISPLAY LINE	LINE ON OFF	ENTRY LINE LEVEL -50.00dBm	MKR LEVEL ABS REL		RETURN
		F1	● Scroll selection					
		F2	● Data knob selection					
		F3						
		F4						
		F5						
		F6						

☆ The operation child menu is classified into three different styles as follows:

- 1st child 
- 2nd child 
- 3rd child 

☆ The details of the menu for the Measure function is shown by the operation flowchart regardless of the classification.

- ☆ First press the panel keys in the ←key operation row. Press these keys including the [Shift] key etc. in the left to right direction.
- ☆ The menu is then displayed. Select the function corresponding to the [F1] to [F6] soft keys in the rightmost column.
- ☆ The soft key with the double frame indicates the settings when initialized. (The coupled function is set to MANUAL because of the panel key operation.)

Table F-2 Soft Key List (5 / 9)

Display					Time			A/B			A/BG			A/Time			Panel section name																														
																	Panel key name																														
TIME					EXPAND MODE F3			STORAGE/DET F4			MAX./MIN./AVG F4 F2			CUM./OVER F4 F3			DET MODE F4 F5			MONITOR F5			FM F5 F1			DISPLAY LINE F6			A/B			A/BG			A/Time			Panel key name									
TIME					EXPAND MODE			STORAGE/DET			MAX./MIN./AVG			CUM./OVER			DET MODE			MONITOR			FM			DISPLAY LINE			TRACE-A/B			TRACE-A/BG			TRACE-A/Time			Panel key name									
DELAY TIME					ZONE START			NORMAL			MAX HOLD			CUMULATIVE			POS PEAK			FM MONITOR			200kHz/div (BW<1MHz)			LINE ON/OFF			TRACE A & B			TRACE A < BG			TRACE A < TIME			F1									
TIME SPAN					ZONE SPAN			MAX MIN AVG			MIN HOLD			OVERWRITE			SAMPLE			EXT TRIG MONITOR			20kHz/div (BW<50kHz)			LINE LEVEL -50.00dBm			TRACE A / TRACE-B			TRACE A > BG			TRACE A > TIME			F2									
EXPAND MODE					ZONE ON/OFF			CUM./OVER			AVERAGE			NEG PEAK			OFF			MKR LEVEL ABS REL															F3												
STORAGE/DET MODE					EXPAND ON/OFF			VIEW			ENTRY AVERAGE 8						RETURN																		F4												
FM/TRIG MONITOR								DET MODE									RETURN																					F5									
DISPLAY LINE					RETURN			RETURN			RETURN			RETURN			RETURN			RETURN			RETURN			COUPLING AC DC			TRACE-B WRITE			SUB TRACE WRITE			SUB TRACE VIEW			F6									
-1000 sec to 65.5 msec					-1000 sec to 65.5 msec																																				F1						
50µ to 1000 sec					50µ to 1000 sec																																				F2						
								2 to 1024																																	F3						
																																												F4			
																																															F5
																																															F6

☆ The operation child menu is classified into three different styles as follows:

- 1st child
- 2nd child
- 3rd child

☆ The details of the menu for the Measure function is shown by the operation flowchart regardless of the classification.

- ☆ First press the panel keys in the ←-key operation row. Press these keys including the [Shift] key etc. in the left to right direction.
- ☆ The menu is then displayed. Select the function corresponding to the [F1] to [F6] soft keys in the rightmost column.
- ☆ The soft key with the double frame indicates the settings when initialized.
(The coupled function is set to MANUAL because of the panel key operation.)

Table F-2 Soft Key List (6 / 9)

Sweep Control				Coupled Function				Panel section name
Gate	Trig			RBW	VBW	Swp Time	Atten	Panel key name
Gate	Free Run	TRIG SOURCE	EXT TRIG	Auto RBW	Auto VBW	Auto Swp Time	Auto Atten	Key operation
GATE	TRIG	VIDEO	INPUT 1 (±10V)	RBW	(At time domain) VBW	(At time domain) SWP TIME	ATTEN	Menu classification
GATE ON OFF	TRIG FREE RUN TRIGGER	LINE	INPUT 2 (TTL)	MANUAL	MANUAL	TIME SPAN	MANUAL	F1
ENTRY GATE DELAY 0.µs		* EXT		AUTO	AUTO		AUTO	F2
ENTRY GATE LENGTH 1.000ms	* TRIG SOURCE	TV		OFF	OFF			F3
GATE END INT EXT		* TV		ENTRY FREQ VB/RB RATIO	ENTRY TIME VB/RB RATIO			F4
	ENTRY TRIG LEVEL 0%	RETURN	RETURN	RB, VB, SWT AUTO	RB, VB, SWT AUTO		ALL AUTO	F5
	TRIG SLOPE RISE FALL			ALL AUTO	ALL AUTO		ALL AUTO	F6
		NTSC EVEN: 9 to 262 NTSC ODD: 10 to 263 PAL EVEN: 5 to 310 PAL ODD: 6 to 310		10 Hz to 3 MHz	1 Hz to 3 MHz	20 m to 1000 sec	0 to 55 dB	Function setting by soft key
0 to 65.5 msec	-100 to +100% (Trig source: at VIDEO) -10 to +10 V (Trig source: at EXT)							F1
20µ to 65.5 msec								F2
								F3
								F4
								F5
								F6

☆ The operation child menu is classified into three different styles as follows:

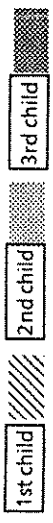

☆ The details of the menu for the Measure function is shown by the operation flowchart regardless of the classification.

☆ First press the panel keys in the ← key operation row. Press these keys including the [Shift] key etc. in the left to right direction.
 ☆ The menu is then displayed. Select the function corresponding to the [F1] to [F6] soft keys in the rightmost column.
 ☆ The soft key with the double frame indicates the settings when initialized.
 (The coupled function is set to MANUAL because of the panel key operation.)

Table F-2 Soft Key List (7/9)



































































































Measure & Save				Copy Cont				Function setting by soft key								
Recall		Save		Copy Cont		Setup PTR		Setup PLTR		Paper Size		Location		Item		
Panel section name		Panel key name		Panel key name		Panel key name		Panel key name		Panel key name		Panel key name		Panel key name		
Save Recall	← F5	→ F5 F5	← F5	→ F5 F5	← F3	→ F3 F2	← F2	→ F3	← F3	→ F3 F2	← F3	→ F3 F3	← F3 F4	→ F4		
RECALL	PMC	SELECT MEDIA	PMC	SELECT MEDIA	COPY CONT	PAPER SIZE	SETUP PTR	SETUP PLTR	DEVICE PRINTER PLOTTER	PAPER SIZE	LOCATION	ITEM	ALL			
MEMORY No.	FILE No.	INT PMC	SAVE FILE No.	INT PMC	DEVICE PRINTER PLOTTER	PAPER SIZE	HP2225	PLOTTER HP-GI GP-GI		[1] AUTO [2] [3] [4]						
MEM DIR	DIR/NEXT	EXT PMC1	DIR/NEXT	EXT PMC1	* SETUP PRINTER	FULL SIZE	EPSON VP-800	* PAPER SIZE		[#]			TRACE			
		EXT PMC2	DELETE FILE No.	EXT PMC2	* SETUP PLOTTER	QUARTER SIZE	UA455A	* LOCATION		[#]			SCALE			
		EXT FD	WRITE PROTECTION FILE No.	EXT FD	PRESET PLOT LOCATION		MC8104A	* ITEM		[#]						
		* SELECT MEDIA	* SELECT MEDIA	* SELECT MEDIA			ENTRY PRINTER ADDRESS: 17	ENTRY PLOTTER ADDRESS: 18		[#]						
		RETURN	RETURN	RETURN			RETURN	RETURN					RETURN			
1 to 16	1 to 99	1 to 16	1 to 16	1 to 99												



☆ The operation child menu is classified into three different styles as follows:
 1st child
 2nd child
 3rd child

☆ The details of the menu for the Measure function is shown by the operation flowchart regardless of the classification.

☆ First press the panel keys in the ← key operation row. Press these keys including the [Shift] key etc. in the left to right direction.
 ☆ The menu is then displayed. Select the function corresponding to the [F1] to [F6] soft keys in the rightmost column.
 ☆ The soft key with the double frame indicates the settings when initialized.
 (The coupled function is set to MANUAL because of the panel key operation.)

Table F-2 Soft Key List (8/9)

Panel section name		GP-IB						Function setting by soft key																						
Panel key name		← Key operation		← Menu classification																										
Cal	  0	 PRESEL TUNE	 GP-IB	 RS232C	 BAUD RATE1	 BAUD RATE2	 PARITY	 STOP BIT	 1bit	 1.5bit	 2bit	 etc.	 etc.	 RETURN	 F1															
																 CAL	 PRESEL TUNE	 GP-IB	 RS232C	 BAUD RATE1	 BAUD RATE2	 PARITY	 STOP BIT	 1bit	 1.5bit	 2bit	 etc.	 etc.	 RETURN	 F1
																 ALL	 AUTO TUNE	 ENTRY PORT1 MY ADDRESS:1	 * BAUD RATE	 9600	 600	 EVEN	 1bit	 1.5bit	 1.5bit	 2bit	 etc.	 etc.	 RETURN	 F2
																 LEVEL	 ENTRY MANUAL 0	 ENTRY PORT2 MY ADDRESS:16	 * PARITY	 4800	 300	 ODD	 1.5bit	 1.5bit	 1.5bit	 2bit	 etc.	 etc.	 RETURN	 F3
																 FREQ	 PRESET	 ENTRY MC8104A ADDRESS:19	 DATA BIT 7bit 5bit	 2400	 etc.	 OFF	 2bit	 2bit	 2bit	 etc.	 etc.	 etc.	 RETURN	 F4
 * PRESEL TUNE	 RETURN	 * RS232C (OPTION02)	 STOP BIT	 1200	 etc.	 RETURN	 RETURN	 RETURN	 RETURN	 RETURN	 RETURN	 RETURN	 RETURN	 F5																
															 F1															
															 F2															
															 F3															
															 F4															
															 F5															
															 F6															
															 Data knob selection															
															 Scroll selection															

☆ The operation child menu is classified into three different styles as follows:
 1st child  2nd child  3rd child 

☆ The details of the menu for the Measure function is shown by the operation flowchart regardless of the classification.
 ☆ First press the panel keys in the ← key operation row. Press these keys including the [Shift] key etc. in the left to right direction.
 ☆ The menu is then displayed. Select the function corresponding to the [F1] to [F6] soft keys in the rightmost column.
 ☆ The soft key with the double frame indicates the settings when initialized.
 ☆ (The coupled function is set to MANUAL because of the panel key operation.)

Measure

MEASURE (1/2)
* FREQ MEAS
* NOISE MEAS
* WINDOW POSITION
OFF
etc.

F1

F2

F3

F4

F5

F6

FREQ MEAS
COUNT ON
OFF
* SETUP
RETURN

RESOLUTION
1kHz
100Hz
10Hz
1Hz
RETURN

NOISE MEAS
ON
OFF
NOISE ABSOLUTE C/N RATIO
RETURN

WINDOW POSN
[#]
[#]
[#]
[#]
RETURN

MEASURE (2/2)
* OBW MEAS
* ADJ CH MEAS
* TIME TEMPLATE
* BURST AVG POWER
OFF
etc.

F1

F2

F3

F4

F5

F6

OBW MEAS
EXECUTE
* SETUP
RETURN

SETUP
OBW % OF POWER XdB DOWN
ENTRY N% 99%
ENTRY XdB 25dB
RETURN

ADJ CH MEAS
EXECUTE
ENTRY SEPARATION 1 12.50kHz
ENTRY SEPARATION 2 25.00kHz
ENTRY CH BW 8.50kHz
* SETUP
RETURN

SETUP
METHOD TOTAL PWR
R:REF LEVEL
GRAPH ON OFF
CH_CTR_LINE ON OFF
CH_BW_LINE ON OFF
* SETUP CH
RETURN

SELECT CH
BOTH SIDES
UPPER SIDE
LOWER SIDE
OFF
RETURN



POWER
EXECUTE
ENTRY START POINT
ENTRY STOP POINT
RETURN

to the next page (F-13)

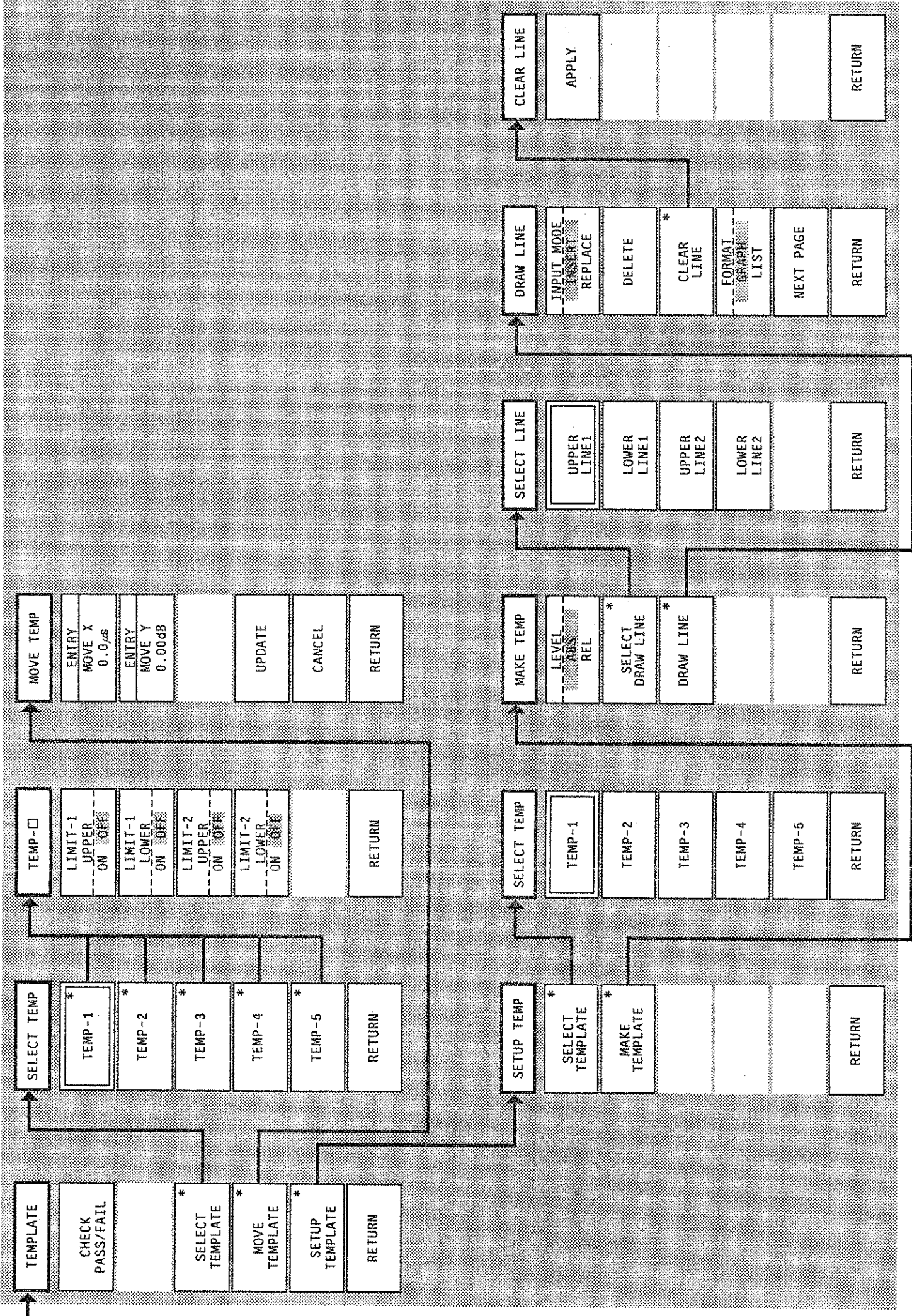
from the preceding
page (F-12)

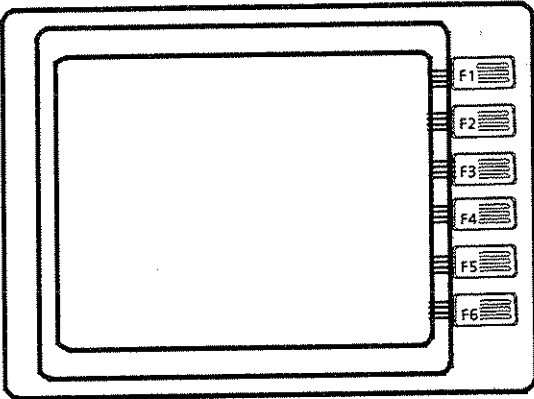
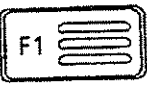
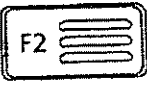
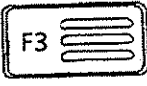
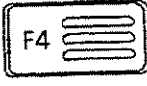

(Blank)

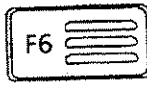

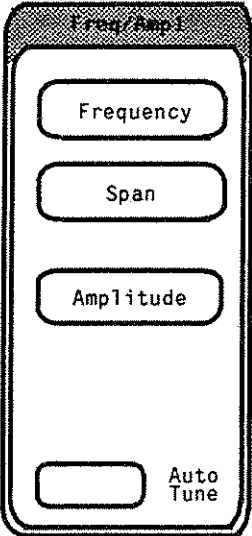
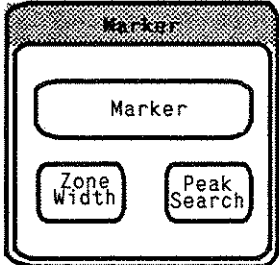

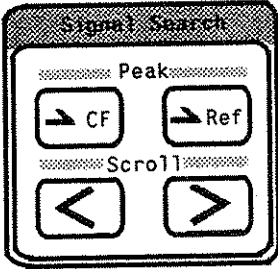
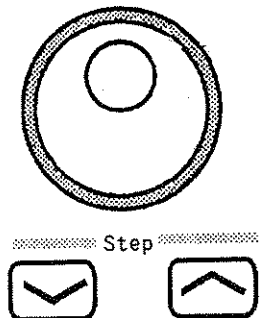
No.	Label	Explanation							
1		<p>The 400 × 600-dot 7-inch diagonal, monochrome CRT which displays the following items. Traces (graticules, markers, trace data, measurement data, etc) on the CRT are all displayed in green.</p> <ul style="list-style-type: none"> ■ Displays the information required for spectrum analysis together with signal waveform traces ● Displays principal set values of parameter settings required for measurement ● Digitally displays measured results executed with marker operations ● Displays the procedure for setting parameter ● Displays error messages 							
2	<p>GP-IB</p> <table border="1" data-bbox="321 942 493 1027"> <tr><td>ENTRY</td></tr> <tr><td>PORT1 MY ADDRESS: 1</td></tr> </table>  <table border="1" data-bbox="321 1049 493 1134"> <tr><td>ENTRY</td></tr> <tr><td>PORT2 MY ADDRESS: 16</td></tr> </table>  <table border="1" data-bbox="321 1155 493 1240"> <tr><td>ENTRY</td></tr> <tr><td>MC8104A ADDRESS: 19</td></tr> </table>  <table border="1" data-bbox="321 1261 493 1347"> <tr><td>RS232C * (OPTION02)</td></tr> </table>   	ENTRY	PORT1 MY ADDRESS: 1	ENTRY	PORT2 MY ADDRESS: 16	ENTRY	MC8104A ADDRESS: 19	RS232C * (OPTION02)	<p>In Table 2 of Appendix C in this Operation Manual, the panel keys are listed in a function table corresponding to the soft keys. When one of these panel keys is pressed, the function menu corresponding to the [F1] to [F6] soft keys is displayed on the right of the screen. Then, press the soft key corresponding to the function menu, and the menu function is executed.</p> <p>< Example: Checking the current GPIB address, then changing it 3 ></p> <ol style="list-style-type: none"> 1. Press the TEN keys on the panel in order of [Shift][●] (GP-IB). 2. On the right of the screen, the GP-IB menu corresponding to the [F1] to [F6] keys is displayed as shown on the left. 3. Check that the current GPIB address is 1; the [F1] soft key label shows [PORT1 MY ADDRESS: 1]. 4. Press the [F1] soft key, and an address entry response is displayed in the communication field. Change the address value to 3 using the TEN keys numeric keypad.
ENTRY									
PORT1 MY ADDRESS: 1									
ENTRY									
PORT2 MY ADDRESS: 16									
ENTRY									
MC8104A ADDRESS: 19									
RS232C * (OPTION02)									



No.	Label	Explanation
3		<p>Freq / Ampl: This section is used to enter the parameter data for frequency and level.</p> <ul style="list-style-type: none"> • [Frequency]: When this key is pressed, the current CENTER FREQUENCY value is displayed in the communication field. Use the TEN keys, rotary knob, or [√] / [^] keys to change the center frequency data. When the [Frequency] key is also pressed, the function menu for frequency setting is displayed on the right of the screen. From this menu, it possible to select the frequency setting mode, set the selected-mode frequency, or set the frequency step size using the [√] / [^] keys. • [Span]: When this key is pressed, the current FREQUENCY SPAN value is displayed in the communication field. Use the TEN keys, rotary knob, or [√] / [^] keys to change the frequency span data . When the [Span] key is also pressed, the function menu for frequency band is displayed on the right of the screen. • [Amplitude]: When this key is pressed, the current REFERENCE LEVEL value is displayed in the communication field. Use the TEN keys, rotary knob, or [√] / [^] keys to change the reference level data. When the [Amplitude] key is also pressed, the function menu for level range setting such as reference level unit, vertical axis scale, and so on is displayed on the right of the screen. • [Auto Tune]: Automatically detects the maximum peak point within the preset frequency band (BG band) and moves the peak point to the horizontal axis center.
4		<p>Marker: This section is used to select and execute various marker functions (marker position, peak search, marker mode, and zone marker).</p> <ul style="list-style-type: none"> • [Marker]: When this key is pressed, the current marker ZONE CENTER value is displayed in the communication field. Use the TEN keys, rotary knob, or [√] / [^] keys to move the zone marker position. When the [Marker] key is also pressed, the function menu for the marker functions such as marker mode, marker-set parameters, and so on is displayed on the right of the screen.

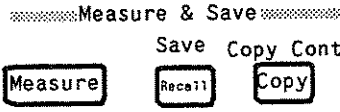
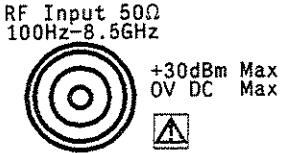

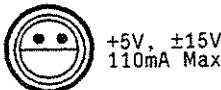

No.	Label	Explanation
4 (cont.)		<ul style="list-style-type: none"> ● [Zone Width]: When this key is pressed, the ZONE WIDTH of zone marker can be changed using the TEN keys, rotary knob, or [√]/[^] keys. The zone width can be lengthened or shortened from the reference point of the zone center. ● [Peak Search]: When this key is pressed, the marker moves to the maximum level of the currently-displayed spectrum. Select the appropriate function menu displayed on the right of the screen, then the marker moves to the next largest peak or smallest peak relative to the currently-detected peak.
5	 <p>The diagram shows a rectangular menu titled "Signal Search". It is divided into two sections: "Peak" and "Scroll". The "Peak" section contains two buttons: "→ CF" and "→ Ref". The "Scroll" section contains two buttons: "←" and "→".</p>	<p>Signal Search: This section is used to quickly and efficiently search for the point where a desired signal is obtained.</p> <ul style="list-style-type: none"> ● [→ CF]: Searches for the maximum level signal frequency on the horizontal axis of the screen and sets its signal to the center. ● [→ Ref]: Searches for the maximum level signal on the horizontal axis of the screen and sets its signal to the reference level. ● [<] [>]: When the [>] key is pressed, the waveform being displayed is moved to the right; when the [<] key is pressed, the waveform is moved to the left. The frequency width movement is specified by the frequency menu SCROLL STEP SIZE displayed when the [Frequency] key is pressed.
6	 <p>The diagram shows a rotary knob with a central circle and an outer ring. Below it is a menu titled "Step" with two buttons: a downward-pointing chevron (∇) and an upward-pointing chevron (∧).</p>	<ul style="list-style-type: none"> ● Rotary knob: Changes data for moving the marker, setting frequency and reference level in modes where data entry is permitted. ● [∇] [∧]: Steps up and down parameter data such as frequency, level, marker, and coupled function in modes where data entry is permitted.

No.	Label	Explanation
7		<p>These 18 keys including numeric keys, unit keys, BS (Back Space) key, and Shift key are called TEN keys for convenience.</p> <ul style="list-style-type: none"> • [0]~[9],[.],[+/-]: Numeric keys used to set numeric data. • [GHz / dBm / dB] : These are unit keys and are used to complete numeric entries when pressed. • [MHz / V / sec] • [kHz / mV / msec] • [Enter / Hz / μV / μsec] : The [Enter] key is used to complete the data entry without unit (e.g. GPIB address etc). • [BS]: This is a backspace key which erases the last character each time it is pressed, and is used to correct wrong spellings. • [Shift]: To execute the functions labelled with blue characters above the front panel keys, first press the [Shift] key, then press the appropriate blue character key for the desired function. The Shift key LED lights when the [Shift] key is pressed and goes off when the blue character key is pressed. • [Cal]: Displays the menu for correcting level and frequency errors. Press the [Shift] key, then the [0] key to display the menu. The menu also contains the 1⁻ and 1⁺ bands in which the pre-selector is used for band selection. • [GP-IB]: Displays the menu for setting the external interface conditions including the GPIB and other interfaces. Press the [Shift] key, then the [.] key to display the menu. • [PMC]: Displays the menu for managing the external and internal PMCs. Press the [Shift] key, then the [+ / -] key to display the menu. • [Parameter]: Displays the menu for listing the MS2602A measurement conditions and the internal parameters settings. Press the [Shift] key, then the [1] key to display the menu. • [System]: Displays the menu for setting the MS2602A operating conditions such as sweep time settings, data point selection, and other settings. Press the [Shift] key, then the [2] key to display the menu.

No.	Label	Explanation								
7 (cont.)		<ul style="list-style-type: none"> • [Title]: Displays the menu for selecting the title ON / OFF, characters, and others displayed at the top of the graticule. Press the [Shift] key, then the [3] key to display the menu. • [Sound]: Displays the menu for selecting the modulation mode and volume control during modulated wave reception. Press the [Shift] key, then the [4] key to display the menu. When a modulated wave (AM or FM) is received, the MS2602A can detect and monitor voice-modulated signals. The voice can be heard from a built-in speaker, and earphone or an external speaker connected to the phone terminal. 								
8	<p style="text-align: center;">~~~~~ Coupled Function ~~~~~</p> <table style="margin-left: auto; margin-right: auto; border-collapse: collapse;"> <tr> <td style="text-align: center; padding: 2px;">•Auto RBW</td> <td style="text-align: center; padding: 2px;">•Auto VBW</td> <td style="text-align: center; padding: 2px;">•Auto Swp Time</td> <td style="text-align: center; padding: 2px;">•Auto Atten</td> </tr> <tr> <td style="text-align: center; border: 1px solid black; width: 30px; height: 20px;"></td> <td style="text-align: center; border: 1px solid black; width: 30px; height: 20px;"></td> <td style="text-align: center; border: 1px solid black; width: 30px; height: 20px;"></td> <td style="text-align: center; border: 1px solid black; width: 30px; height: 20px;"></td> </tr> </table>	•Auto RBW	•Auto VBW	•Auto Swp Time	•Auto Atten					<p>Coupled Function: In an initial setting state, the four control settings between RBW (Resolution Bandwidth), VBW (Video Bandwidth), Swp Time (Sweep Time), and Atten (Attenuator) are set to AUTO mode so that the MS2602A itself can select optimum control settings automatically. In AUTO mode, each lamp over the four keys lights. If the coupled function is executed in manual mode as follows, then the lamps go off.</p> <ul style="list-style-type: none"> • [RBW]: Displays the current RBW values in the communication field when this key is pressed. Use the TEN keys, rotary knob, or [√]/[^] keys to change the data. • [VBW]: Displays the current VBW values in the communication field when this key is pressed. Use the TEN keys, rotary knob, or [√]/[^] keys to change the data. • [Swp Time]: Displays the current Sweep Time values in the communication field when this key is pressed. Use the TEN keys, rotary knob, or [√]/[^] keys to change the data. • [Atten]: Displays the current Attenuation values in the communication field when this key is pressed. Use the TEN keys, rotary knob, or [√]/[^] keys to change the data.
•Auto RBW	•Auto VBW	•Auto Swp Time	•Auto Atten							

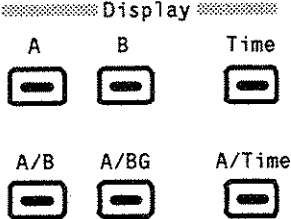
No.	Label	Explanation
9	 <p>Measure & Save</p> <p>Measure Recall Save Copy Copy Cont</p>	<ul style="list-style-type: none"> • [Measure]: Press this key to display the menu for optimizing measurements for various applications including frequency, noise, distortion, and other measurements. When this [Measure] key is pressed, the menu measurement items are displayed on the right of the screen. • [Recall]: Displays the menu for recalling setting parameters or waveform data from internal memory, PMC, or floppy disk. • [Save]: Displays the menu for saving setting parameters or waveform data to internal memory, PMC, or floppy disk. Press the [Shift] key, then the [Recall] key to display the menu. • [Copy]: Executes direct plotting in accordance with the conditions set by the [Shift] and [Copy Cont] keys. • [Copy Cont]: Displays the menu for setting the direct plotting conditions. Press the [Shift] key, then the [Copy] key to display the menu. The menu is used to select the printer and plotter models, paper size, and other items.
10	 <p>RF Input 50Ω 100Hz-8.5GHz</p> <p>+30dBm Max OV DC Max</p>	<p>Applies the signal to be measured to the RF Input N type connector. Signal with a frequency range of 100 Hz to 8.5 GHz and measurement level of -135 to +30 dBm can be measured. Since the input circuit is not protected, applying an excessive input signal which exceeds +30 dBm or 0 Vdc may burnout the input attenuator or input mixer.</p> <p>The  alert symbol is a warning not to apply such an excessive input signals.</p>
11	 <p>Probe Power</p> <p>+5V, ±15V 110mA Max</p>	<p>Supplies power to a probe, such as the Tektronix P6201 high impedance probe (sold separately).</p>
12	 <p>Phone</p>	<p>Outputs an AM or FM demodulation signal from the Phone terminal by pressing the [Shift] and [Sound] keys. The sound from the built-in speaker cuts off when an earphone (3.5 Ø miniature plug) is plugged into this Phone terminal.</p>
13	 <p>Keyboard</p>	<p>Connector for connecting the G0044 PTA keyboard (sold separately) to control PTA. The keyboard can also be used to enter title characters.</p>

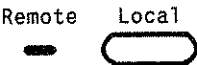
No.	Label	Explanation
14	<p style="text-align: center;">~~~~~ Sweep Control ~~~~~</p> <p>Zone Swp Tracking Gate</p>  <p>Restart Continuous Free Run</p> 	<p>Sweep Control: This section is used to set the MS2602A sweep conditions (trigger, gate, zone sweep, tracking, and others).</p> <ul style="list-style-type: none"> • [Zone Swp]: Pressing this key provides zone sweep mode, which sweeps only the frequency range encircled by the zone marker. To release the zone sweep mode, press the [Zone Swp] key again. The LED on top of the key lights orange during zone sweep. • [Tracking]: Pressing this key provides tracking mode, which tracks the center frequency to the frequency change. To release the tracking mode, press the [Tracking] key again. The LED on top of the key lights orange during tracking mode. • [Gate]: Menu key for the gate used to analyze intermittent signals such as pulse-modulated waves and burst waves. The LED on top of the key lights orange during tracking mode. • [Stop]: Stops the sweep operation under sweep. • [Restart]: Restarts the sweep stopped by pressing the [Stop] key. Press the [Shift] key, then [Stop] key to restart. • [Single]: Executes a single sweep each time the [Single] key is pressed. • [Continuous]: Executes continuous sweep. Press the [Shift] key, then [Single] key. The MS2602A initially operates in continuous sweep mode. • [Trig]: Pressing this key sets the sweep-starting conditions to TRIGGERED. The sweep-starting mode is determined in accordance with the trigger conditions set by the function menus displayed on the right of the screen. Four types of trigger source can be selected: VIDEO, LINE, EXT, and TV. • [Free Run]: Pressing the [Shift] key, then the [Trig] key sets the sweep-starting condition to FREE RUN. The sweep-start condition is initially set to FREE RUN.

No.	Label	Explanation
15	<p style="text-align: center;">Display</p> 	<p>This section is used to select the display mode for tracing a waveform on the screen. There are four types of display modes: BG, A, B, and Time. Either one or two types of waveform together can be displayed.</p> <ul style="list-style-type: none"> • [A]: Displays Trace A alone. MAX / MIN HOLD, AVERAGING, DET MODE switching, and others can then be set using the function menus displayed on the right of the screen. • [B]: Displays Trace B alone. The same functions as for key [A] can be set using the function menus displayed on the right of the screen. (The frequency relationship between Trace A and Trace B is the same.) • [Time]: Displays the time-domain waveform of the center frequency on a frequency spectrum waveform. Like the [A] and [B] keys, functions can be set using the function menus. • [A / B]: Simultaneously displays Trace A and Trace B. • [A / BG]: Detects the desired signal from a wide frequency range by simultaneously displaying Trace A and BG (Background). • [A / Time]: Simultaneously displays Trace A and the time-domain waveform of the center frequency of Trace A.
16	<p style="text-align: center;">Intensity</p> 	<p>Controls the brightness of the entire screen. Turning the knob clockwise brightens the screen; turning the knob counterclockwise darkens the screen.</p>
17	<p style="text-align: center;">Remote Local</p> 	<p>The Remote lamp comes on when the MS2602A is placed in remote mode to control the GPIB using software. Provided that this remote mode is not RWLS (Remote With Lockout Status), the MS2602A can be switched from remote mode to local mode and the lamp goes off when the [Local] key is pressed. If the remote mode is RWLS, the MS2602A cannot be returned to local mode even if the [Local] key is pressed. Conversely, it is impossible to switch from local mode to remote mode by using the [Local] key.</p>
18	<p style="text-align: center;">Preset</p> 	<p>Initializes the MS2602A panel function parameters to a known, preset value regardless of their current values, except for some conditions such as interface conditions and system settings.</p>
19	<p style="text-align: center;">PTA</p> 	<p>Displays the PTA function menus on the right of the screen and the LED on top of the PTA key lights when the [PTA] key is pressed.</p>

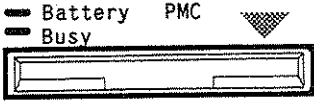
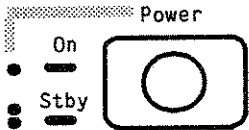
No.	Label	Explanation
20		<p>PMC (Plug - in Memory Card) slot: Plug the PMC into this slot with the PMC side facing the arrow shown on the left. The PMC is used as an external memory. It is also used as a PTA program memory or a data memory.</p> <ul style="list-style-type: none"> ● Battery: This warning lamp indicates the battery life built in the PMC while the SRAM type PMC is plugged into the PMC slot. When the Battery lamp lights red, it indicates that the battery has run out. Replace the battery with the PMC plugged into the slot. ● Busy: The Busy lamp remains lit while the PMC is being accessed during reading and writing data from and to the MS2602A CPU. Do not unplug PMC during access.
21		<p>Switch for turning on and off the power to the MS2602A only when the rear-panel power switch (No. 26) is ON.</p> <ul style="list-style-type: none"> ● On: When this button is pressed in while the rear panel power switch is ON, the power is turned on and the orange ON lamp lights. Power is supplied to all the MS2602A circuits and the MS2602A is then ready to be used. ● Stby: When this button is pressed again during the power-on state, it pops out to the standby position. If the rear panel power switch is on, power is then supplied only to the internal reference crystal oscillator circuit and the green Stby lamp lights.

(Blank)

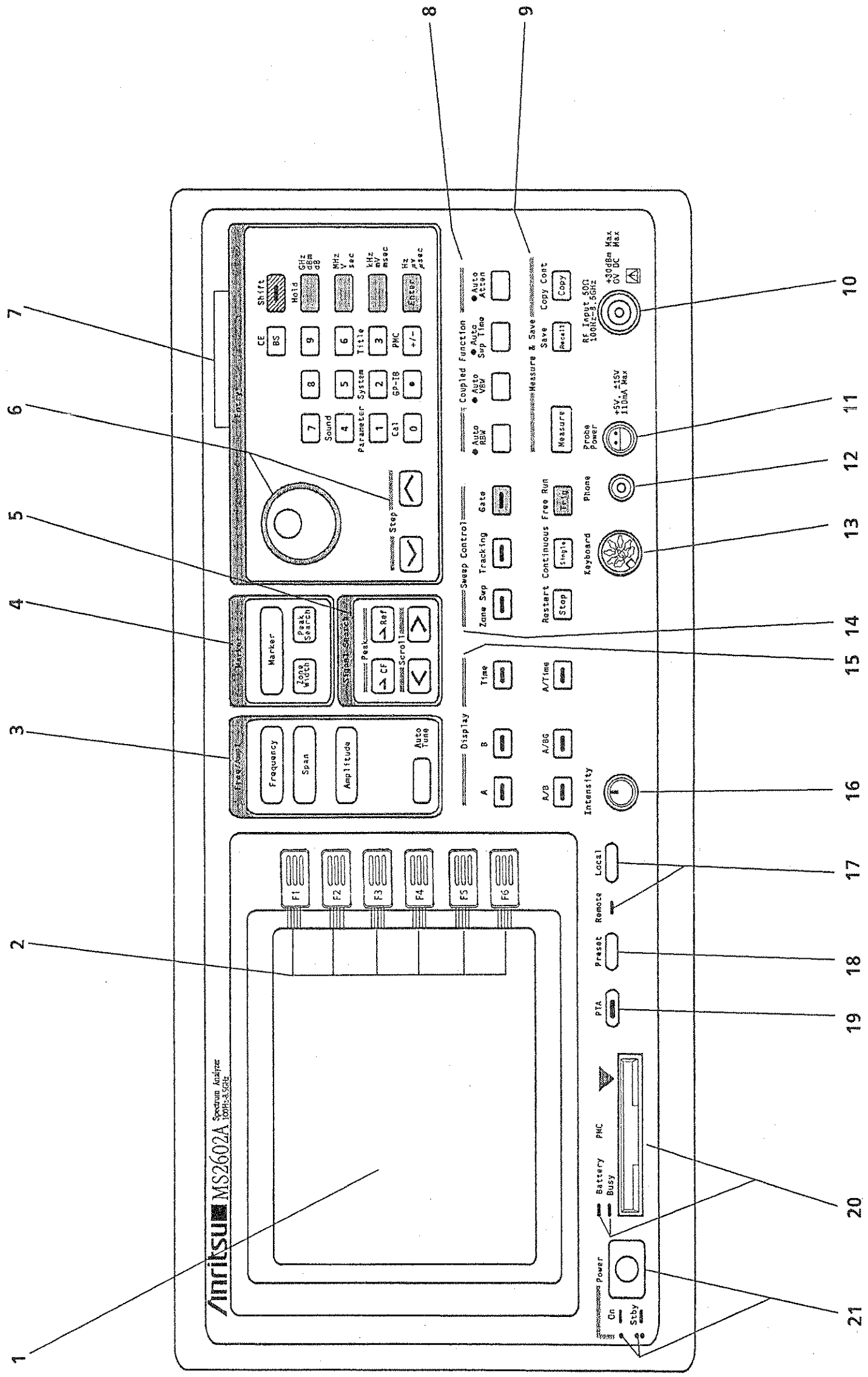
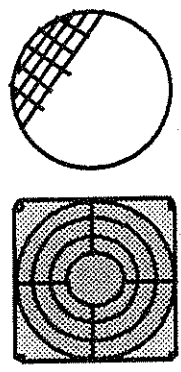
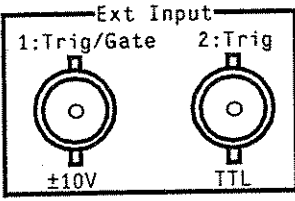
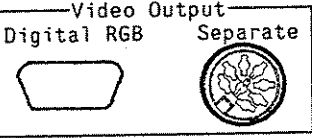
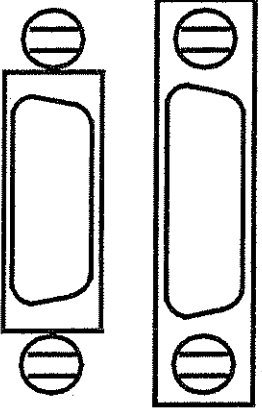
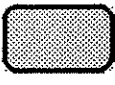

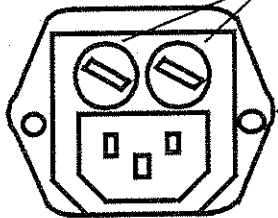
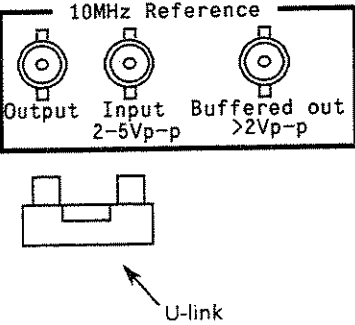
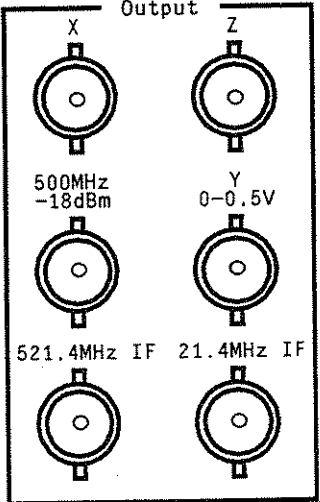

Fig. F-1 Front Panel

(Blank)

No.	Label	Explanation
22		<p>Fan for exhausting the heat generated inside the MS2602A to outside.</p> <p>Allow a clearance of 10 cm or more between the fan and nearby objects.</p>
23		<p>Ext Input: This section is used for connectors to input external trigger signals used when the trigger source is set to EXT or the gate function is set to ON.</p> <ul style="list-style-type: none"> • 1: Trig / Gate: Connector for inputting an external trigger signal used when the external trigger input is set to INPUT 1: Trig / Gate (± 10 V). The connector is also used for inputting a gate trigger signal when the gate function is set to ON. • 2: Trig: Connector for inputting an external trigger signal when the external trigger input is set to INPUT 2: Trig (TTL).
24		<p>Video Output: This section is used for connectors to output screen information to an external monitor or video plotter.</p> <ul style="list-style-type: none"> • Digital RGB: Connects a color monitor with the Digital RGB input. Six colors are used for the following display items: <ul style="list-style-type: none"> Scale Red Marker Purple Text Pale blue Trace A White Trace B, BG, Time Yellow PTA screen Green • Separate: Used for hard-copying using the UA-455A / VP-1500 II Video Printer with a separate video signal input.

No.	Label	Explanation
25	<p style="text-align: center;">GP-IB 2 GP-IB 1</p> 	<p>The MS2602A has two types of GPIB interface: GP-IB 1 and GP-IB 2.</p> <p>For the GP-IB 1, connect the GPIB cable to the right connector, and for the GP-IB 2, connect the GPIB cable to the left connector.</p> <ul style="list-style-type: none"> • GP-IB 1: Used for connecting a bus so that the MS2602A can be used as a talker or listener under an external system controller. The 13 characters from SH1 to C24 beside the connector indicate the GP-IB 1 interface functions (subset). • GP-IB 2: Used for connecting a bus so that the MS2602A can be used as a system controller to control other devices using a PTA program. The 13 characters from SH1 to C28 beside the connector indicate the GP-IB 2 interface functions (subset).
26	<p style="text-align: center;">Off On</p> 	<p>Line AC power switch, which is usually used in the power-on mode.</p> <ul style="list-style-type: none"> • On: When this button is pressed in, the AC line is set to ON. If the front panel [Power] switch (No.21) is ON, power is supplied to all the MS2602A circuits and the MS2602A is ready to be used. If the front panel [Power] switch is set to Stby, then power is supplied only to the internal reference crystal oscillator circuit, so that the reference crystal oscillator oven is pre-heated and the Stby lamp on the front panel is lit. • Off: When this button is popped out by being pressing in the ON state, the AC line is set to OFF even if the front panel [Power] switch is ON.
27		<p>This terminal is connected to earth potential to prevent electric shocks.</p> <p>This is called the frame ground terminal-FG (Frame Ground).</p>

No.	Label	Explanation
28		<p>Fuse capsules</p> <p>AC power inlet. Plug in the supplied power cord here.</p> <p>The T mark indicates the fuse characteristics. It means that there is a fixed time lag before the fuse blows. This fuse meets the IEC standards. For further details, refer to IEC Pub.127 sheet III.</p>
29		<p>10MHz Reference: This section contains connectors used for synchronizing the MS2602A reference frequency with an external reference frequency or synchronizing other instruments with the MS2602A.</p> <ul style="list-style-type: none"> • Output: Outputs a 10 MHz, TTL level signal from the internal reference crystal oscillator. • Input: Used to input the signal from an external reference oscillator. When the internal reference crystal oscillator is used, the Input connector is connected by the U-link with the Output connector as shown in the figure. • Buffered out: Outputs externally the reference signal via the buffer.
30		<p>Output: This section contains the X, Y, and Z axes output connectors used to drive the X-Y recorder, the IF output connector for using MS2602A as a converter, and the 500MHz signal output connector used for checking.</p> <ul style="list-style-type: none"> • X: Outputs the X axis signal proportional to the swept voltage in the range of 0 V at the left end to 10 V at the right end. • Y: Outputs the Y axis signal proportional to the video detection voltage in the range of 0 V at the lower end to 0.5 V at the upper end. • Z: Outputs the signal in synchronization with the sweep in the TTL level. <ul style="list-style-type: none"> Being swept Low level Not being swept High level

No.	Label	Explanation
30 (cont.)		<ul style="list-style-type: none"> <li data-bbox="532 208 1352 336">● 500MHz: Used as a frequency signal source to check the instrument. The 500 MHz signal in synchronization with the reference input signal is output at approx. +18 dBm (50 Ω terminated). <li data-bbox="532 357 1352 453">● 521.4MHz IF: Outputs a 521.4 MHz IF signal. (Output level \approx Input level + 5 dB - Input attenuator setting value) <li data-bbox="532 474 1352 623">● 21.4MHz IF: Outputs a 21.4 MHz IF signal. This signal is bandwidth-limited by the setting value of RBW and logarithm-compressed during log-scale. The output level is more than -10 dBm at the top graticule.

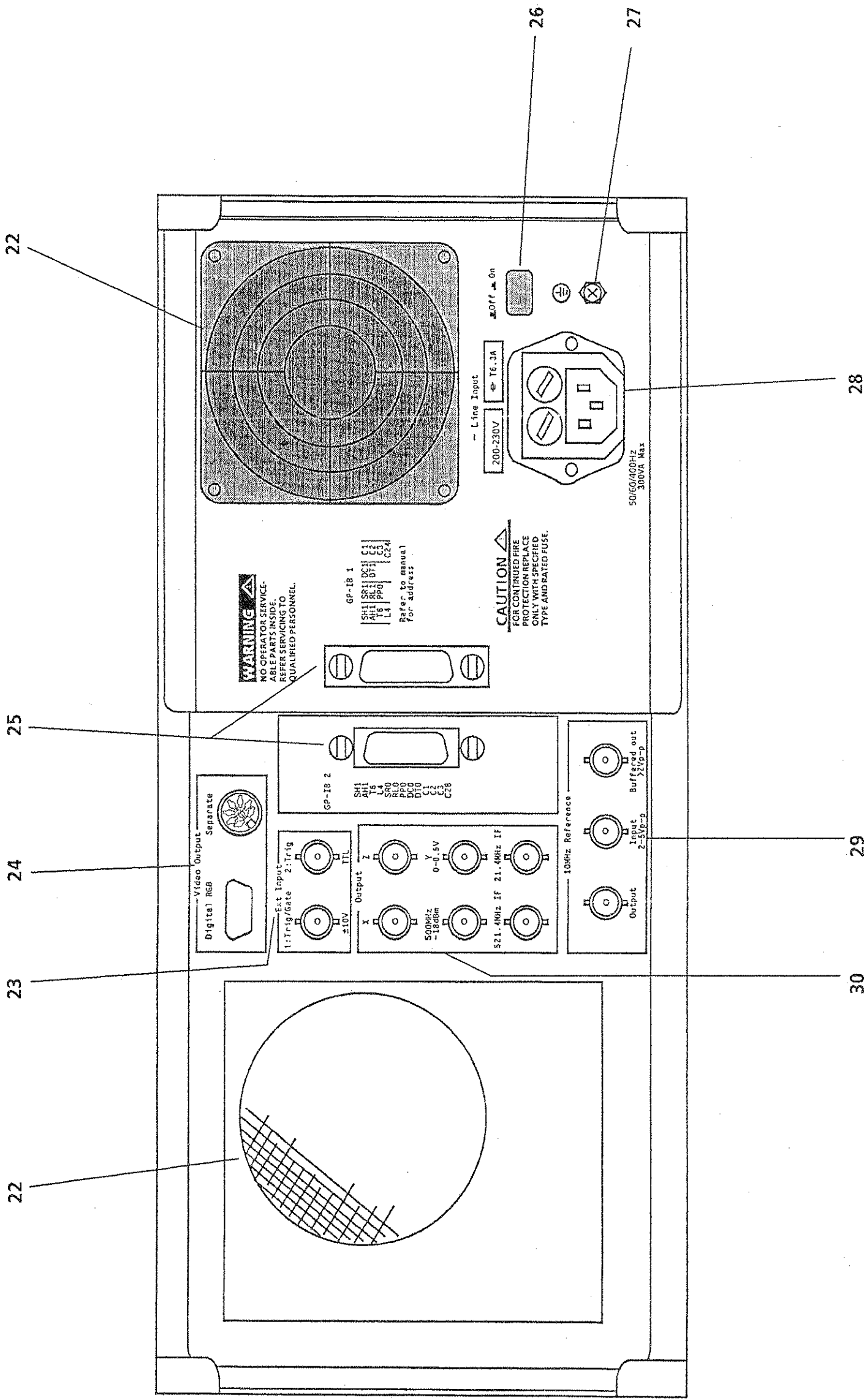

Fig. F-2 Rear Panel

(Blank)